

Hybrid Hydraulic System
[Super Unit]
SUT03S15L07-10-F
SUT03S30L07-10-F
SUT SERIES
Operation Manual



DAIKIN INDUSTRIES, LTD.

Oil Hydraulics Division

<Safety Precautions>

■ Before using this product

- Give consideration to make users thoroughly understand the contents of this operation manual.
- Please incorporate the contents of this operation manual in operation manuals for your machine using this product.
- To ensure proper operation of this unit, be sure to read this operation manual and all other attached documents carefully, to have a thorough understanding of the equipment, safety information and all other precautions before installation, operation and maintenance/inspection of this unit.
- Be sure to keep this operation manual, attached documents and delivery specifications in place, so that you can read them whenever required.
- For detailed explanation of the unit, all figures and photographs included in this manual show the unit without covers or safety shields. To operate this unit, be sure to mount the covers and shields in the specified manner, and observe the operating procedures described in this manual.
- The contents of this operation manual are subject to change appropriately for product improvement, specification change or easier operations.

The latest version of this manual is available through DAIKIN Oil Hydraulics Division Internet Service (DHCnet HomePage) ([http:// www.dhcnet.daikin.co.jp:8100/](http://www.dhcnet.daikin.co.jp:8100/)).

- This operation manual should be used as a reference that provides safety instructions for DAIKIN Hydraulic Unit. In addition to this manual, please prepare safety references for your machine to ensure safe operations and maintenance in accordance with various standards and norms.

■ Conventions of safety instructions in this manual

- In this manual, safety instructions are classified into three categories: “▲ DANGER”, “▲ WARNING” and “▲ CAUTION”.

▲ DANGER: Improper handling regardless of this indication causes an urgently hazardous condition that may result in death or serious injury.

▲ WARNING: Improper handling regardless of this indication causes a potentially hazardous condition that may result in death or serious injury.

▲ CAUTION: Improper handling regardless of this indication causes a potentially hazardous condition that may result in medium or slight injury, or property damage.

- Even an item indicated as “▲ CAUTION” may result in a serious accident depending on the situation. All instructions given in this manual include important information. Be sure to observe all of them.

■ Safety precautions

◆ General precautions

▲ DANGER

- Transportation, installation, piping, wiring, operations, maintenance and inspections must be conducted by qualified personnel.
- During the above work, wear protective gear required for safe work (work clothes, safety band, helmet, safety shoes, gloves and so on).
- Do not use this unit under conditions other than those specified in the catalog or delivery specifications.

▲ CAUTION

- Be sure to conduct daily inspections (described in this manual or attached documents).
- Do not apply external force to this unit. (Do not step on, or pound on this unit.) Otherwise, you may suffer from injury, or the unit may be damaged.

<Escape Clauses>

- DAIKIN shall not be responsible for any damage attributable to a fire, earthquake, third party's action and other accidents, as well as customer's intention, misuse or use under abnormal conditions.
- DAIKIN shall not be responsible for any damage incidental to use of this product or impossibility to use this product (loss of business profit, discontinuation of business).
- DAIKIN shall not be responsible for any accident or damage attributable to negligence in observing the instructions given in the operation manual or delivery specifications.
- DAIKIN shall not be responsible for any damage attributable to malfunction caused by combinations of this unit and external equipment.

<Limitations on Applications>

- If a failure or malfunction of this unit may directly threaten human life, or this unit is used for equipment that may cause injury to the human body, such an application must be considered depending on the case.
- This unit has been manufactured under strict quality control. However, when it is used for important equipment, the equipment must be provided with a safety device to prevent malfunction of this unit from resulting in serious accident or damage.

Contents

[1. Introduction].....	5
[2. Features and Structure].....	5
[3. Description on Model Identification Code].....	6
[4. Specifications and Operating Conditions].....	7
[5. Precautions for Use].....	8
[6. Names of Unit Components]	9
[7. Hydraulic Circuit].....	10 to 11
■ Hydraulic circuit diagram	
■ Components	
■ Piping	
[8. Precautions for Operation, Transportation and Installation]	12 to 13
■ Precautions for operation	
■ Precautions for transportation	
■ Precautions for installation	
[9. Preparations for Operation]	14 to 23
■ Filling hydraulic oil	
■ Electric wiring	
■ I/O signal cable specifications	
[10. Test Run].....	24
[11. Operation Panel Operating Procedure].....	25 to 34
■ Outline of functions	
■ Description on individual modes	
■ Shift between individual modes	
■ Operating procedure for each mode	
a) Monitor mode	
b) Setting mode	
c) Alarm mode	
■ Alarm code display list	
[12. Maintenance]	35 to 40
■ Periodic inspection	
■ Cleaning and replacement	
■ Oil cooler maintenance procedure	
■ Oil filling port (air breather) maintenance procedure	
■ Suction strainer maintenance procedure	
[Attachment: Safety Valve Adjusting Procedure].....	41
[Attachment: Power-ON External I/O Signal Timing Chart].....	42 to 48

[1. Introduction]

Thank you for selecting **IPM Motor Drive Hydraulic Unit <Super Unit>**.

Using the oil hydraulic technology and energy-saving IPM motor drive system that DAIKIN originally developed, the **IPM Motor Drive Hydraulic Unit <Super Unit>** provides overwhelmingly excellent energy conservation performance and advanced functions.

Before using the **SUT Series <Super Unit>**, please read this manual thoroughly, and handle and maintain this unit properly, so that this unit can retain excellent performance for a long period.

The components of this unit may be modified for the purpose of quality/performance improvement or other reasons. In such a case, some parts of this product may be different from those described in this manual.

[2. Features and Structure]

- Multi-stage speed control/Multi-stage pressure control, and shockless control functions
 - The Super Unit enables multi-stage pressure control/flow rate control by selecting 16 patterns of P-Q characteristics that have been registered in the controller from the master machine (via a contact input).
 - The Super Unit enables shockless control by setting/adjusting the rising/falling time at changes of the P-Q characteristics.

[3. Description on Model Identification Code]

(a)	(b)	(c)	(d)		(e)		(f)		(g)		(h)
SUT	03	S	**	L	07	-	10	-	F	-	*****

- (a) Series name
 - SUT: SUT series
- (b) Tank capacity
 - 03: 30 L
- (c) Pump type
 - S: Single gear pump
- (d) Maximum pump discharge rate
 - 15: 15.2 L/min
 - 30: 28.5 L/min
- (e) Maximum operating pressure
 - 07: 7.0 MPa
- (f) Design No.
 - Advances according to model change.
- (g) Use/No use of noise filter
 - F: Noise filter is used.
- (h) Non-standard control No.

MFG. No

(i)	(j)	(k)		(l)
*	*	**	-	**_*****

- (i) Design No.
- (j) Hardware revision history
- (k) Software revision history
- (l) Serial No.

<Output characteristic>

[SUT03S15L07]

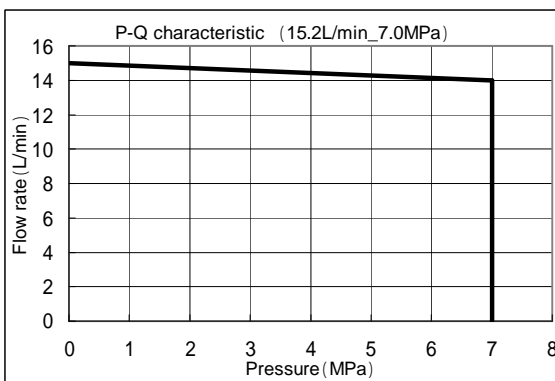

[SUT03S30L07]

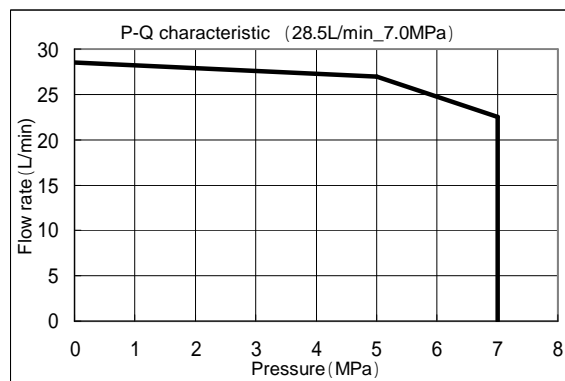

[4. Specifications and Operating Conditions]

■ Major specifications

		SUT03S15L07	SUT03S30L07
Maximum operating pressure	(MPa)	7.0	
Maximum discharge rate ^(Note 1)	(L/min)	15.2	28.5
Operating pressure adjusting range	(MPa)	1.5 to 7.0	
Operating discharge rate adjusting range ^(Note 1)	(L/min)	2.4 to 15.2	3.4 to 28.5
Power supply ^(Note 2)		3φ 200V/50Hz, 200V/60Hz, 220V/60Hz	
External input signal	(5ch)	Photo-coupler insulation, 24 VDC (27 VDC max.) 5 mA/ch	
External output signal	Alarm output (1ch)	Relay output Contact capacity: 30 VDC, 0.5 A (Resistance load) 1c contact	
	Digital output (2ch)	Photo-coupler insulation, open-collector output, 24 VDC, 50 mA max./ch	
Standard paint color		DAIKIN white (Munsell code 5Y7.5/1)	

(Note 1)

- Before shipment from the factory, the unit has been set to the maximum discharge rate. (The maximum discharge rate is a theoretical value, not a guaranteed value.)
- For details on the factory settings, see the initial values given in the setting range table on **p. 32**. For other specifications, see **the delivery specification drawing (model drawing)**.
- The upper limit of the pressure adjusting range is higher than the maximum operating pressure. However, make sure that the pressure setting does not exceed the maximum operating pressure shown above.
- This hydraulic unit incorporates a safety valve, which has been set to work at 7.5 MPa (maximum operating pressure + 0.5 MPa).
- However, if the surge pressure during actuator operation must be minimized, adjust the pressure setting according to “Attachment: Safety Valve Adjusting Procedure” on p. 41.

(Note 2)

- Power supply voltage fluctuation tolerance range is $\pm 10\%$. Even if the power supply voltage fluctuations are within the tolerance range, when the power supply voltage fluctuates in the positive direction, the regenerative overload (alarm stop) may occur in response, depending on the master machine operating conditions and load conditions.

■ Operating conditions

Hydraulic oil ^(Note 3)	Dedicated mineral hydraulic oil / Wear-resistant hydraulic oil (For recommended brands, see DAIKIN “Hydraulic Equipment General Catalog (HK196)”.) • Viscosity grade: ISO VG 32 to 68 • Pollution degree: NAS Class 9 or lower level • Viscosity range: 15 to 400 mm ² /s
Tank oil temperature	0 to 60°C (Recommended operating temperature range: 15 to 50°C) ^(Note 4)
Operating ambient temperature	0 to 35°C
Storing ambient temperature	-20 to 60°C
Humidity	80% RH or less
Installation place	Indoor (Be sure to fasten the unit with bolts.)
Others	• Be sure to mount a no-fuse breaker and earth leakage breaker. • Make sure that the electric wiring conforms to European Norm EN60204-1. • If you frequently turn ON/OFF the power supply for this unit, the controller service life will be remarkably deteriorated. If you intend to start and stop the unit frequently, use the control stop function of this unit. • Be sure to connect the ground terminal.

(Note 3)

- This unit can use only mineral hydraulic oil. (Water-containing or synthetic oil such as water-glycol cannot be used.)

(Note 4)

- When the tank oil temperature exceeds the recommended operating temperature range, pressure pulsation may be increased, or the discharge rate may be decreased. However, such phenomena do not indicate abnormality.

[5. Precautions for Use]

- (1) The motor pump of this hydraulic unit is mounted via vibration suppressing rubber that prevents motor pump vibration from being conveyed to the unit.
The pump should be connected to the unit with a hose.
- (2) This hydraulic unit is equipped with a fan motor to cool the hydraulic oil and the motor.
To ensure spaces for air intake and exhaust, do not place an obstacle at 10 cm or shorter distance from the fan motor air intake and exhaust planes.
- (3) This hydraulic unit incorporates a check valve that provides an orifice in the discharge line. If high response is required for machine pressure release or other purpose, the machine must be provided with an additional pressure release circuit.
If the load volume is large, you may hear a fluid flow sound from this orifice when the unit is stopped. However, this phenomenon does not indicate abnormality.
- (4) This hydraulic unit uses an IPM motor, which generates counter-electromotive force during changeover (regenerative operation). If the motor is frequently turned ON/OFF in the operating condition that easily generate counter-electromotive force, it causes regenerative overload, resulting in unit stop.
- (5) This hydraulic unit is equipped with a safety valve.
This safety valve has been set to a specified pressure before shipment. However, the set pressure of the safety valve may decrease while the machine is repeatedly used for a long period, or due to contaminants in the hydraulic oil.
If this unit is continuously used with the safety valve activated, it may output an alarm due to a temperature rise and so on.
In this case, re-adjust the safety valve pressure setting according to “Attachment: Safety Valve Adjusting Procedure” on p. 41.
For protection of peripheral equipment (actuator, pressure gauge, etc.) of the master machine, it is recommended that the safety valve pressure setting should be “Unit pressure setting + 0.5 MPa” in order to suppress surge pressure.

[6. Names of Unit Components]

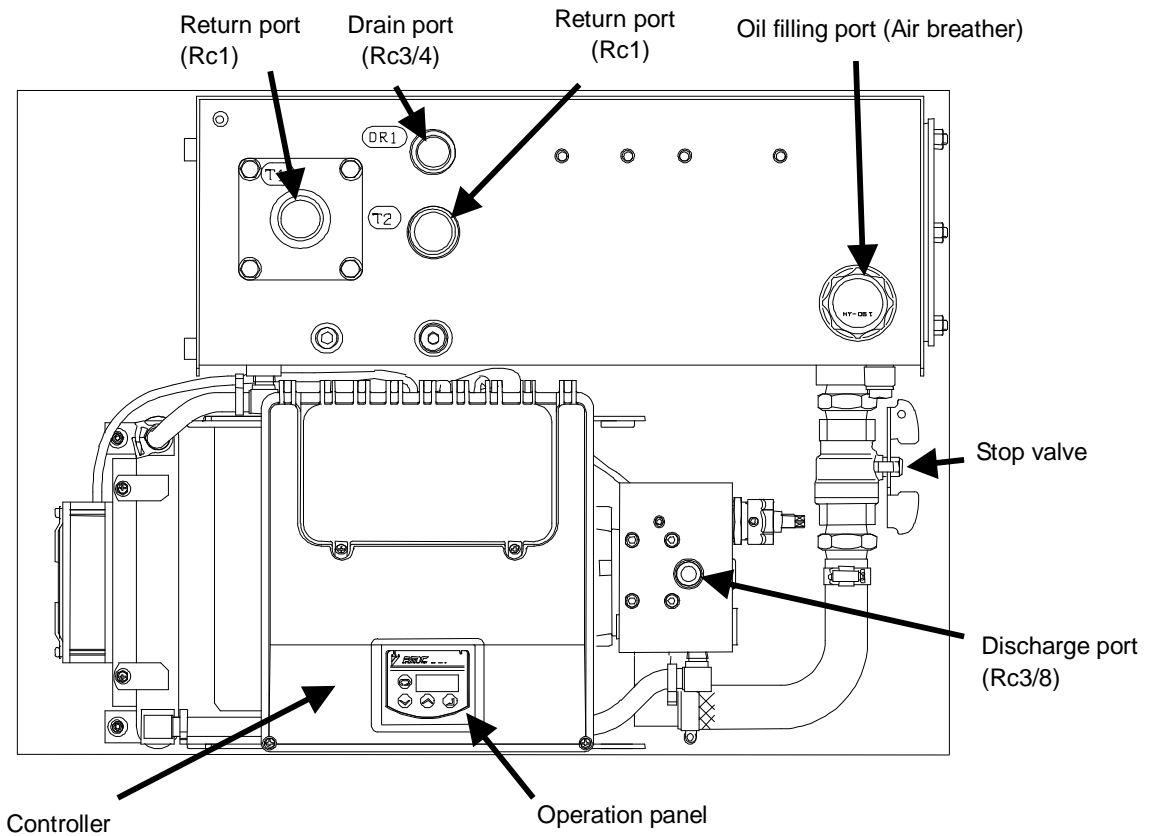

<Unit top view>

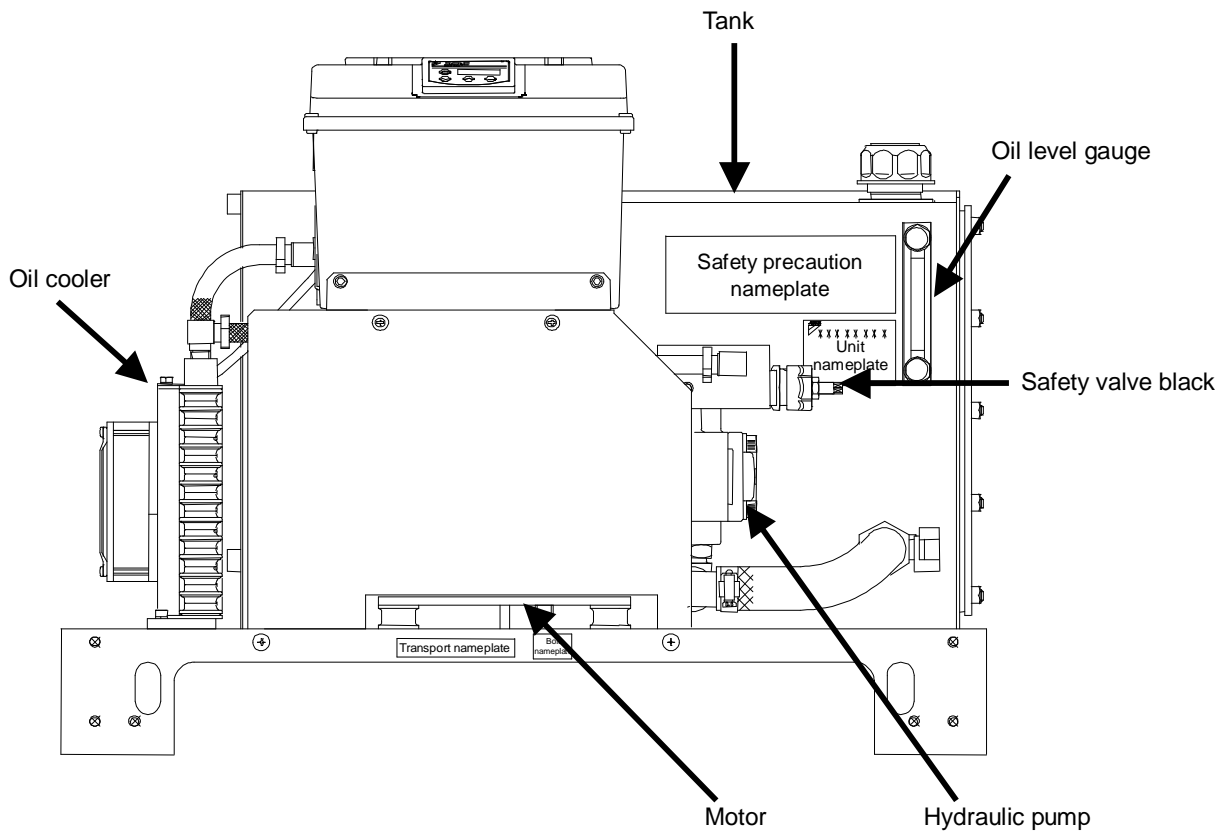

<Unit front view>

[7. Hydraulic Circuit]

■ Hydraulic circuit diagram

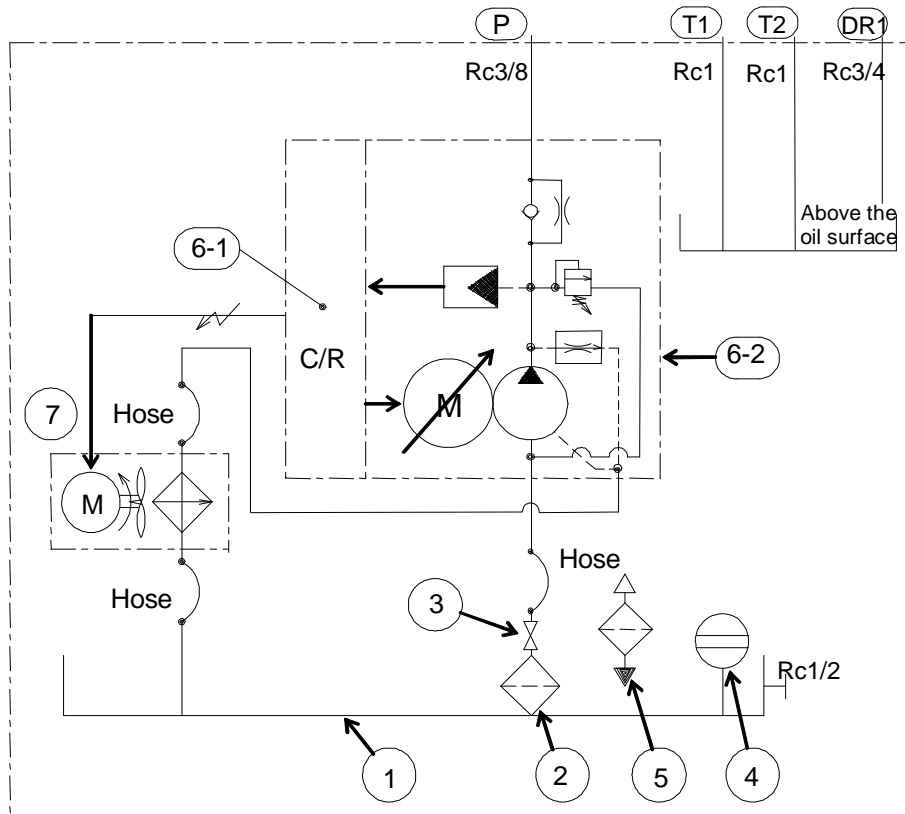

■ Components

Part No.	Name
1	Tank
2	Suction strainer
3	Stop valve
4	Oil level gauge
5	Oil filling port (Air breather)
6-1	Controller
6-2	Inverter drive pump
7	Oil cooler

■ Piping

This hydraulic unit is equipped with two return ports (submerged in the oil), one drain port (above the oil surface) and one discharge port. Connect pipes with these ports as required.

Each piping port has been covered with tapered cap (vinyl cap) before shipment.

Fasten each pipe connection by winding sealing tape.

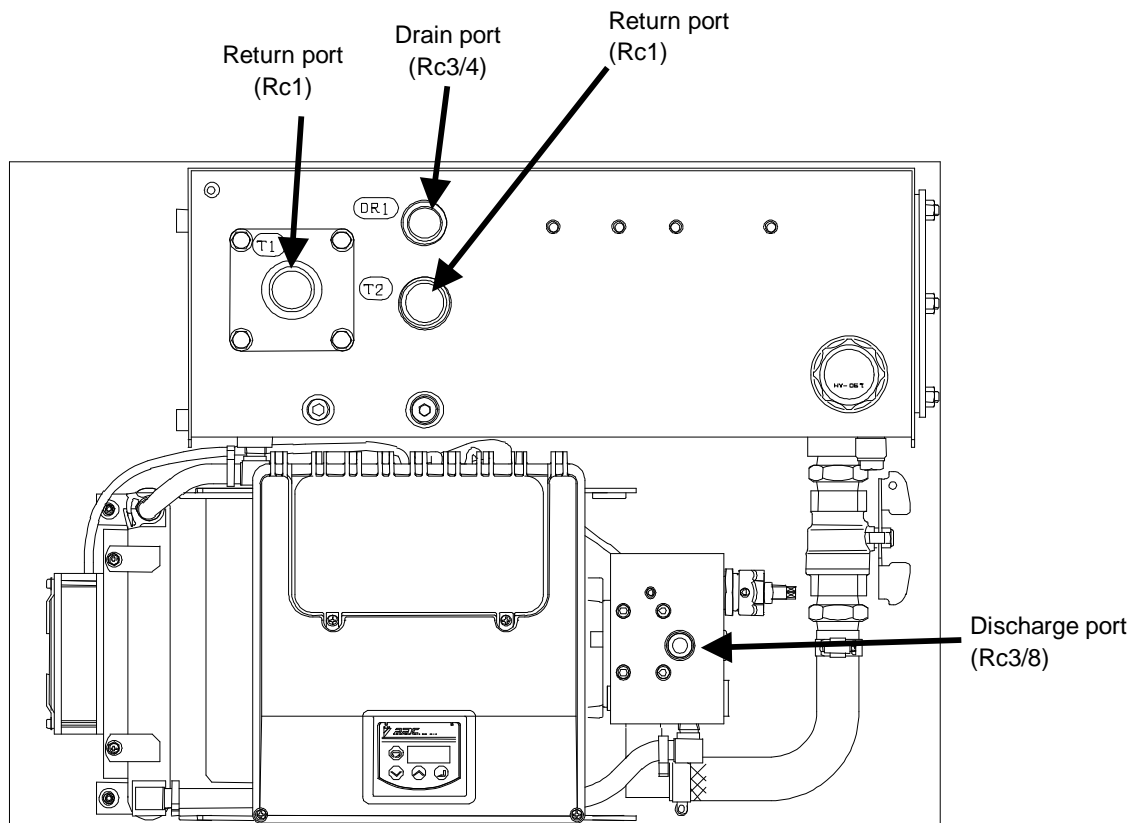

<Unit top view>

▲ CAUTION

- This hydraulic unit incorporates a check valve. If an additional inline check valve is mounted to the discharge port, resonance occurs, which may have bad influence on the master machine. Therefore, **do not use an inline check valve.**

[8. Precautions for Operation, Transportation and Installation]

In order to suppress vibration and noise, vibration suppressing rubber is attached to each mounting leg. Before shipment, it is fastened with wing bolts (M8 x L30: at two places) in order to suppress transport vibration.

■ Precautions for operation

- Before operation, remove the fastening wing bolts (M8 x L30: at two places). Operating the unit without removing the wing bolts may increase vibration and noise.

■ Precautions for transportation

- During transportation, be sure to mount the motor base to the base with the wing bolts (M8 x L30: at two places) to fasten it securely in order to protect the vibration suppressing rubber, by referring to the drawing at the right below.

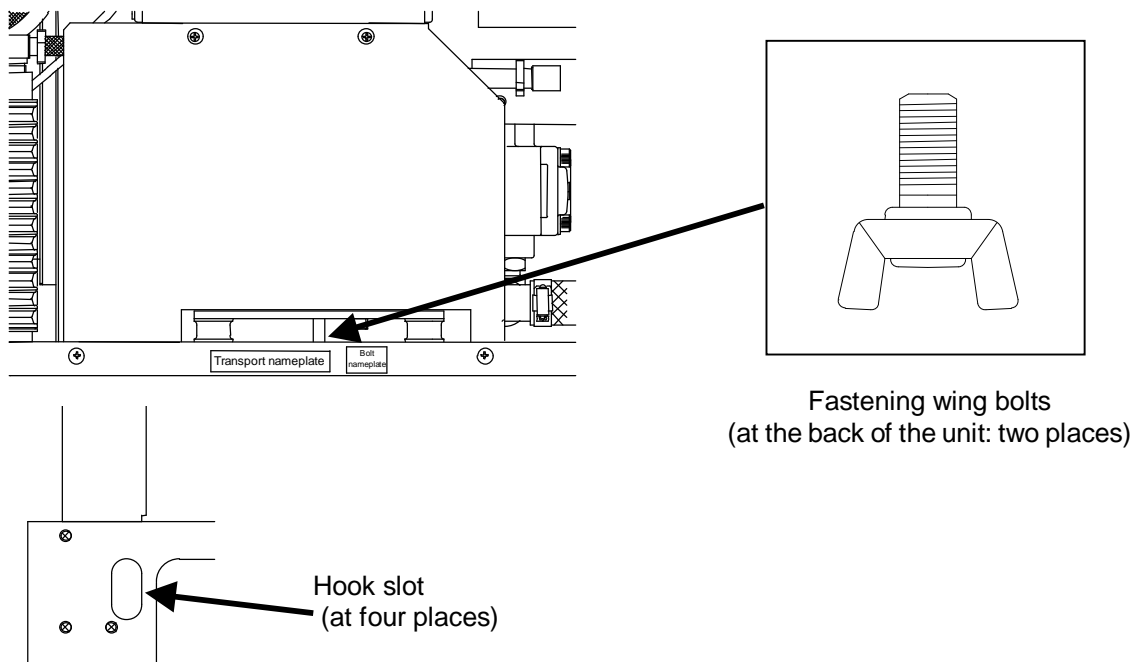

▲ DANGER

- If the hydraulic unit is lifted by any parts (e.g. pump pipes) other than the hook slots, the unit may fall or turn over.
- Check the weight of the hydraulic unit, and make sure that it does not exceed the rated load capacity of each lifting sling.

▲ WARNING

- During transportation, make sure that the unit can be evenly lifted by the hook slots at four places.
- During transportation using lifting slings, never come close to the unit. If the unit falls or turns over, you may suffer from injury.

▲ CAUTION

- Avoid transporting the hydraulic unit with hydraulic oil contained in the tank.
(This may cause oil leak, or malfunction due to air intrusion.)
- During transportation, hold the hydraulic unit securely so that it will not be moved by vibration or external force.

<Weight table> (Hydraulic oil is not included)

Model	SUT03S15L07	SUT03S30L07
Weight	65 kg	67 kg

■ Precautions for installation

◆ Securing air intake/exhaust space

Do not place an obstacle that blocks the oil cooler's air intake or air exhaust within 10 cm from the unit end surface.

Install the unit in a well-ventilated place to prevent the area around the unit from being stuffed with hot air. Make sure that the intake air temperature does not exceed the specified ambient temperature range (**35°C or lower temperature**).

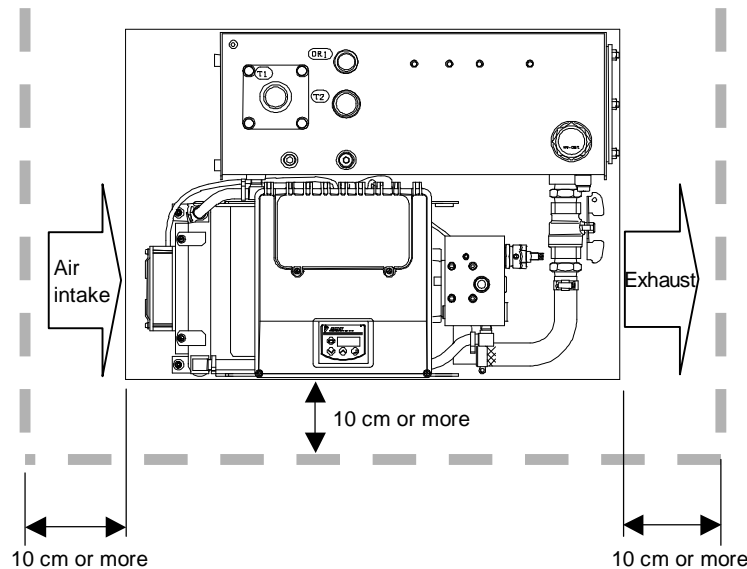

▲ WARNING

- If the hydraulic unit is used in a place without an air intake/exhaust space, or a place stuffed with hot air, the oil cooler/fan motor's heat exchanging function will deteriorate, causing the hydraulic oil and equipment to become extremely hot.
- If you accidentally touch the hot parts, you may get burns.

▲ CAUTION

- If the hydraulic unit is used in a place without an air intake/exhaust space, or where hot air is stuffed around the unit, the motor and controller become hot, causing the equipment service life to be remarkably shortened.
- When the motor or controller becomes hot, the temperature protection function is activated to stop operation. (When the motor or controller becomes extremely hot, the alarm/warning signal will be output.)
- If the hydraulic unit is continuously used at a high temperature, the hydraulic equipment (pump, valves, etc.) will have defects or shortened service life, as well as the electric components described above.
- Using the hydraulic unit at a high temperature accelerates deterioration of the hydraulic oil, resulting in shortened service life.

◆ Fastening onto a level plane

- Install the hydraulic unit on a level base or level floor.
- Fasten the hydraulic unit securely so that it will not shake.
- For the installation procedure and location, see the delivery specification drawing (model drawing).

▲ WARNING

- Unless the hydraulic unit is fastened with bolts, it may be turned over or moved by reaction force under the oil pressure in the pipe. Be sure to fasten the unit.

▲ CAUTION

- If the hydraulic unit is installed on an inclined plane, oil leak or air intrusion occurs, resulting in abnormal sound or shortened service life of the equipment.
Be sure to install the unit on a level plane.

[9. Preparations for Operation]

■ Filling hydraulic oil

- Remove the cap of the oil filling port (air breather) by turning it counterclockwise, and fill clean hydraulic oil (**pollution degree: NAS Class 9 or lower level**) into the tank. Set the oil level so that the float of the level gauge is between the red and yellow lines.
- Use the hydraulic oil conforming to the specifications on p. 7.
- Make sure that the stop valve is opened.

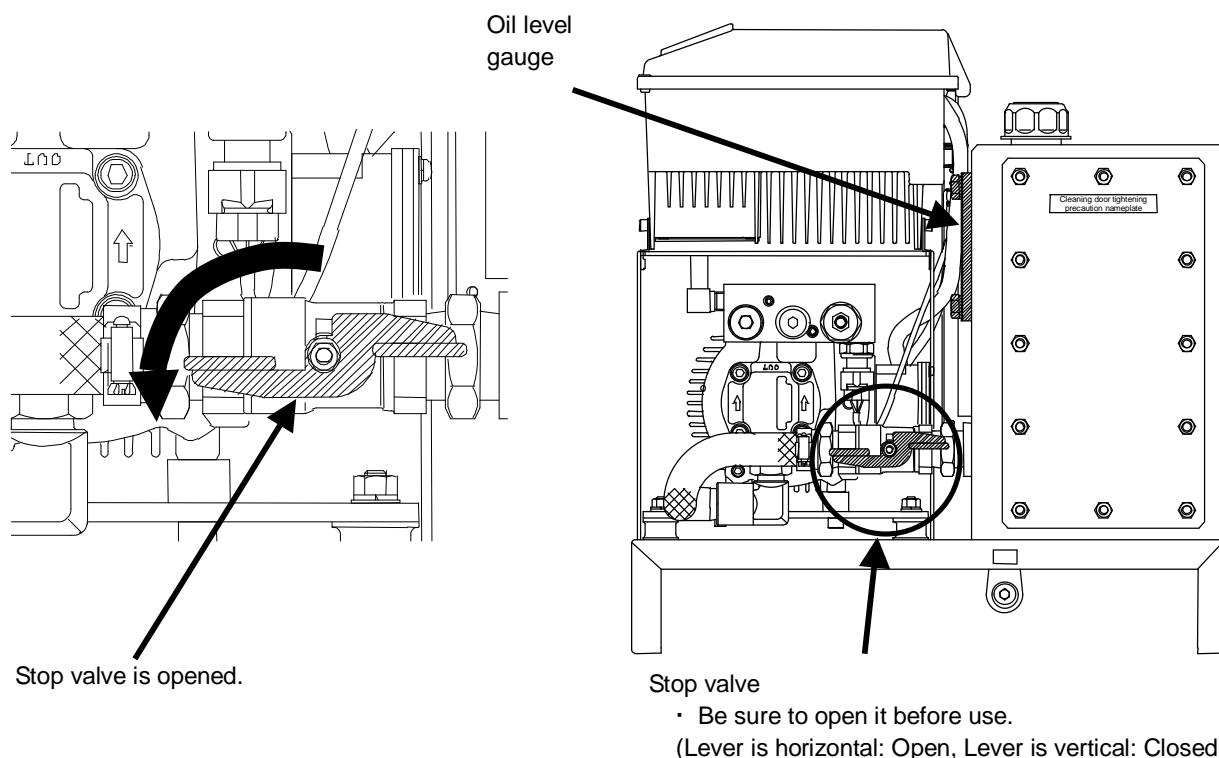

Tank capacity (L)	Oil level setting range	
	Yellow line (upper limit)	Red line (lower limit)
30	30 L	23 L

▲ CAUTION

- [1] Operating the hydraulic unit with no oil in the tank causes pump seizure or wear, which may result in pump damage.
- [2] Make sure that the stop valve is opened. If the stop valve is not opened, the oil cannot be supplied into the pump. This causes pump seizure or wear, which may result in pump damage.
- [3] During initial operation of the machine, oil will be supplied into the hydraulic circuit of the machine. Be careful about a decrease in oil level in the tank.
- [4] The oil level in the tank may largely fluctuate depending on the machine hydraulic circuit. This may result in oil leak from the tank, or decrease in oil level.

■ Electric wiring

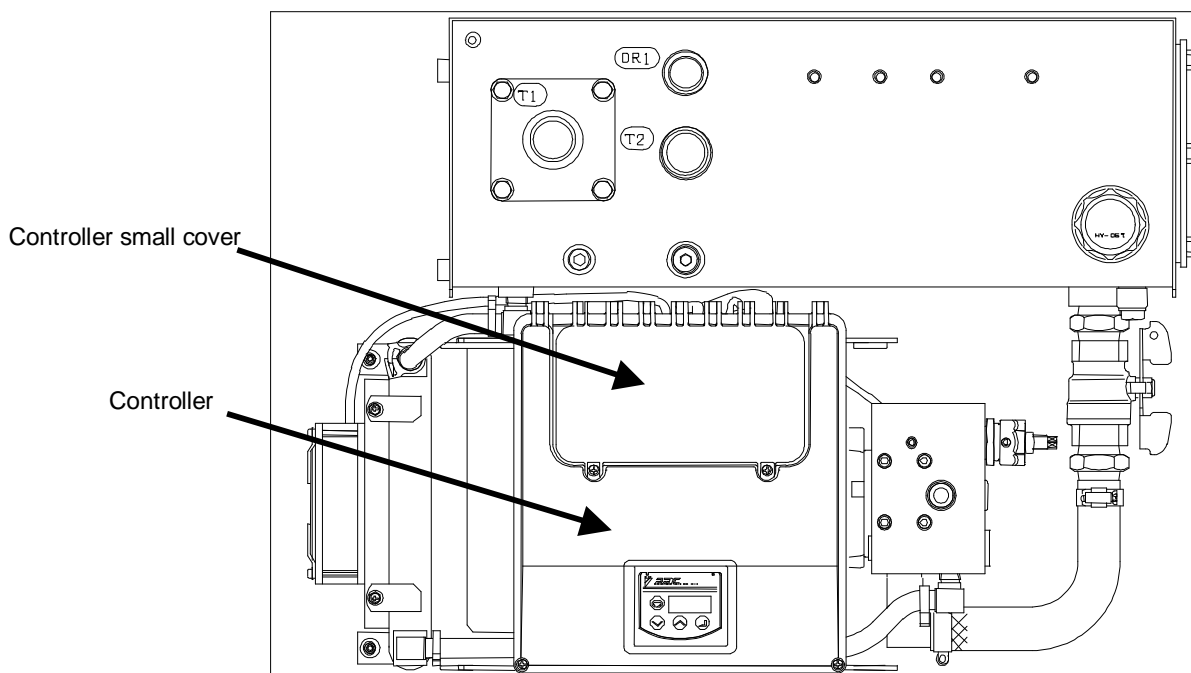

<Unit top view>

▲ DANGER

- In order to protect the electric circuit against short-circuiting and over-current and prevent electric shocks, the hydraulic unit main power supply must be equipped with a safety device (no-fuse breaker, earth leakage breaker, etc.) conforming to European Norm EN60947-2.
(For capacity of each model, see the table below.)
- Use a power supply connection device with 3-phase contact distance of at least 3 mm in the switch-OFF status.
- For connection of the ground terminal, ensure at least **Class 3 grounding condition**.
(Connect the ground terminal directly without using a breaker.)
- Be sure to complete installation of the hydraulic unit before wiring.
- Before wiring work, be sure to turn OFF the main power supply breaker, and make sure that the power is interrupted.
- Be sure not to connect the power supply cable to the I/O signal terminals.
- Do not apply an excessive power supply voltage higher than the specified power supply voltage to the hydraulic unit.
- No thermal relay is required. However, if a thermal relay is used, the hydraulic unit may malfunction due to influence of inverter switching.

▲ CAUTION

- The hydraulic unit incorporates an overcurrent protection function. Therefore, it does not need an overcurrent protection thermal relay.

[Rated current and breaker setting]

Model	Power supply voltage and frequency			Breaker setting
	3φ 200V 50Hz	3φ 200V 60Hz	3φ 220V 60Hz	
SUT03S15L07	7.9	7.7	7.1	15A
SUT03S30L07	10.9	10.7	9.7	15A

◆ Wiring procedure

To connect the main power supply and I/O signal cables, remove the small cover of the controller.

<Remove the controller small cover by loosening the cross recessed head machine screws (two M4 screws, Tightening torque: 0.6 N·m).>

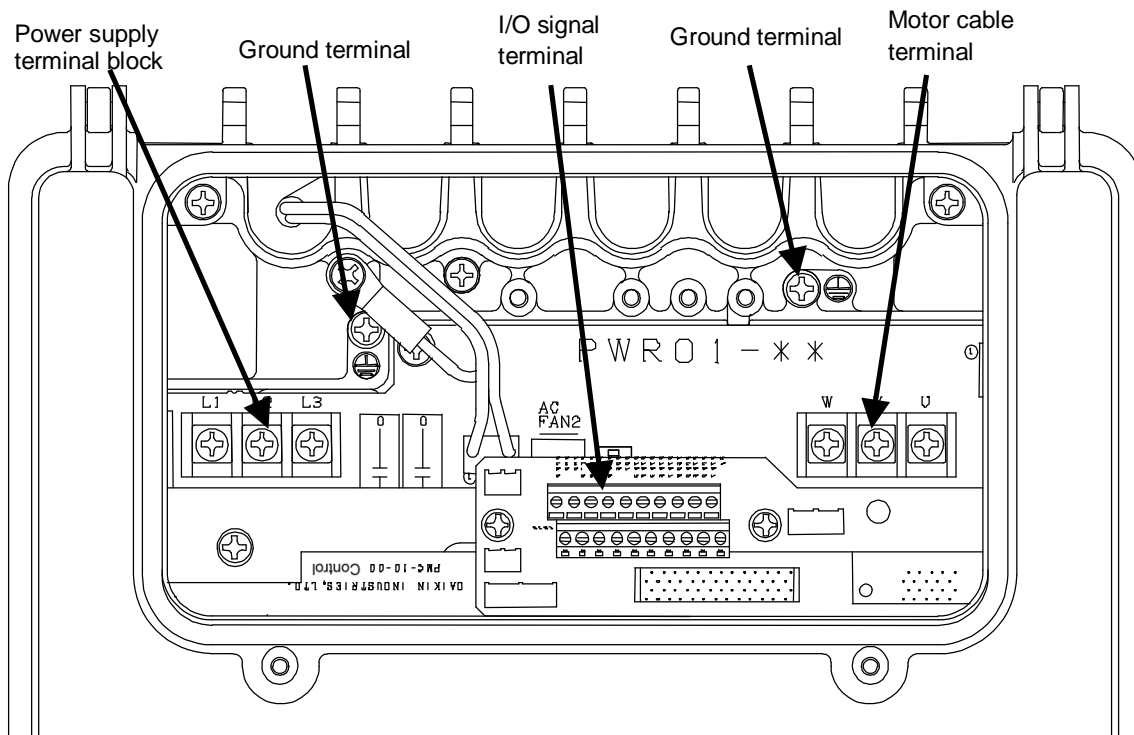
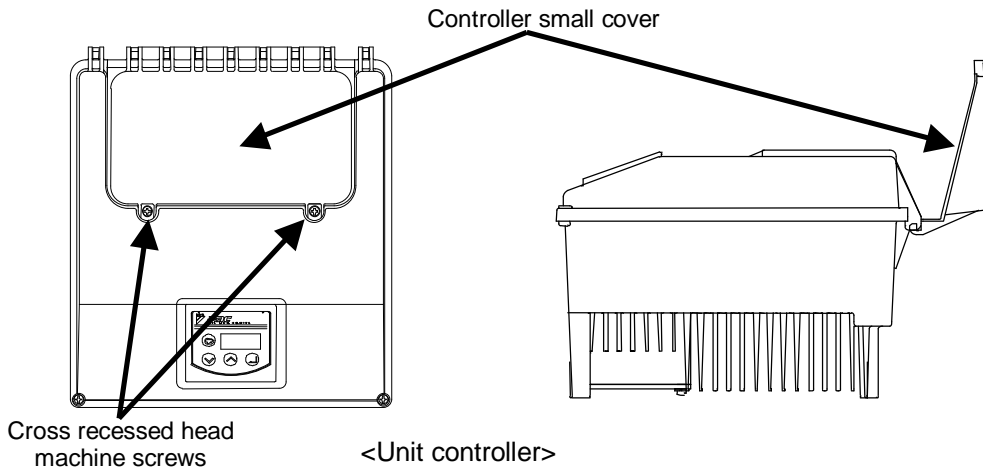

<When the unit controller small cover is removed>

▲ DANGER

- [1] To access inside of the controller, follow the procedure described below.
- i) Turn OFF the hydraulic unit main power supply.
(Turn OFF the power supply circuit breaker.)
To prevent erroneous operation during wiring work, post an "Operation Prohibited (During Work)" sign on the power supply circuit breaker.
 - ii) Remove the controller cover after elapse of at least five minutes.
The controller uses a large-capacitance capacitor. If you connect cables with the capacitor charged, you may get electric shock. Before removing the controller cover, be sure to leave the controller for at least five minutes to discharge electricity from the capacitor.
- [2] Before turning ON the power supply to start operation, mount all controller covers.

<How to use the cable clamp>

1. Loosen the tightening cap, and pass the cable through the clamp. Before this step, remove the controller fastening screw in advance.
2. Insert the cable into the controller through the controller's wiring hole.
3. Tighten the controller fastening screw to fasten the cable clamp to the controller.
4. Tighten the tightening cap to fasten the cable. The cable sheath protrusion length should be approx. 2 to 3 mm.

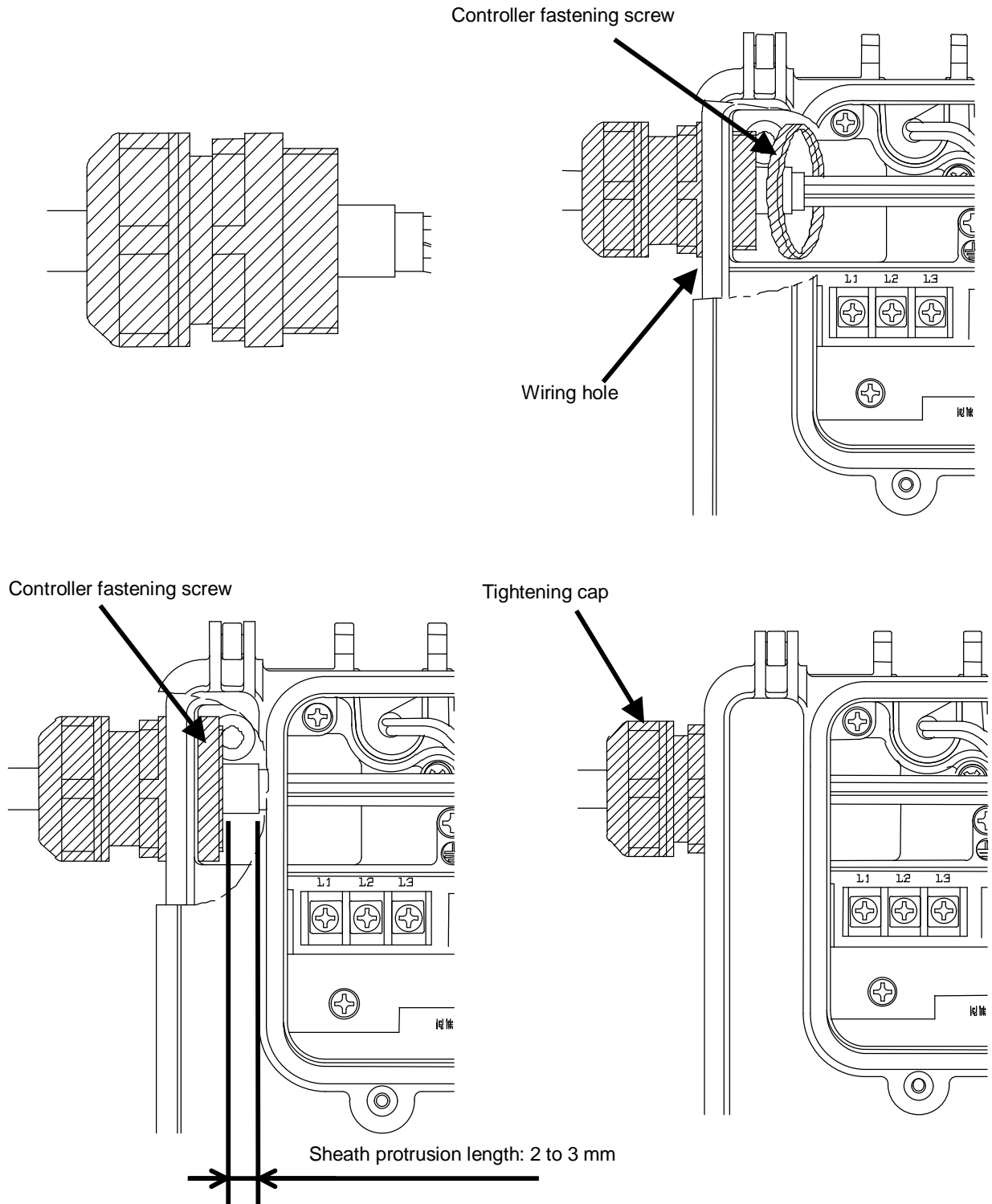

● Connecting the main power supply cable

- (1) Connect the main power supply cable to the controller through the controller's wiring hole. Use a cable clamp suitable for the wiring hole, whose protection rating should be **IP54 or higher level**. (Wiring hole diameter: 28 mm)
 - [1] Connect the ground cable to the controller's ground terminal.
 - [2] Connect the power supply cable to individual terminals on the power supply terminal block. (Tightening torque: 1.0 N·m)

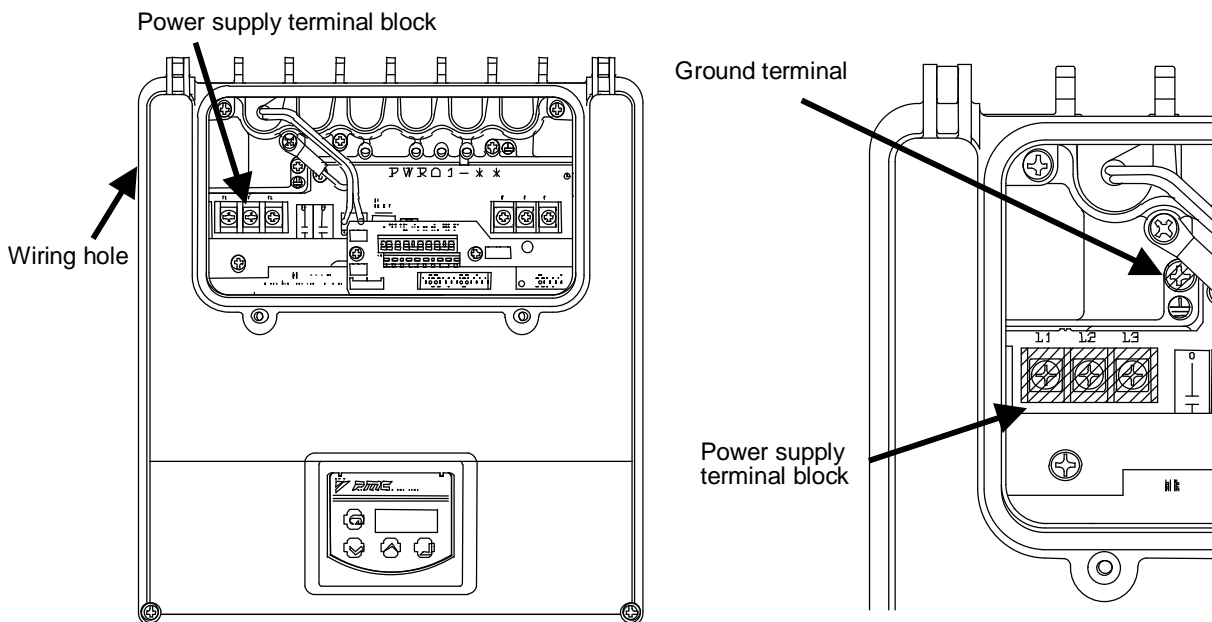

<When the unit controller small cover is removed>

<Enlarged view of power supply terminal block>

▲ DANGER

- Use an AC power supply conforming to the power supply specifications of this product.
- Use a power supply cable conforming to the power supply capacity. (See the table below.)
- Do not connect the power supply cable to the ground terminal.
- The ground terminal is connected with the motor frame. Ensure Class 3 or higher grounding condition.
- When unsheathing the cable, be careful not to damage the conductors.
- Be careful that the cable conductors do not protrude from the terminal block.

▲ CAUTION

- For connection of the power supply cable, attach a crimp terminal to the tip of the cable.
- The cable inserted into the cable clamp should be a multi-core cable as those recommended below.
If two or more cables are inserted into the clamp, the cable clamp does not conform to the specified protection rating because of a gap between the cables and the cable clamp.
- When connecting the cable, be careful not to drop a screw into the housing.

Model	Cable size	Recommended cable	Recommended crimp terminal	Recommended cable clamp
SUT03S15L07	2.5 mm ² or more (AWG14 or larger size)	CE362 2.5 mm ² x 4 cores (manufactured by KURAMO)	TMEV-2-4 (manufactured by NICHIFU)	OA-W2216 (manufactured by OHM ELECTRIC)
SUT03S30L07				

* For the power supply cable, use the 2451EC/H05RR-F cable.

<Power supply cable connecting procedure>

- [1] Unsheathe the cable by approx. 80 mm.

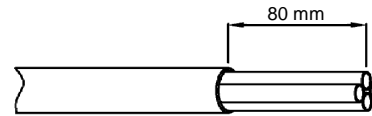

- [2] Remove the inner sheath so that the core wires are exposed by 8 to 10 mm.

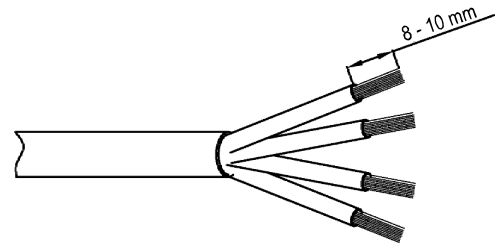

- [3] As shown on the right, crimp the round crimp terminal with insulation sheath by using a dedicated tool.

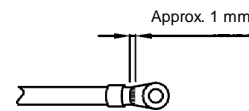

- [4] After looping each cable by one turn, connect it to the terminal block.

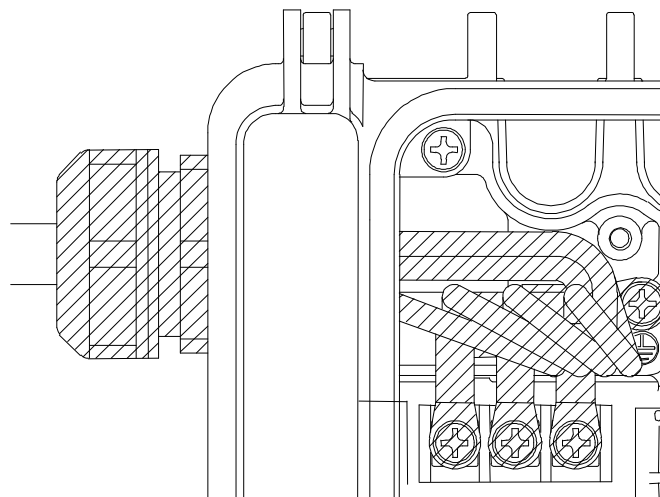
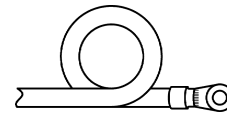

▲ CAUTION

- If the crimp tool is not suitable for the crimp terminal, the cable will come off the terminal due to a crimp failure during operation. This results in short-circuiting or burnout of the circuit caused by abnormal heating.

● Connecting the I/O signal cable

- (1) Pass the cable through a cable clamp, and connect it through the controller's wiring hole.
(Wiring hole diameter: 21 mm)
- (2) Check the specifications of individual signal lines (see p. 21), and connect the cable to the I/O signal terminal block.

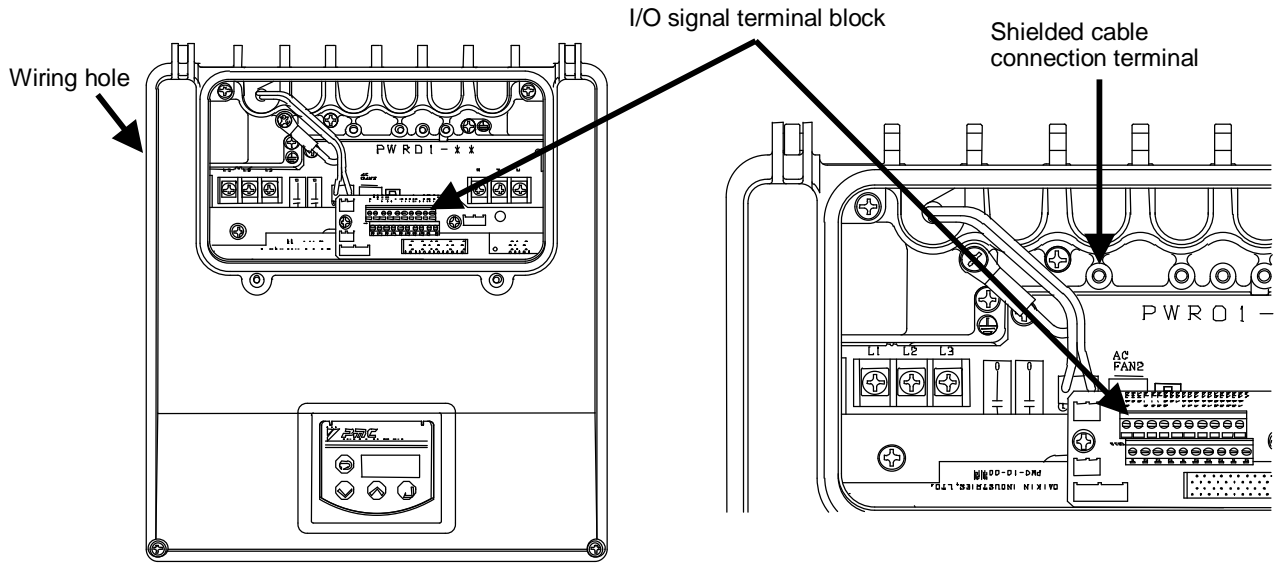

<When the unit controller small cover is removed>

<Enlarged view of I/O signal terminal block>

▲ DANGER

- Do not connect the I/O signal cable to the power supply terminal block.
- When unsheathing the cable, be careful not to damage the conductors.
- Be careful that the cable conductors do not protrude from the terminal block.

▲ CAUTION

- After checking the specifications of individual signal lines (see p. 21), connect the cable to the I/O signal terminal block.
- The cable inserted into the cable clamp should be a multi-core cable as those recommended below.
If two or more cables are inserted into the clamp, the cable clamp does not conform to the specified protection rating because of a gap between the cables and the cable clamp.
- Terminate the shielded cable securely, and connect it to the shielded cable connection terminal.

Model	Cable size	Recommended cable	Recommended cable clamp
SUT03S15L07	0.5 to 0.3 mm ² (AWG20 to 22)	KCV-36SB 0.3 mm ² (manufactured by KURAMO)	(manufactured by OHM ELECTRIC) OA-W1611
SUT03S30L07			Applicable wire outer diameter: 9 to 11 mm

- [1] Loosen the screw with a screwdriver.
- [2] Check the unsheathed length of the cable, and insert it all the way into the terminal so that the conductors will not become loose.
- [3] Tighten the screw with a screwdriver.
- [4] Pull the cable lightly to make sure that it is securely connected.

Unsheathed length of the cable: 6 mm

6

Procedure for connecting the cable to the terminal block

■ I/O signal cable specifications

The controller of this hydraulic unit provides I/O signal terminals to make an interface with external equipment. For details of each signal line, see the following pages.

Terminal No.	Type	Function of terminal	Remarks
1	No connection		These terminals are not open to users. Do not use these terminals.
11			
2			
12			
3			
13	Digital I/O terminal	Digital input common	Operations of this unit can be externally controlled. Input 1: Start/stop control input Input 2 to 5: P-Q selection by combination Selectable from 0 to 15
4		Digital input 1	
14		Digital input 2	
5		Digital input 3	
15		Digital input 4	
6		Digital input 5	
16	Digital/contact output terminal	Digital output 1	The unit status can be output. See the alarm codes on p. 34. Output 1: Complete signal Output 2: Alarm/Warning (When the alarm output combination setting [P08] is "0")
7		Digital output 2	
17		Digital output common	
8		Contract output a	
18		Contract output b	
9		Contract output common	
19	No connection		These terminals are not open to users. Do not use these terminals.
10			
20			

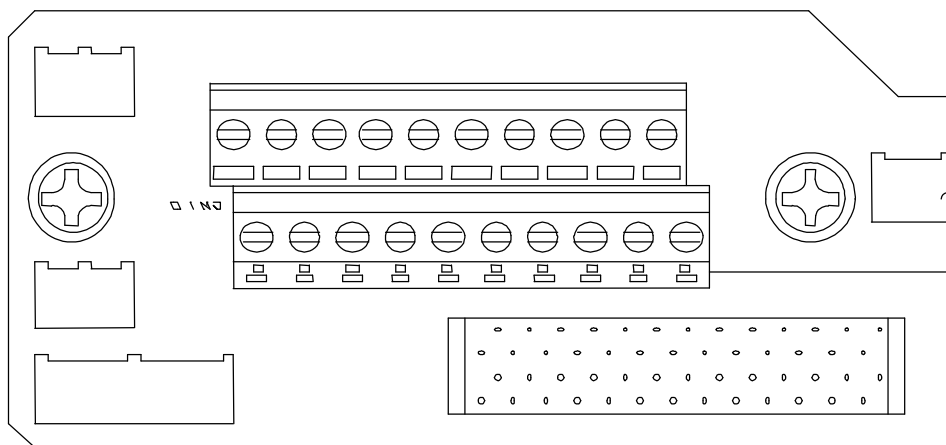

<Terminal block board in the controller>

◆ Digital input

These terminals are used for sequence input signals that control the unit operations from external equipment.

Connect these terminals as required, with reference to the table below.

Terminal No.	Signal name	Remarks
13	Digital input common	Both positive and negative signals are acceptable.
4	Digital input 1	Used for start/stop control. With the start/stop signal switching parameter (Setting mode: [P00]), you can change the operation at signal input. (See p. 29)
14	Digital input 2	P-Q selection Nos. 0 to 15 can be selected depending on the combination of digital input status. (For P-Q selection setting, see p. 29.)
	PQ 0	
5	Digital input 3	
	PQ 1	
15	Digital input 4	
6	Digital input 5	PQ 3

Note) While the unit is stopped by digital input, the panel shows “STP”.

Combination of digital inputs for P-Q selection

P-Q selection No.	Digital input 2 PQ0	Digital input 3 PQ1	Digital input 4 PQ2	Digital input 5 PQ3
0	OFF	OFF	OFF	OFF
1	ON	OFF	OFF	OFF
2	OFF	ON	OFF	OFF
3	ON	ON	OFF	OFF
4	OFF	OFF	ON	OFF
5	ON	OFF	ON	OFF
6	OFF	ON	ON	OFF
7	ON	ON	ON	OFF
8	OFF	OFF	OFF	ON
9	ON	OFF	OFF	ON
10	OFF	ON	OFF	ON
11	ON	ON	OFF	ON
12	OFF	OFF	ON	ON
13	ON	OFF	ON	ON
14	OFF	ON	ON	ON
15	ON	ON	ON	ON

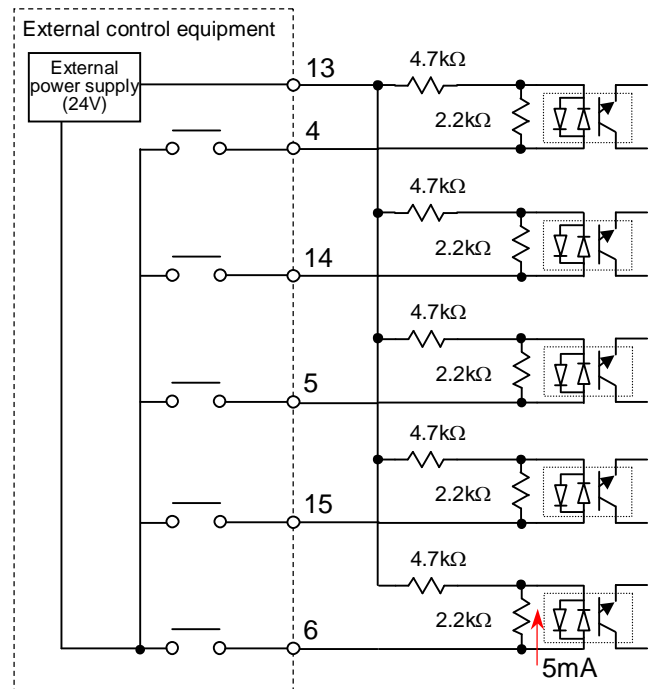

▲ CAUTION

- For the external power supply, use a power supply with **24 VDC ± 1V, 0.5 A or higher capacity**.
- Power cannot be supplied from this controller to external equipment.
- The current flowing through each input circuit is **5 mA (typical)**. To configure a circuit with a contact, be careful about the minimum current of the contact.

◆ Digital output/Contact output

These terminals are used for digital/contact output signals that output alarm status of this unit. Connect these terminals as required, with reference to the table below. For description on the outputs, see the alarm codes on p. 34.

Terminal No.	Signal name	Remarks
16	Digital output 1	Complete signal (See the timing chart in the Attachment.)
7	Digital output 2	Alarm/Warning
17	Digital output common	Negative common

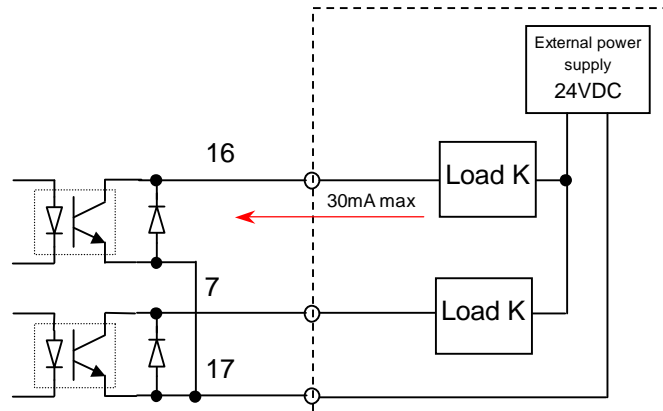

▲ CAUTION

- As the external power supply, prepare a 24 VDC \pm 1V, 0.5 A power supply. Power cannot be supplied from this controller to external equipment.
- This controller's output circuit serves as negative common.
- The maximum output current of an output circuit is 30 mA (resistance load). If you attempt to drive load higher than the allowable current, the circuit may be damaged. Pay attention to the maximum allowable current.
- To drive induction load, take surge preventive measures.

Terminal No.	Signal name	Remarks
8	Contact output a	Pressure switch a
18	Contact output b	Pressure switch b
9	Contact output common	Common

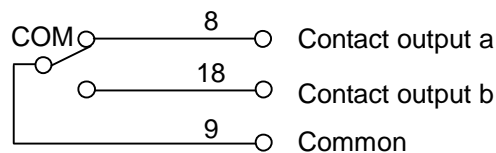

(Power ON: normal)

▲ CAUTION

- The contact output switching capacity is **30 VDC/0.5 A (resistance load)**. If you attempt to drive load higher than the allowable current, **the contact may be damaged**. Pay attention to the maximum allowable current.
- The minimum allowable load of the contact output is **10 mVDC/10 μ A**. However, it is an approximate lower limit that enables the contact to be opened/closed under minute load. This value varies depending on switching frequency and environmental conditions. We recommend you to check the minimum allowable load in actual conditions.
- To drive induction load, take surge preventive measures.

[10. Test Run]

Supply hydraulic oil into the tank to the specified level, and conduct a test run after piping and electric wiring are completed.

(Before turning ON the power supply, re-check if the ground cable and power supply cable are securely connected.)

◆ Start check

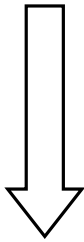

◆ Flushing

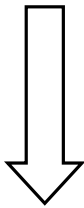

◆ Oil replacement

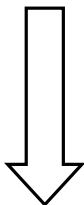

◆ Air vent

- Turn ON the switch on the machine control panel.
 - [1] Check the pump operation sound, and confirm that a pressure indicated on the display panel increases.
 - [2] Confirm that the oil cooler AC fan motor is running.

NOTE) This hydraulic unit takes a warm-up time of approx. three seconds until it starts operation after power-ON.

(The pressure rising time varies depending on the pipe volume.)

Furthermore, the hydraulic unit takes a time to increase the circuit pressure above the set pressure of the pressure switch. During this period, the pressure switch signal may be output depending on the pipe condition (pipe volume). In such a case, set up the master machine so that it does not receive the alarm output.

- After completion of the start check, set the circuit pressure at 1 to 1.5 MPa (low pressure), and flush oil through the circuit for approx. two hours. To conduct flushing operation, loop all pipes, and run the oil through a filter.
- Before flushing operation, check all pipe connections for looseness and oil leak.

- After completion of the flushing operation, check the filter for clogging. If the filter is clogged, replace the filter, and drain all hydraulic oil from tank through the oil drain port.

- Fill new hydraulic oil through the oil filling port (air breather) to the specified level.

(Use new clean hydraulic oil with pollution degree of NAS Class 9 or lower level.)

- Evacuate air from the hydraulic circuit completely. If air is not completely evacuated, the following phenomena may occur.

- [1] Abnormal operation of cylinder actuator
- [2] Abnormal sound of pump and valve





▲ DANGER

- When evacuating air, high-pressure and high-temperature oil may spout out. Pay attention to oil splash.

[11. Operation Panel Operating Procedure]

This hydraulic unit enables you to monitor or change pressure, flow rate or other parameter settings by operating the controller key switches.

■ Outline of functions

The operation panel is comprised of the 3-digit LED **8.8.8**, mode key , setting keys   and ENT key . Normally, the panel shows an actual pressure value. It can be switched between the monitor display mode and set value display mode through key operations.

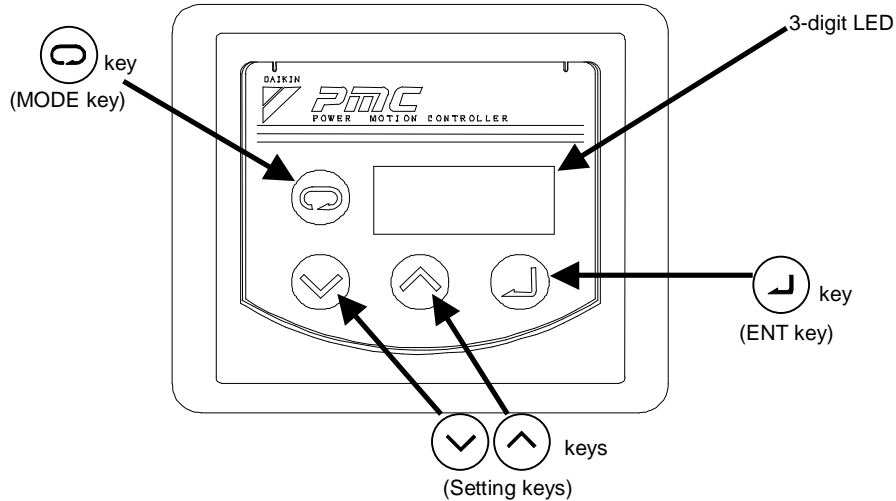

■ Description on individual modes

- Normal mode: Displays an actual pressure value or alarm code.
- Monitor mode: Displays a pressure switch set value, pressure set value, flow rate set value, actual flow rate, and actual rpm.
- Setting mode: Used to set or change a parameter such as pressure and flow rate.
- Alarm mode: Alarm records can be checked.

■ Shift between individual modes

Key switch operations for shift between individual modes are shown below:

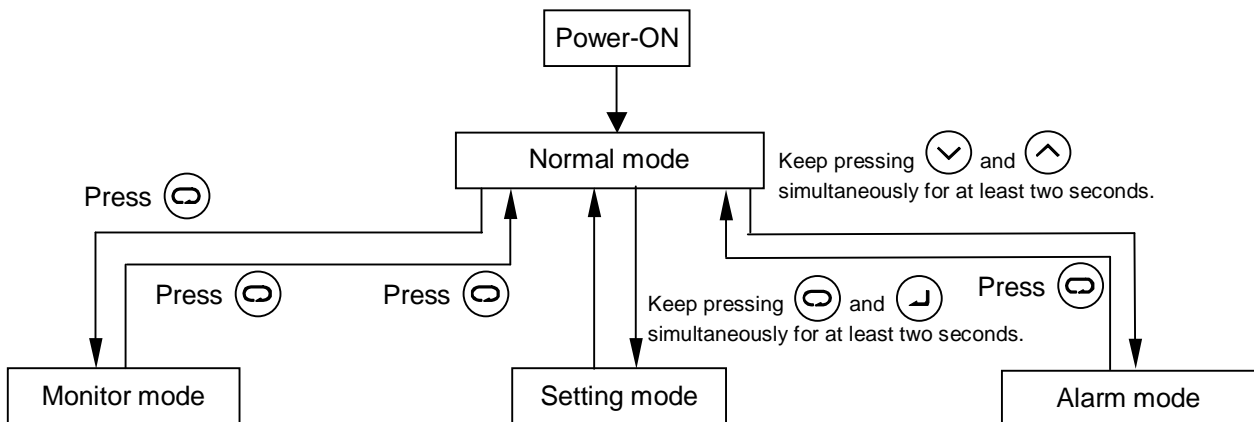

■ Operating procedure for each mode

a) Monitor mode

The monitor mode allows you to monitor a parameter by selecting a desired item from the following table.

Parameter No.	Name	Description
n00	Pressure switch setting	(MPa) [When PSI unit is selected, x 10PSI] Displays a pressure switch setting.
n01	Pressure setting	(MPa) [When PSI unit is selected, x 10PSI] Displays a pressure setting for the current P-Q selection No.
n02	Discharge rate setting	(L/min) Displays a flow rate setting for the current P-Q selection No.
n03	Discharge rate	(L/min) Displays the current discharge rate.
n04	Latest alarm code	Displays the latest alarm code.
n05	rpm	(min ⁻¹) Displays the current rpm.
n06	Operating status	Displays the current P-Q selection No.
n07	Reverse rpm at power-OFF	Displays a motor reverse rpm due to counter-flow from the load when the unit power supply is turned OFF. This parameter is used to estimate the machine load volume.
n08	Regenerative load integration ratio	Displays the load integration ratio of the current regenerative braking resistance.

Note1) With the factory setting, “MPa” is the standard unit. When it is changed to the PSI unit, attach **a label to indicate the PSI display mode.**







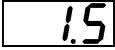

However, if the PSI unit is used in Japan, you will be punished under the Measuring and Weighing Law. The indication label should be prepared by the user.

Note 2) For details on the alarm codes, refer to description on the alarm display mode.

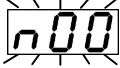
You can check **the current power-ON count** by pressing the  key when an alarm code is displayed.

An example of monitor mode operation is shown below.

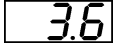
<Example> Monitoring current discharge rate

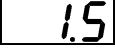
Operating procedure	Key operation	3-digit LED	Remarks
<ul style="list-style-type: none"> • Power-ON <li style="padding-left: 20px;">↓ (Startup, Run) • Actual pressure display • Shift to monitor mode 			
↓			
<ul style="list-style-type: none"> • Parameter No. selection 			Press the  key three times. Blinking
↓			Discharge rate (theoretical value) 3.6 L/min
<ul style="list-style-type: none"> • Monitor display 			
↓			
<ul style="list-style-type: none"> • Return to actual pressure display mode 			

To monitor other parameter, return to the actual pressure display mode once, and then select a desired item.

b) Setting mode

The setting mode allows you to set or change a parameter such as pressure and flow rate on the operation panel. For the parameters that can be specified or changed in the setting mode and their adjusting ranges, see the list of setting ranges on p. 32.

For the initial values and adjusting ranges of non-standard models or custom-made models, see **the delivery specifications** on separate sheets.

NOTE:

[1] The above discharge rate set value is a theoretical value (the product of theoretical displacement volume by rpm). It is slightly different from the actual discharge rate.

The setting mode allows you to set (adjust) a parameter by selecting a desired item from the following table.

Parameter No.	Name	Description
P00	Start/stop signal switching	Specify whether to run or stop the unit at signal input.
P01	Pressure switch setting	Specify whether to enable or disable the pressure switch function, and the pressure to activate the pressure switch.
P02	Pressure alarm output delay time setting	Specify the delay time until alarm output after the pressure falls below the pressure switch activating pressure.
P03	Pressure switch display hold setting	Specify the function that indicates that the pressure switch is activated. For details on this function, see “Alarm Code and Classification Table” on p. 34.
P04	Pressure unit selection setting	Used to change the unit of the normal pressure display mode (“MPa” or “x10 PSI”).
P05	Regenerative load command ratio setting	Adjust the regenerative load when it is too much increased at normal pressure response (FF → DH).
P06	AC fan motor synchronization setting	Specify whether to start or stop the radiator AC fan in synchronization with start/stop signal input.
P07	Warning output level setting	Specify a warning output level.
P08	Alarm output combination setting	Specify whether to activate the contact outputs (alarm, warning and pressure switch outputs) individually, or integrate them into one output. (See the timing chart in Attachment on p. 42.)
P09	Reset to factory setting	Resets P00 to P08 settings to factory settings.
P10	Response gain	Adjust a control response value. (A smaller value makes quicker response.)
P11	Acceleration response gain	Adjust an acceleration response value. (A larger setting makes quicker acceleration response. However, it easily causes vibration during deceleration.)
P12	Solenoid valve response delay time	Specify a solenoid valve response delay time so that a P-Q selection is synchronized with motion of the operating axis.
P13	P-Q selection 0 to 15 Pressure, flow rate, acceleration time and deceleration time settings	<p>This mode is used to set a pressure, flow rate, acceleration time and deceleration time for each P-Q selection No. Set the following items in this order:</p> <p>P <Pressure setting> q <Flow rate setting> U <Acceleration time setting> : Increases in both pressure and speed (flow rate) are simultaneously specified. d <Deceleration time setting> : Decreases in both pressure and speed (flow rate) are simultaneously specified.</p>
P14		
P15		
P16		
P17		
P18		
P19		
P20		
P21		
P22		
P23		
P24		
P25		
P26		
P27		
P28		

Normally, the P05, P10 and P11 settings need not to be changed. However, if a special circuit condition (large load volume, etc.) is expected, these settings must be changed.

- Flow rate setting changing procedure

An example of flow rate setting changing operation is shown below.

<Example> Changing flow rate for P-Q selection 1 from 28.5 L/min to 22.8 L/min.

Operating procedure	Key operation	3-digit LED	Remarks
• Power-ON			
• Actual pressure display			
• Setting mode			
• Parameter No. selection	Keep pressing two keys simultaneously for at least two seconds.		After two seconds
• Set value display	or		P-Q selection 1
• P-Q selection			Displays pressure set value for P-Q selection 1
• Changing set value	Press .		
• Writing set value	"P.01", "q.01", "U.01" and "d.01" are alternately displayed in this order.		Displays flow rate set value for P-Q selection 1
• Return to actual pressure display mode	or		

CAUTION: The flow rate setting can be arbitrarily specified in steps of 0.1 L/min.

Model	Theoretical pump displacement volume (cc/rev)
SUT03S15L07	4.0
SUT03S30L07	5.7

- Pressure setting changing procedure

An example of pressure setting changing operation is shown below.

<Example> Changing pressure for P-Q selection 1 from 1.5 MPa to 6.0 MPa

Operating procedure	Key operation	3-digit LED	Remarks
<ul style="list-style-type: none"> • Power-ON 			
<ul style="list-style-type: none"> • Actual pressure display (When "P-Q selection 1" is selected) 			
<ul style="list-style-type: none"> • Setting mode 			
	Keep pressing two keys simultaneously for at least two seconds.		After two seconds
<ul style="list-style-type: none"> • Parameter No. selection 			P-Q selection 1
<ul style="list-style-type: none"> • Set value display 			
			Displays pressure set value for P-Q selection 1
<ul style="list-style-type: none"> • Changing set value 			
<ul style="list-style-type: none"> • Writing set value 			
<ul style="list-style-type: none"> • Return to actual pressure display mode (When "P-Q selection 1" is selected) 			

- Setting range

Parameter No.	Description	Initial setting		Operating range ^{Note1}		Display unit		
		SUT03S15	SUT03S30	SUT03S15	SUT03S30			
P00	Start/stop signal switching	1		0: Run at signal input 1: Stop at signal input		-		
P01	Pressure switch setting	0		0 to 35.0 (0: Disabled)		(MPa)		
				0 to 507 (0: Disabled)		[When PSI unit is selected, × 10PSI]		
P02	Pressure alarm output delay time setting	0		0.00 to 9.99 (9.99 sec. max.)		(sec)		
P03	Pressure switch display hold setting	0		0: Disabled 1: Holds display during pressure switch activation 2: Display and memory during pressure switch activation		-		
P04	Pressure unit selection setting	0		0: MPa 1: PSI		-		
P05	Regenerative load command ratio setting	50		30 to 100		(%)		
P06	AC fan motor synchronization setting	0		0: Continuous operation 1: Synchronous operation		-		
P07	Warning output level setting	0		0: No warning output 1: Warning status output 2: Alarm equivalent output		-		
P08	Alarm output combination setting	1		0: Individual alarm output 1: Integrated alarm output See Attachment. ^{Note 6}		-		
P09	Reset to factory setting	0		0: Retains current settings 1: Reset to factory settings ^{Note 7}		-		
P10	Response gain ^{Note 2}	25	20	5 to 999 (A smaller value makes quicker response.)		-		
P11	Acceleration response gain ^{Note 2}	200		0 to 500		-		
P12	Solenoid valve response delay time	0		0.00 to 9.99		(sec)		
P13 to P28	P-Q selection 0 to 15 Pressure, flow rate, acceleration time and deceleration time settings							
	P.00 to P.15: Pressure setting ^{Note 3}		1.5		1.5 to 7.0		(MPa)	
	q.00 to q.15: Flow rate setting ^{Note 4}		22		22 to 100		(× 10 PSI)	
	U.00 to U.15: Acceleration time setting ^{Note 5}		15.2		28.5	2.4 to 15.2	3.4 to 28.5	(L/min)
	d.00 to d.15: Deceleration time setting ^{Note 5}		0.10		0.01 to 9.99		(sec/MPa) (sec/1000min ⁻¹)	
		0.10		0.01 to 9.99		(sec/MPa) (sec/1000min ⁻¹)		

Note 1 For setting or adjustment on the operation panel, a value exceeding the above operating range can be specified. However, be sure to use the unit within the specified operating range.

Note 2 If the load volume is normal, response gain adjustment is not required. If the response gain is changed to an improper value, the unit operation becomes unstable, or surge pressure may be generated.

Note 3 Make sure that the pressure setting is lower than “Safety valve setting – 0.5 MPa”.

Note 4 The flow rate setting can be arbitrarily specified in steps of 0.1 L/min.

Note 5 According to the acceleration time setting, increases in both pressure and speed (flow rate) are simultaneously specified.

According to the deceleration time setting, decreases in both pressure and speed (flow rate) are simultaneously specified.

Note 6 Specify whether to activate the contact outputs (alarm, warning and pressure switch outputs) individually, or integrate them into one output.

Note 7 1: Enables reset to factory settings. When the power supply is turned ON again, the factory settings become active.







c) Alarm mode

The alarm mode allows you to check alarm conditions listed below by selecting any item between A00 and A09.

Alarm No.	Description	Remarks
A00 to A09	Alarm code indicating alarm condition (For each code, see the attached table.)	A smaller No. indicates a later alarm.

An example of alarm mode operation is shown below.

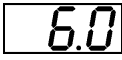
<Example> Checking an alarm condition (E01: IPM alarm) of an alarm before the latest one (A01)

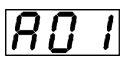
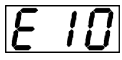
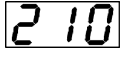
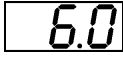
Operating procedure	Key operation	3-digit LED	Remarks
<ul style="list-style-type: none"> • Power-ON ↓ • Actual pressure display • Alarm mode ↓ • Selecting alarm No. ↓ • Displays alarm condition ↓ • Return to actual pressure display mode 	<p style="text-align: center;">  Keep pressing two keys simultaneously for at least two seconds. </p> <p style="text-align: center;"> Press  once. </p> <p style="text-align: center;">   </p>	<p style="text-align: center;">   After two seconds (Displays the latest alarm) </p> <p style="text-align: center;">  Displays an alarm before the latest one </p> <p style="text-align: center;">  ↓ ↑   </p>	<p style="text-align: right;">After two seconds</p> <p style="text-align: right;">Alarm code and power-ON count are alternately displayed at a second interval.</p>

■ Alarm code display list

The hydraulic unit incorporates alarm detecting functions that are classified as follows:

◆ Panel display, unit operation and external output signal at occurrence of trouble

Unit status	Error condition	Panel display	Unit operation	External output signal
Normal operation	[1]	Alarm No. display	Operation stop	See the table on the next page.
Power-ON (during initialization)	[2]	Alarm No. and erroneous parameter No. are alternately displayed.		
Normal operation	[3]	Warning No. and actual pressure value are alternately displayed.	Operation continued	
Normal operation	[4]	Warning No. display		

◆ Alarm codes and classification table

(Individual alarm output: When the alarm output combination setting [P08] is “0”)

(Integrated alarm output: When the alarm output combination setting [P08] is “1”)

Classification	Description	Panel indication	External output status				
			○: There is continuity in the circuit. ×: There is no continuity in the circuit. –: The status immediately before alarm activation is retained.				
			Individual alarm output			Integrated alarm output	
			Relay output		Alarm/ Warning	Relay output	
A contact	B contact	A contact	B contact				
Power OFF		–	×	○	×	×	○
Power ON: Normal		Actual pressure display	○	×	○	○	×
[1]	Output device error	E10	–	–	×	×	○
	Instantaneous overcurrent	E11	–	–	×	×	○
	Overspeed	E12	–	–	×	×	○
	Regenerative brake overload	E14	–	–	×	×	○
	Undervoltage	E15	–	–	×	×	○
	Overvoltage	E16	–	–	×	×	○
	Electronic thermal	E17	–	–	×	×	○
	Magnetic pole detection error	E18	–	–	×	×	○
	Encoder cable break	E20	–	–	×	×	○
	Motor cable break	E21	–	–	×	×	○
	Power supply open phase	E24	–	–	×	×	○
	Pressure sensor error	E30	–	–	×	×	○
	Motor start error	E31	–	–	×	×	○
	Motor thermistor cable break	E40	–	–	×	×	○
	Motor temperature abnormal rise	E41	–	–	×	×	○
	Radiator fin thermistor cable break	E42	–	–	×	×	○
	Fin temperature abnormal rise	E43	–	–	×	×	○
Drying operation error	E64	–	–	×	×	○	
CPU runaway (watchdog)	E91	–	–	×	×	○	
[2]	EEPROM data error (1)	E93	×	○	×	×	○
	EEPROM data error (2)	E94	×	○	×	×	○
[3]	Motor temperature abnormal warning	L44	○	×	×	×	○
	Fin temperature abnormal warning	L45	○	×	×	×	○
	Power supply voltage drop warning	L50	○	×	×	×	○
	Pressure deviation abnormal warning	L60	○	×	×	×	○
[4]	Pressure switch activation ^{Note 1}	L63	×	○	○	×	○

During activation of an alarm of Classification [1], the system records the alarm, and holds the alarm code on the display. During activation of an alarm of Classification [1], the pressure switch does not work. The system retains the status immediately before activation of the alarm.

When alarm output combination setting [P08] is “1” (integrated alarm output is selected), the alarm signal is output even if the warning/pressure switch is activated.

Note 1 The pressure switch activation alarm code (“L63” of Classification [4]) is displayed only with the a) or b) setting below:

a) When the pressure switch display hold setting (Setting mode [P03]) is “1” or “2”.

b) When the pressure switch setting [P01] is enabled (When any number other than “0” is entered)

When the pressure switch display hold setting [P03] is “1” or “2”, the display hold status cannot be reset until the  key is pressed.

When the pressure switch display hold setting [P03] is “2”, the alarm is stored in the alarm record if the pressure falls below the value of the pressure switch setting [P01].

* The alarm/warning output of the individual alarm output of Classification [3], and the relay output B contact of the integrated alarm output vary depending on the warning output level setting [P07].

See “Attachment: Power-ON External I/O Signal Timing Chart”.

[12. Maintenance]

To keep the motor pump performance in good conditions for a long period, conduct periodic maintenance on the following items. If there is a problem, repair or replace defective parts.

Standard inspection cycles are listed below. However, these cycles considerably vary depending on the operating conditions and environment.

■ Periodic inspection

Item	Inspection cycle	Method
<ul style="list-style-type: none"> ● Oil tank <ul style="list-style-type: none"> • Oil level check • Oil temperature check • Oil color check 	Daily, Occasionally Daily, Occasionally Semiannually	Make sure that the float of the oil level gauge is between the red and yellow lines. Check the hydraulic oil for whitish muddiness and air bubbles. Make sure that the oil temperature is 60°C or less. (Normally, use the oil at 15 to 50°C.) Deterioration of hydraulic oil can be checked by color. If the hydraulic oil turns brownish (ASTM L4 level: bright yellow), replace it.
<ul style="list-style-type: none"> ● Oil cooler <ul style="list-style-type: none"> • Fan motor rotation • Clogging of the core 	Daily, Occasionally Semiannually	Make sure that the fan motor is rotating. Visually check the core for clogging. If the fan motor rotation is stopped, or the core is clogged, <ul style="list-style-type: none"> [1] the oil cooler cooling capacity remarkably deteriorates. This causes the hydraulic oil or the unit to become hot, resulting in burns. Also, this accelerates deterioration of the hydraulic oil, causing the unit service life to be shortened. [2] the motor becomes hot, causing the motor service life to be shortened. [3] the controller heat radiation performance deteriorates, causing the electric component service life to be shortened. The fan motor serves to cool the motor and the controller, as well as hydraulic oil.
<ul style="list-style-type: none"> ● Pressure display <ul style="list-style-type: none"> • Operation check • Pressure display check 	Daily, Occasionally Daily, Occasionally	Check if the indicated value changes according to load condition changes. Make sure that the pressure display for D.H. conforms to the preset value.
<ul style="list-style-type: none"> ● Sound and vibration 	Daily, Occasionally	Check for abnormal sound and vibration.
<ul style="list-style-type: none"> ● Electric wiring 	Semiannually	<ul style="list-style-type: none"> [1] Check the cable sheathing for cracks or fracture. [2] Measure the insulation resistance, and check for a decrease in insulation resistance. [3] Make sure that the ground cable is securely connected.
<ul style="list-style-type: none"> ● Hose 	Yearly	Check the hose for cracks, fracture or flaws.
<ul style="list-style-type: none"> ● Screws and pipes 	Daily, Occasionally	Check screws and pipes for looseness and oil leak.

■ Cleaning and replacement

Item	Operation cycle	Method
<ul style="list-style-type: none"> ● Replacement of oil tank and oil <ul style="list-style-type: none"> • Oil replacement 	Yearly	Replace hydraulic oil periodically. If the oil is used without replacement for a long period, it has bad influences on operation and service life of the hydraulic unit.
<ul style="list-style-type: none"> ● Cleaning of oil cooler and core 	Yearly	Disassemble and clean the oil cooler and the core according to “Maintenance Procedure” on p. 37 and p. 38.
<ul style="list-style-type: none"> ● Oil filling port (Air breather) 	Yearly	Disassemble and clean the oil filling port (air breather) according to “Maintenance Procedure” on p. 39.
<ul style="list-style-type: none"> ● Suction strainer 	Yearly	Disassemble and clean the suction strainer according to “Maintenance Procedure” on p. 40.

▲ DANGER

- [1] Do not access or touch rotating parts.
- [2] If you touch internal components of the controller, observe the following procedure to prevent electric shock.
- i) Turn OFF the hydraulic unit main power supply.
(Turn OFF the power supply circuit breaker.)
To prevent erroneous operation during work, post an “Operation Prohibited (During Work)” sign on the power supply circuit breaker.
 - ii) Remove the controller cover after elapse of at least five minutes.
The controller uses a large-capacitance capacitor. If you work with the capacitor charged, you may get electric shock. Before removing the controller cover, be sure to leave the controller for **at least five minutes** to discharge electricity from the capacitor.
- [3] Before turning ON the power supply to start operation, mount all covers to the controller.

■ Oil cooler maintenance procedure

▲ WARNING

[1] Before maintenance work, stop operation, and turn OFF the main power supply.
 [2] During work, wear protective goggles and gloves.
 i) The core fin has a sharp edge. Be careful not to hurt yourself.
 ii) During air blow, be careful that foreign bodies will not touch your eyes.

▲ CAUTION

[1] Be careful that strong force will not be applied to the fan motor power supply cable and connector during work.
 [2] During disassembly process, oil will flow out of the pipes and oil cooler.

1. Dismounting the oil cooler

[1] Open the controller cover, and disconnect the fan connector and fan ground cable.

[2] Remove the hose bands (at two places), and disconnect the hoses (two pieces) at the top of the oil cooler.

Note) In this step, oil may leak due to backward oil flow from the tank.
 Before conducting this step, attach a blind plug to each hose.

[3] Remove the hexagon socket head bolts (M5 x L16: 2 pieces) with washers, and dismount the oil cooler.

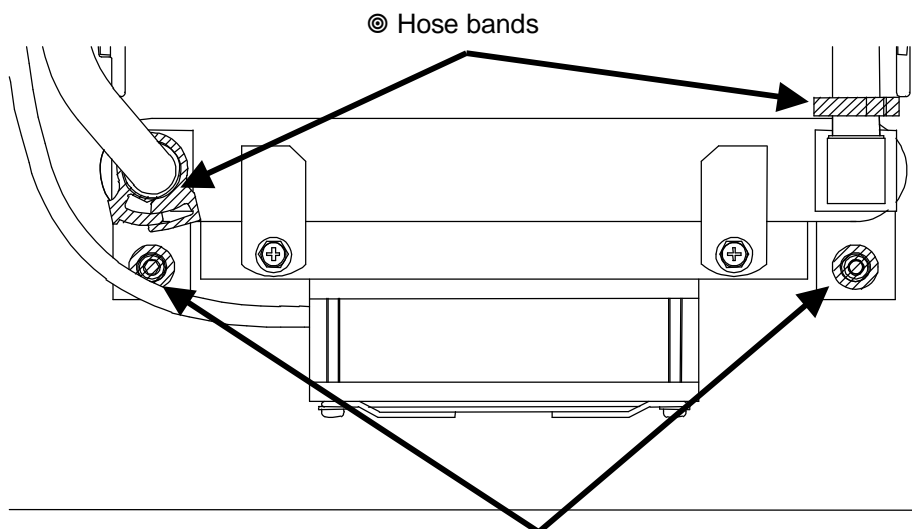
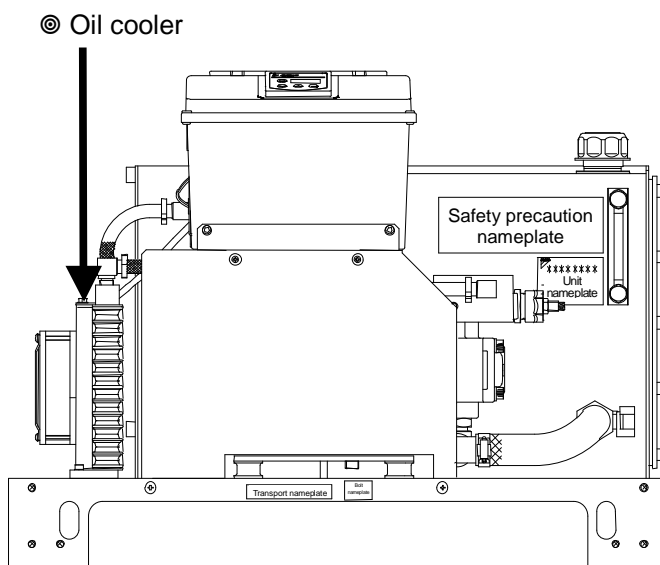

◎ Hexagon socket head bolts (M5 x L16: 2 pieces) with washers

<Unit top view>

2. Disassembling the oil cooler

- [1] Remove the cross recessed hexagon head bolts (M5 x L12: 3 pieces), and separate the shroud from the core.
- [2] Remove the cross recessed head machine screws (M4 x L70: 4 pieces), and separate the fan motor and finger guard from the shroud.

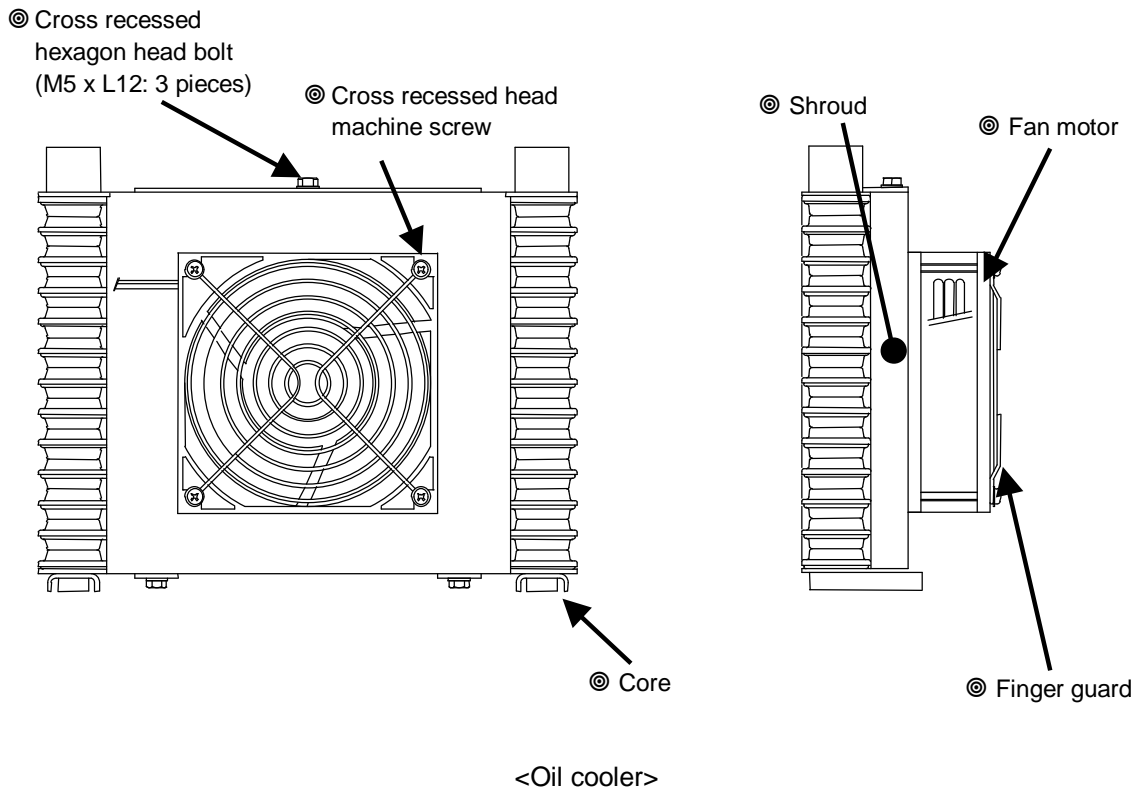

3. Cleaning the core

Blow air or steam onto the core, and clean the fins by blowing off dust accumulated on/adhering to the fins. When cleaning the fins, be careful that the dust blown away will not enter the core.

4. Cleaning the fan motor

Clean the clearance between the blade periphery and the casing, as well as the blades and the casing, by using a cloth.

▲ CAUTION

[1] Prohibition of steam/air blow

- Never attempt to blow steam or air onto the fan motor. Steam/air blow causes foreign bodies to be blown into the motor.

5. Reassembling the oil cooler

After cleaning is completed, reassemble the oil cooler.

After reassembling is completed, conduct the test run procedure described on p. 24 to make sure that the hydraulic unit normally operates.

Check if the oil cooler air intake/exhaust direction is correct. (See p. 13)

Oil filling port (air breather) maintenance procedure

1. Removing procedure
The cap can be easily removed by turning it counterclockwise by hand.
2. Cleaning procedure
Blow air onto the filter to blow off dust accumulated on/adhering to the filter.
Remove dust from inside of the strainer cylinder.

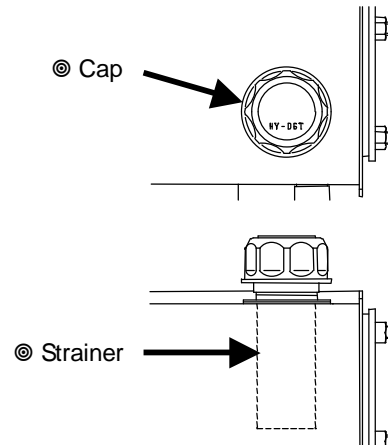

<Oil filling port (Air breather)>

3. Mounting direction
Mount the cap by turning it clockwise by hand until it stops.

▲ WARNING

- During air blow, wear protective goggles to prevent accumulated substances or dust from touching your eyes.

■ Suction strainer maintenance procedure

1. Removing procedure

- [1] After draining hydraulic oil completely, remove the nuts (M8: 12 pieces) from the cleaning door cover, and remove the cover from the cleaning door.
- [2] You can see the suction strainer. Loosen the strainer, and remove it.
(Hexagon nut, Width across flats: 41 mm)

2. Cleaning procedure

Blow air onto the filter to blow off dust accumulated on/adhering to the filter.
Remove dust from inside of the strainer cylinder.

3. Reassembling the strainer

After cleaning is completed, reassemble the suction strainer. Follow the removing procedure in reverse.

After reassembling is completed, conduct the test run procedure described on p. 24 to make sure that the hydraulic unit normally operates.

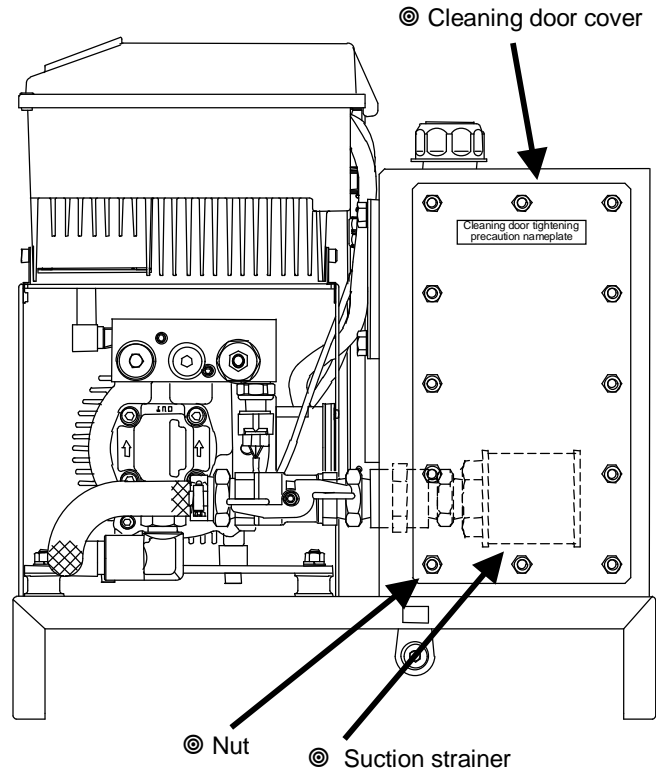

▲ WARNING

- During air blow, wear protective goggles to prevent accumulated substances or dust from touching your eyes.

[Attachment: Safety Valve Adjusting Procedure]

In any of the following three cases, adjust the safety valve with reference to “Safety Valve Adjusting Procedure”.

1. When safety valve setting adjustment is required:

Even if the hydraulic unit is used with the maximum pressure setting, the safety valve will not be activated under normal pressure control (except for the transient period when the circuit is blocked due to stop of the master machine hydraulic actuator). However, the safety valve set pressure will be lowered due to long-term repeated operations and contaminants in the hydraulic oil. If the safety valve is activated even with normal conditions, safety valve adjustment is required.

[Judgment criteria]

- The hydraulic oil temperature rising time is shorter than before.
 - When the safety valve adjusting screw is turned in the tightening direction, the rpm indication in the pressure hold status is lowered.
2. To minimize surge pressure that much exceeds a set pressure, safety valve adjustment is required in consideration of the withstand pressure of the hoses being used.
3. When the pressure set value is changed from the factory setting:
In order to suppress surge pressure to protect the master machine peripheral equipment (actuator, pressure gauge, etc.), it is recommended that the safety valve set pressure should be set “pressure of the unit + 0.5 MPa”.

<Safety valve adjusting procedure>

- [1] Referring to the enlarged view of the safety valve shown below, loosen the lock nut. (M10 lock nut, Width across flats: 14 mm)
- [2] According to the pressure adjusting screw length reference chart, determine the screw length corresponding to a desired control pressure setting. (The tip of the adjusting screw is 7 mm in width. It has four chamfered planes.)
- [3] Turn ON the hydraulic unit power supply, and select the setting mode through panel key operation. Then, set a desired pressure.
- [4] Select [n05] (rpm display) in the monitor mode through panel key operation to show the current rpm.
- [5] Adjust the pressure adjusting screw length in the longitudinal direction, and find an activation starting point as shown on the right.
- [6] Turn the pressure adjusting screw by 3/4 turn from the activation starting point to tighten the screw.
- [7] Tighten the lock nut. This completes the safety valve adjusting procedure.
(When tightening the lock nut, be careful not to allow the adjusting screw to turn.)

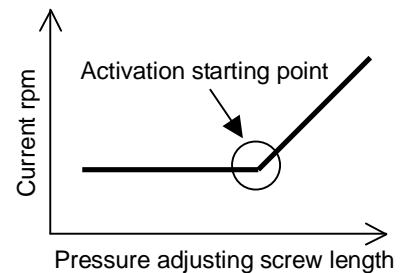

Pressure adjusting screw length

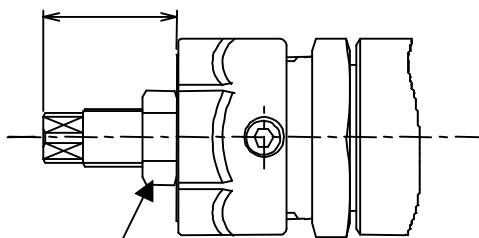

<Detailed view of safety valve>

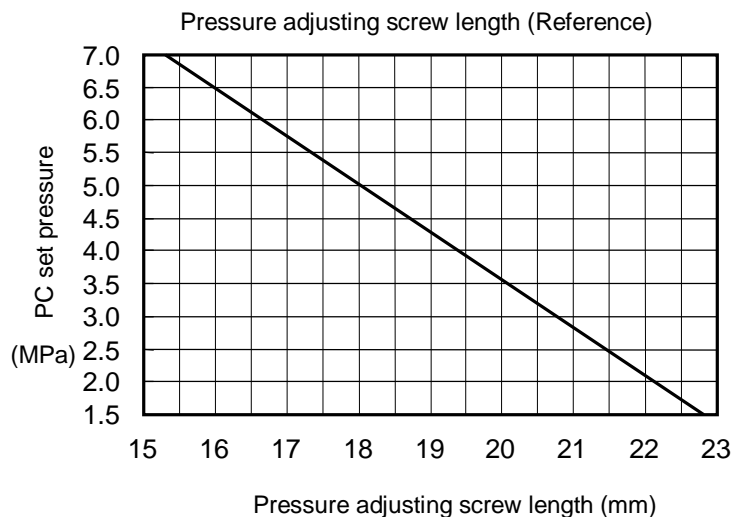

[Attachment: Power-ON External I/O Signal Timing Chart]

1. When parameter [P08] is "0"

1-1 When the pressure switch function is not used

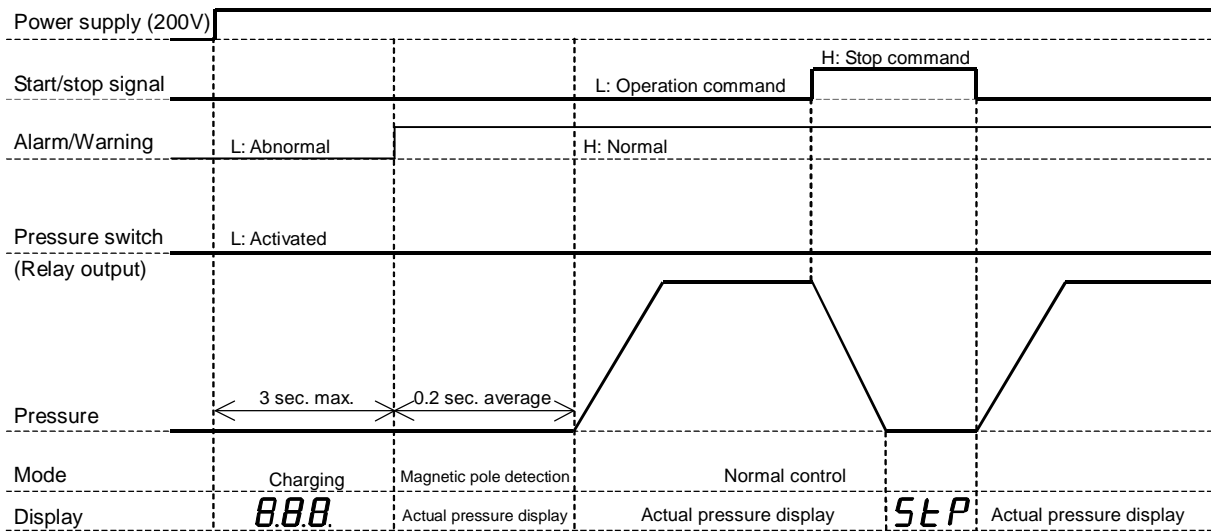

1-2 When the pressure switch function is used

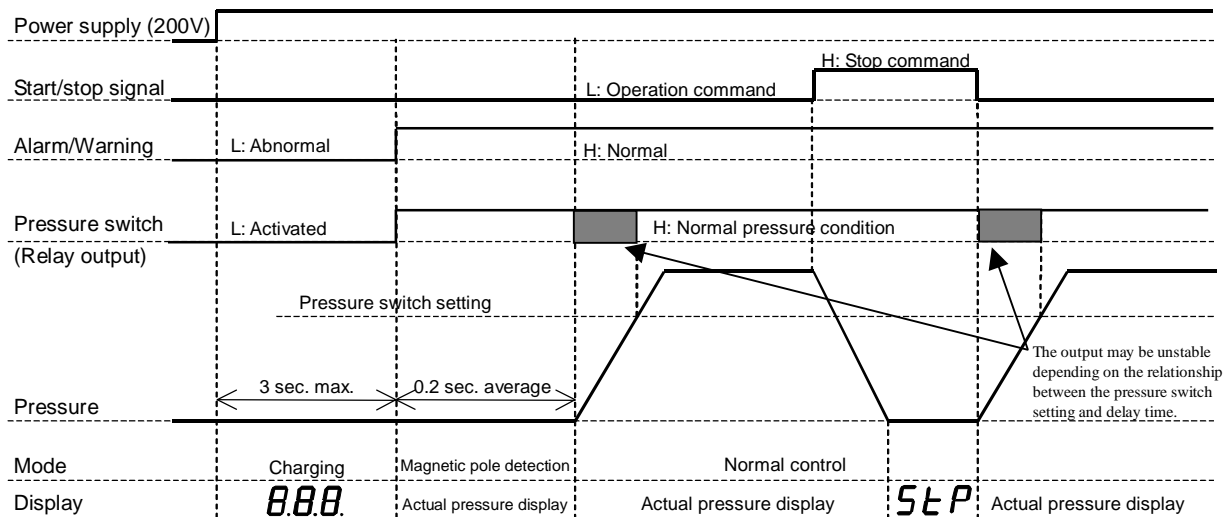

1-3 When the pressure switch function is used (Stop at power-ON)

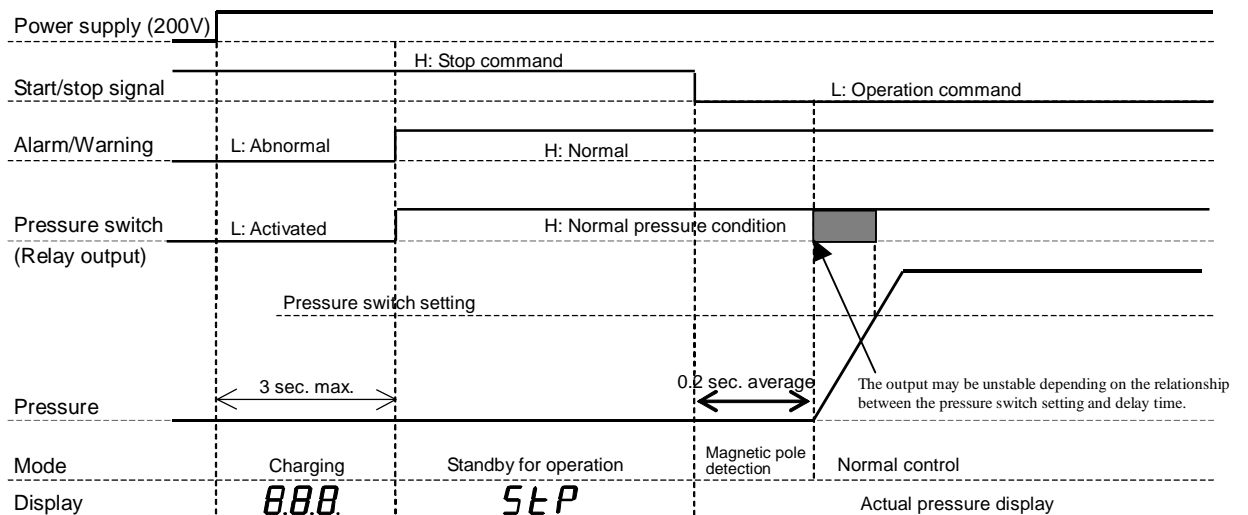

* Magnetic pole detection will be executed at the first motor startup after power-ON.

1-4 Alarm classification [1]

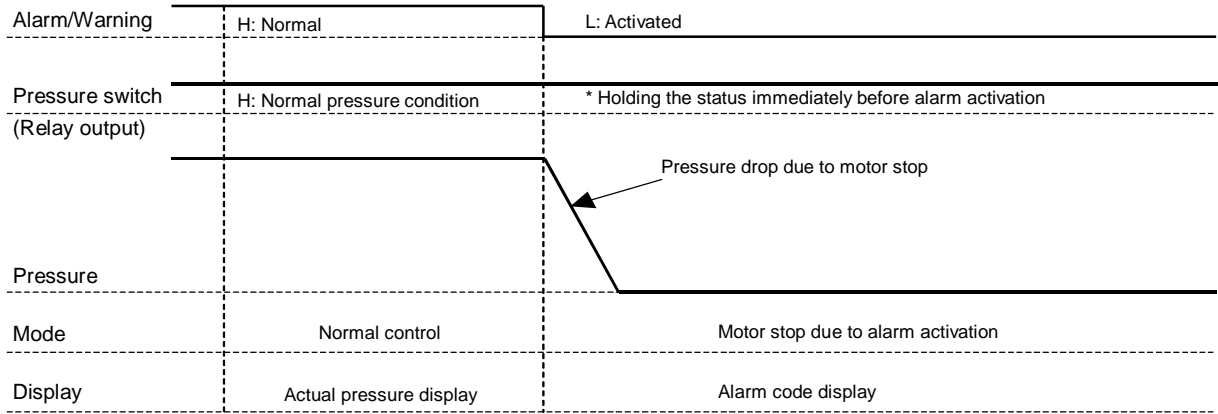

1-5 Alarm classification [2]

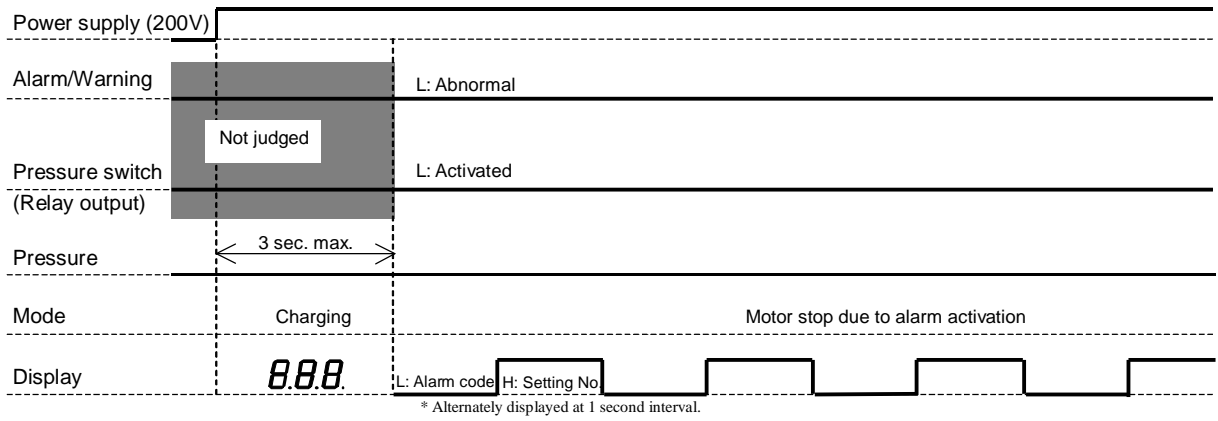

1-6 Alarm classification [3]

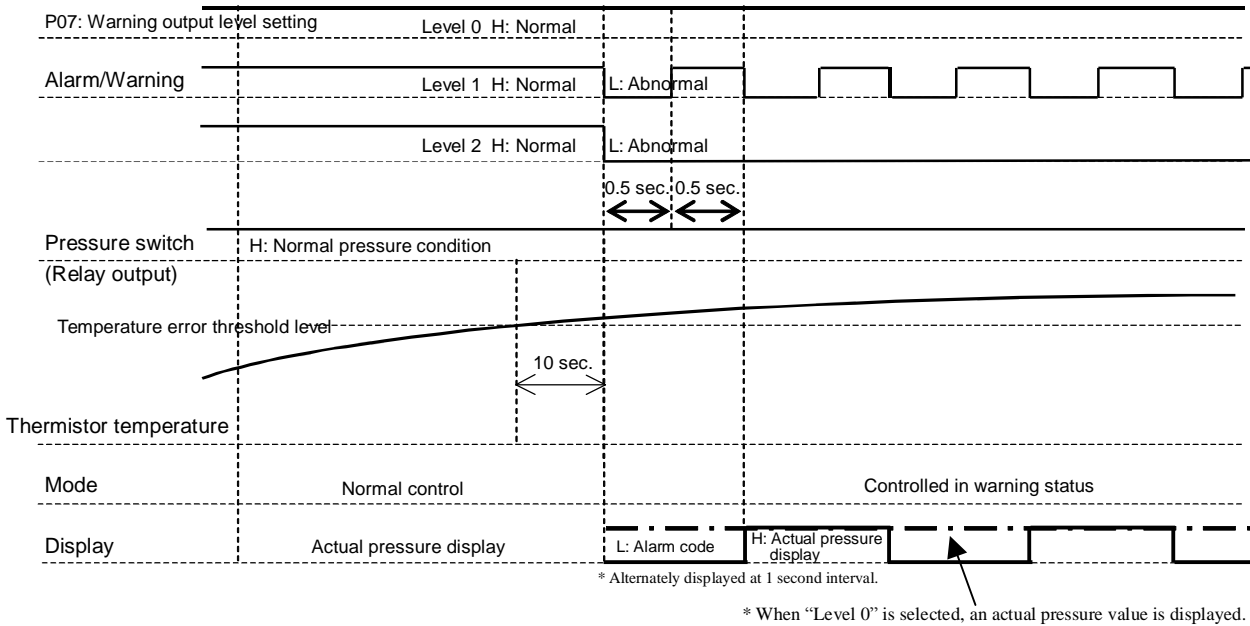

1-7 Alarm classification [4]

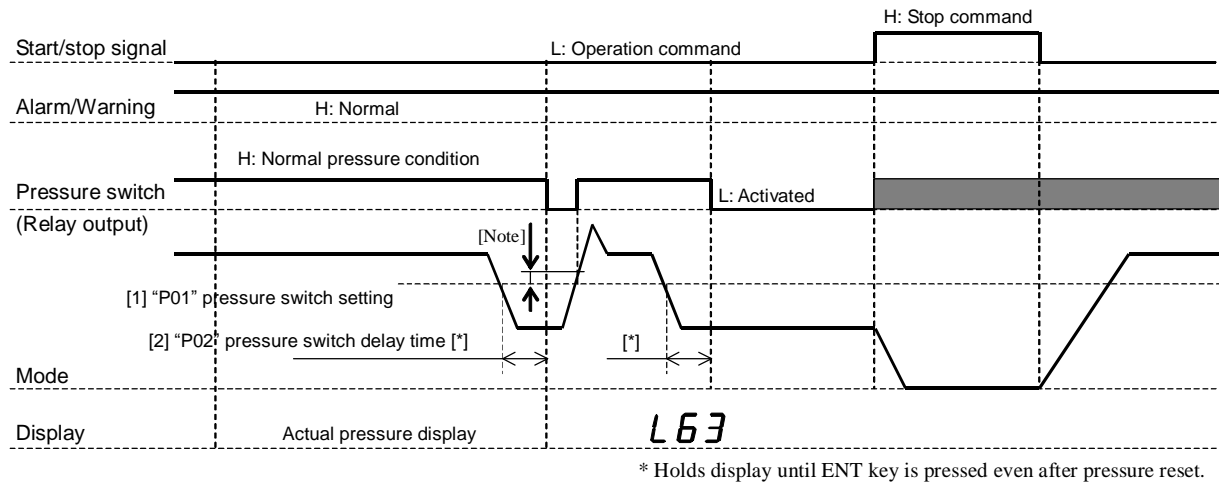

The above chart shows the case where "P03" (Pressure switch display hold setting) is [1] or [2].

When "P03" is [0], an actual pressure value is displayed.

When the stop command is activated by the start/stop signal, the pressure switch is in the normal condition.

The "P01" and "P02" settings (above [1] and [2]) can be changed in the setting mode.

For the setting procedure and setting range, see "Operating procedure for each mode: b) Setting mode" on p. 26.

Note) For the purpose of explanation, the above "1-7 Alarm classification [4]" chart shows the case where the pressure switch is activated without a dead zone.

Actually, however, the pressure switch has a dead zone of approx. 0.5 MPa.

2. When parameter [P08] is "1"

2-1 When the pressure switch function is not used

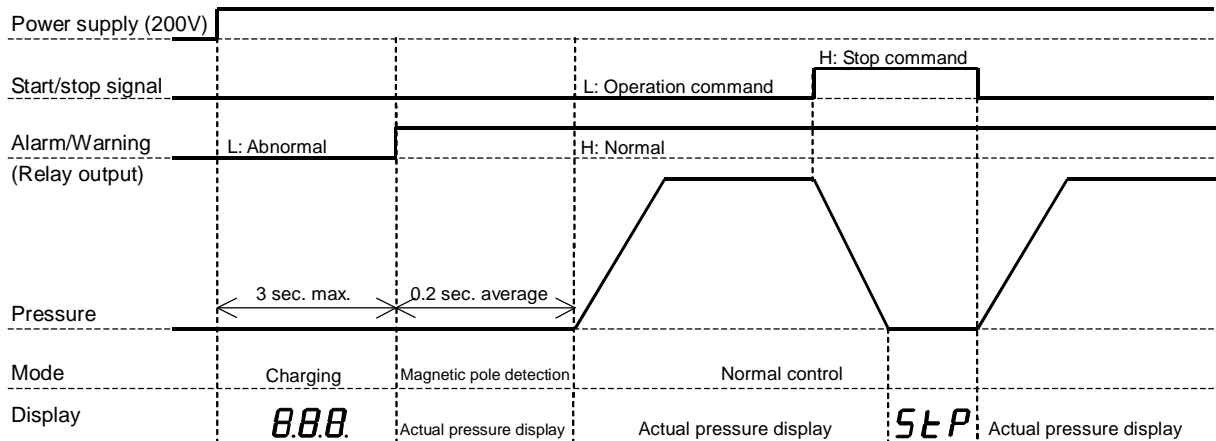

2-2 When the pressure switch function is used

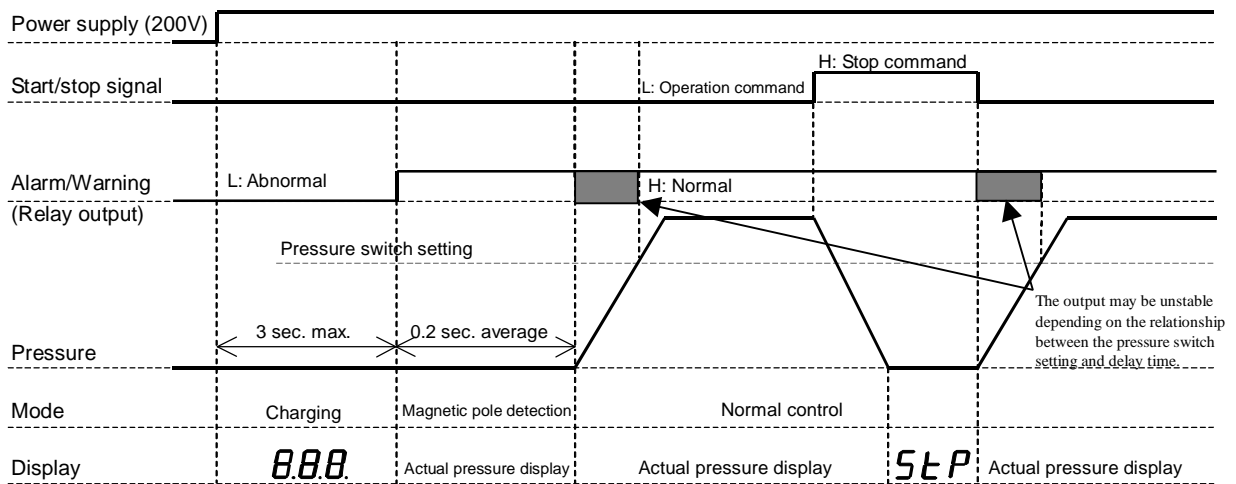

2-3 When the pressure switch function is used (Stop at power-ON)

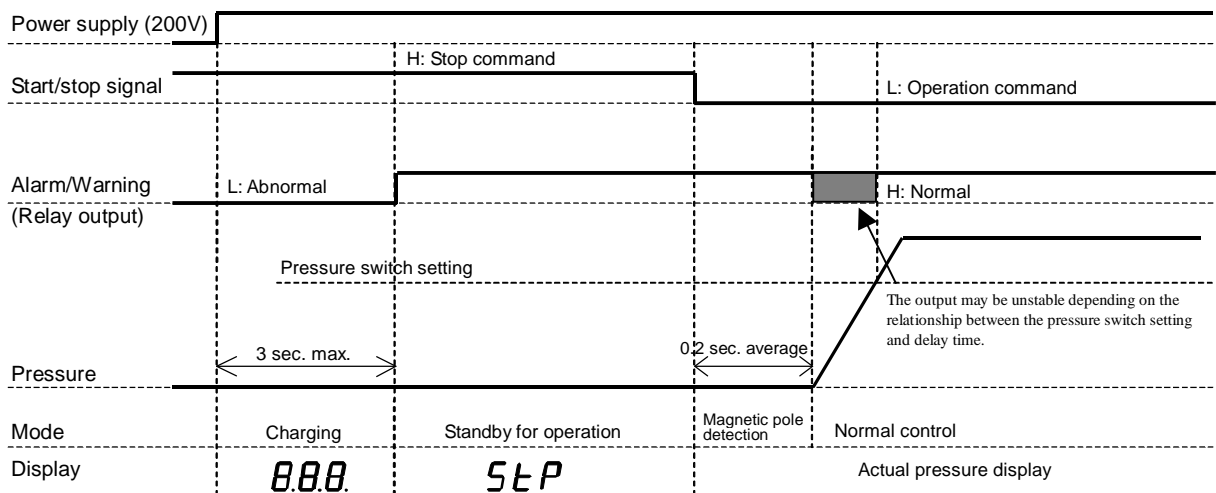

* Magnetic pole detection will be executed at the first motor startup after power-ON.

2-4 Alarm classification [1]

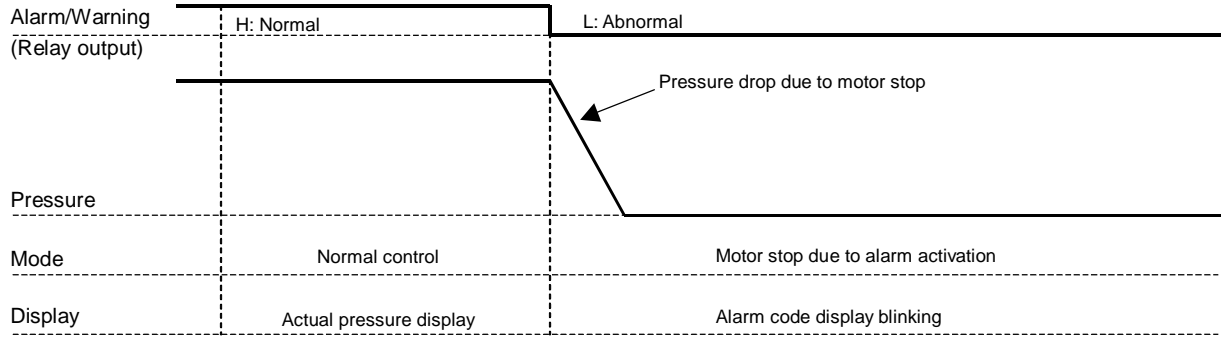

2-5 Alarm classification [2]

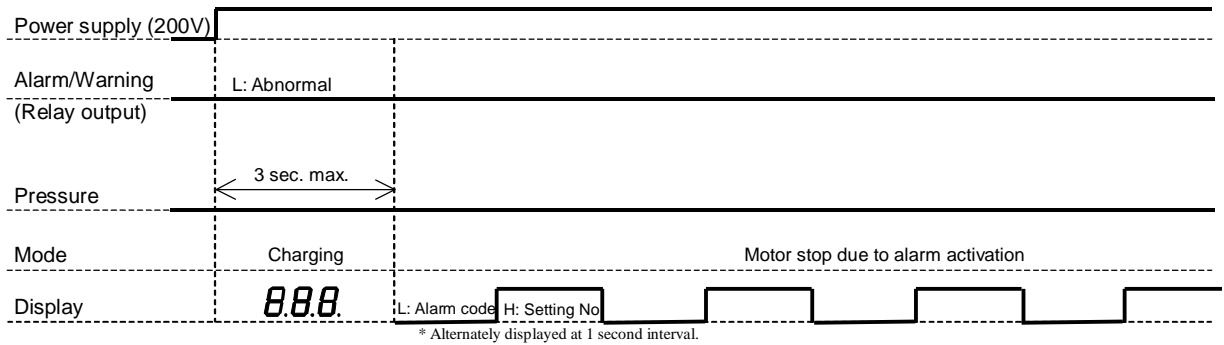

2-6 Alarm classification [3]

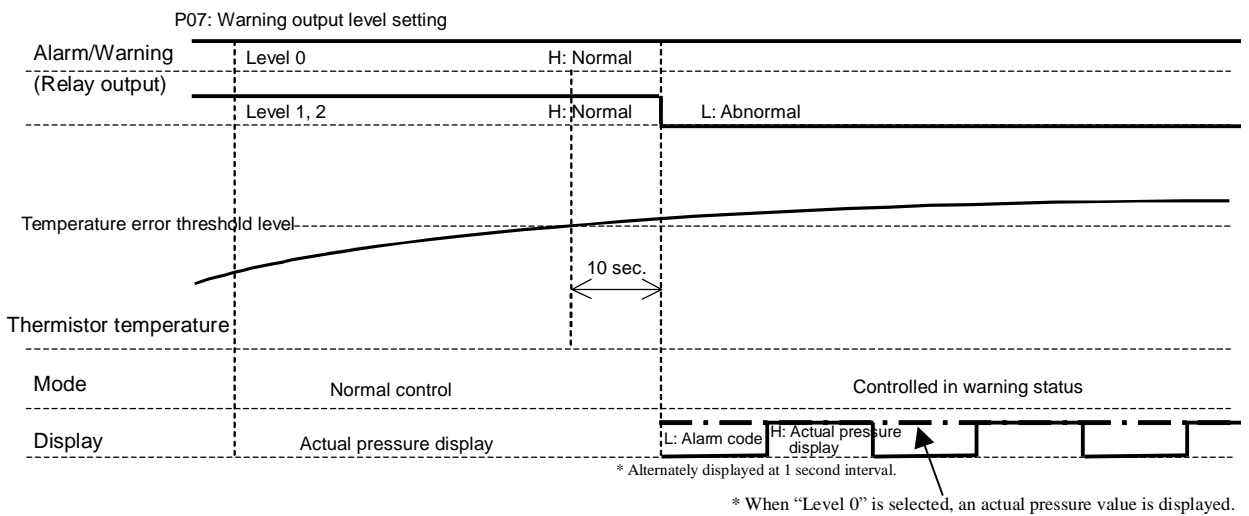

2-7 Alarm classification [4]

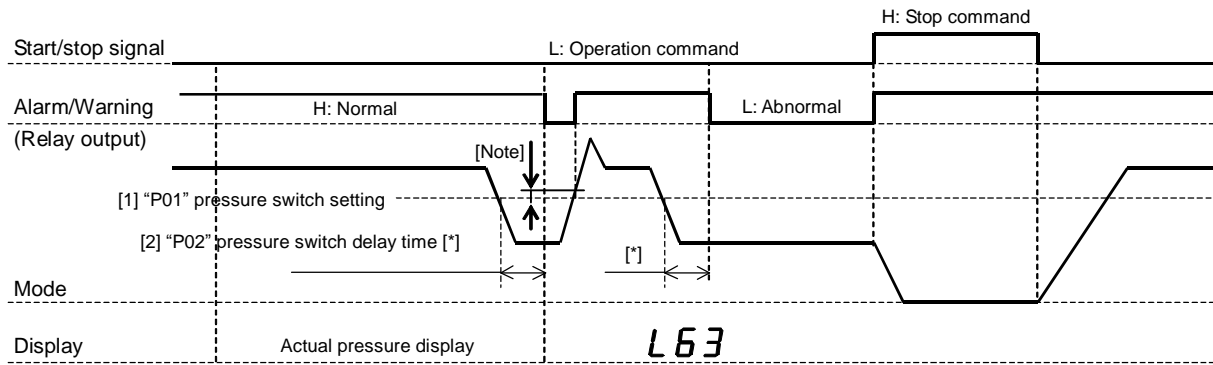

The above chart shows the case where “P03” (Pressure switch display hold setting) is [1] or [2].

When “P03” is [0], an actual pressure value is displayed.

When the stop command is activated by the start/stop signal, the pressure switch is in the normal condition.

The “P01” and “P02” settings (above [1] and [2]) can be changed in the setting mode.

For the setting procedure and setting range, see “Operating procedure for each mode: b) Setting mode” on p. 26.

Note) For the purpose of explanation, the above “2-7 Alarm classification [4]” chart shows the case where the pressure switch is activated without a dead zone.

Actually, however, the pressure switch has a dead zone of approx. 0.5 MPa.

3. Contact I/O timing chart

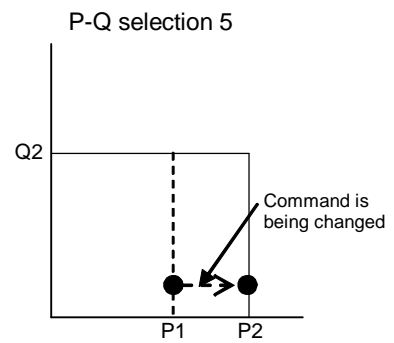
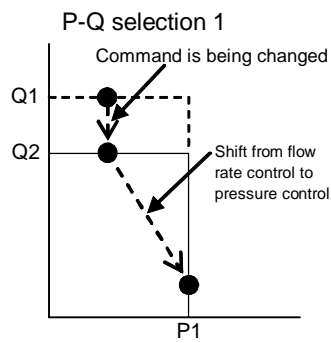
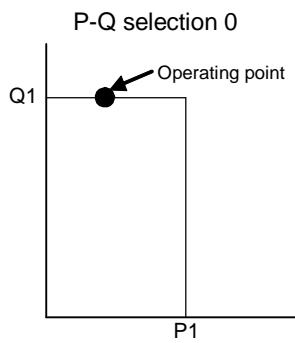
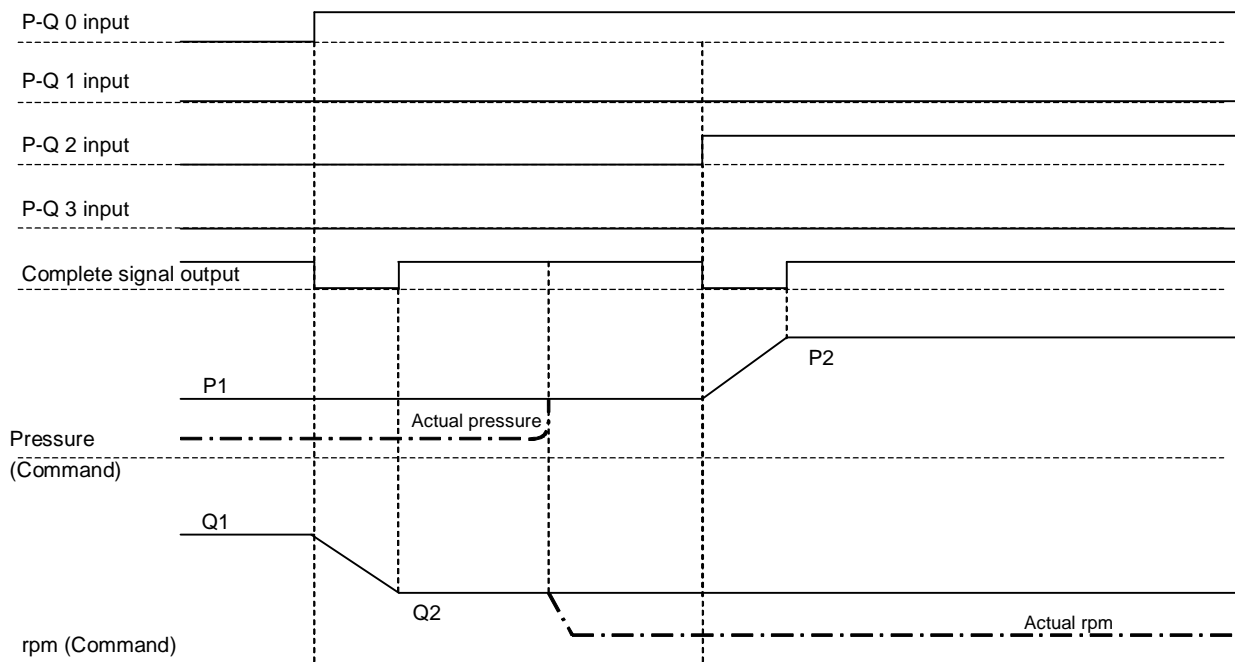

- When the command value is being changed according to a change in P-Q selection No., the complete signal status is “Lo”. When the command value does not change any more, the complete signal status is changed to “Hi”.