

Hybrid Systems

Inverter-controlled Hydraulic Power Units and Fluid Chillers



Industrial Solutions by Daikin



ECORICH



ECORICH-R



SUPER UNIT



Fluid cooling unit

Table of contents

Environmental contribution	4
Environmental Vision 2050.....	4
Sustainable Development Goals	5
Core technology	6
High-efficiency IPM motors	8
Hybrid hydraulic systems	10
Main features.....	12
The full hybrid hydraulic systems range	14
ECORICH.....	18
ECORICH-R.....	19
SUPER UNIT	20
SUPER UNIT - Double pump.....	21
SUPER UNIT - High-accuracy type	22
Case studies	23
Fluid cooling units	24
Main features.....	26
The full cooling unit range	28
AKZ	30
AKJ	32
AKJ W	33
AKC	34
AKW	35
Hybrid-Win	36
Application.....	37
Communication functions	38
Helping factories get ahead with IoT.....	40
Overview of communication functions	41

Environmental Vision 2050

Environmental Vision 2050 is our pledge to solve increasingly severe global environmental problems by reducing the CO₂ emissions - caused by our business activities, products and services - to zero. To achieve this vision, every five years, we set new targets and measures under our Fusion strategic management plan.

Using the Internet of Things (IoT), Artificial Intelligence (AI) and open solutions, we will

meet the world's needs for air solutions that provide safe and healthy environments, while contributing to solving global environmental problems.

Our oil hydraulic equipment supports Environmental Vision 2050 by incorporating the best energy-saving technology to help factories reduce their power consumption and produce fewer emissions.

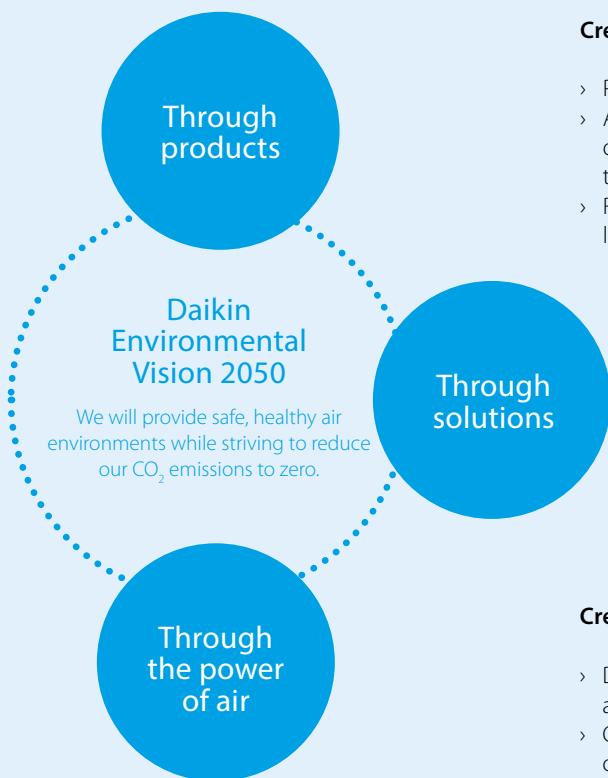

Creation of products and services with high environmental performance

- › Promotion of energy efficiency through inverters and other technologies.
- › Adoption of HFC-32 and other refrigerants with low global warming potential, development of next-generation refrigerants and promotion of heat pump technology.
- › Reduction of the environmental impact of materials throughout the entire lifecycle - from procurement to disposal and recycling.

Creation of environmental solutions

- › Use of energy management to achieve optimal operation through a system that integrates air conditioners, heat pumps, refrigeration appliances and their peripheral equipment, buildings, and renewable energy.
- › Supporting the recovery and recycling of refrigerants.

Creation of air value

- › Development of environments that protect people's health from air pollution.
- › Creation of added value by improving air quality, for example in office and home environments.

How Daikin aims to achieve zero CO₂ emissions

We aim to reduce CO₂ emissions to zero by recovering and recycling refrigerants while at the same time creating products and solutions that minimise CO₂ emissions.

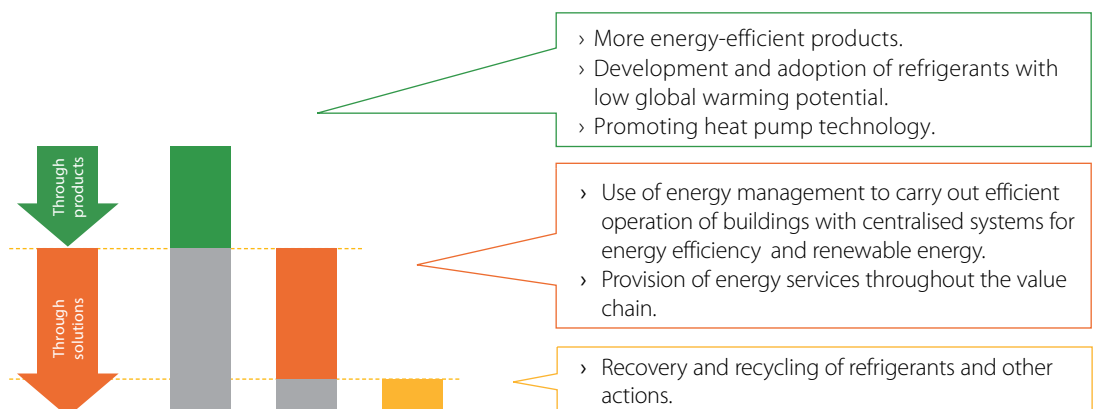

Sustainable Development Goals

as a guideline for value creation

The Sustainable Development Goals or SDGs, defined by the United Nations in 2015, are a set of 17 goals that aim to contribute to global sustainable development and tackle broad topics such as poverty, health, education, energy, global warming and gender equality. The target goal to achieve these goals is 2030.

Daikin is contributing to this initiative by creating value for the comfort and health of

people, the cities they live, the places they work and the environment they depend on.



For more information on the Sustainable Development Goals, please visit: <https://www.un.org/>



How Daikin helps factories save energy

Did you know that most energy consumption comes from the machine line? The hydraulic unit and fluid cooling unit contribute to the most energy consumption, and attaining energy-saving starts with reducing the power of these two products. Daikin hydraulic products use the latest technology to optimise production while reducing power to protect the environment.

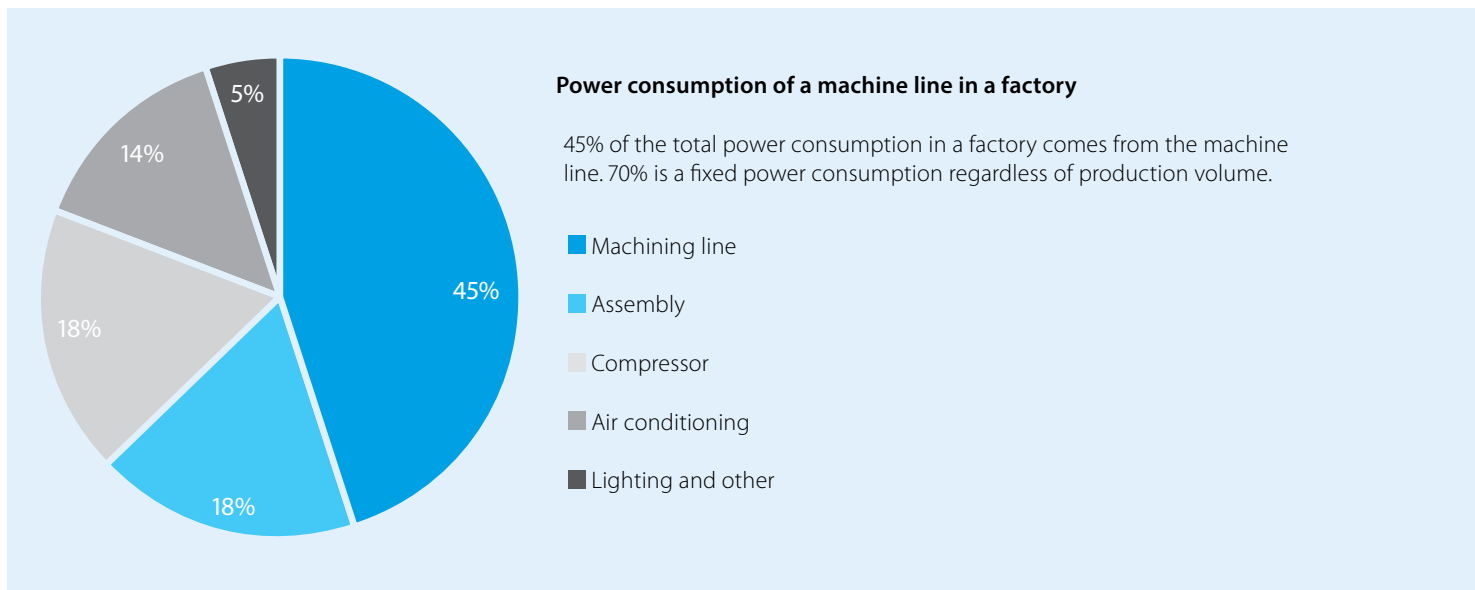

Daikin is a global leader in HVAC-R because we think differently about comfort and energy savings. Discover how we've adapted our revolutionary air conditioner technology for oil hydraulic products to help factories reduce their power consumption and protect the environment.



Daikin R&D center "Technology Innovation Center"

Core technology

High-efficiency IPM motors 8



High-efficiency IPM motors

Daikin was the first in the industry to introduce an interior permanent magnet synchronous motor (IPM motor) into air conditioners for household use and was an early adopter of the technology for industrial-use air conditioners. The same technology that helped over millions Daikin installations achieve energy savings is now available for factory equipment.

Double torque for high energy savings

A Daikin IPM motor is superior because it uses a double rotational force produced by two types of torque: neodymium (magnet torque) and Daikin's original reluctance torque. The combination of these two forces increases power while using less electricity to deliver energy savings.

Ferrite magnet

Neodymium magnet



Powerful neodymium magnets are what gives Daikin IPM motors their energy-saving effect.

The fundamentals of IPM motors

A rare-earth permanent magnet deeply positioned in the rotor generates magnet torque (attraction/repulsion between coil and permanent magnet) and reluctance torque (coil attracts iron). This electromagnetic structure attains high torque for the highest possible efficiency.

Structure of a conventional AC servo motor

Surface permanent magnet (SPM) motor

The lengths of the magnetic field lines at the south and north poles are equivalent, which means there's no rotational force or reluctance force generated.

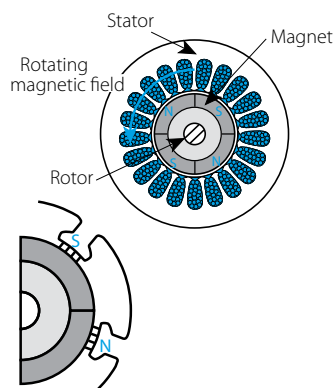

Structure of a Daikin IPM motor

IPM motor drive system

The magnetic field lines at the south pole side are longer than the north side. Similar to how a stretched rubber band contracts, the magnetic field lines at the south pole will try to shorten. As a result, a rotational force will occur due to the reluctance torque moving in a counterclockwise direction (see the arrow in the illustration).

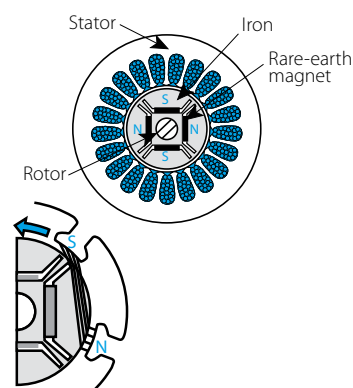

Comparing the results

Motor efficiency

The efficiency of a Daikin IPM is much higher than an induction motor, especially at low motor rotation speed.

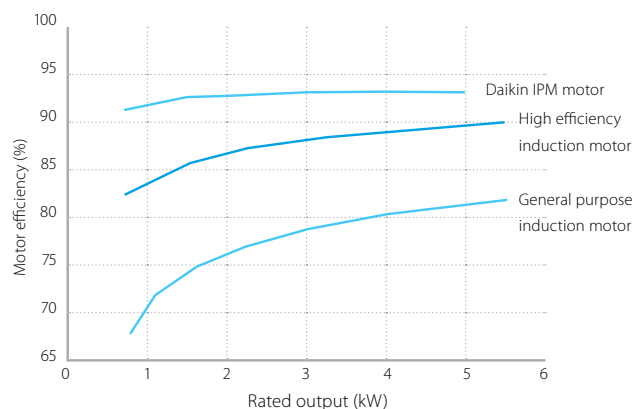

High torque at a low-speed range

Daikin IPM motors produce high torque at a low speed. Generally, an inverter type may have limited torque when set at a low-speed range, but Daikin IPM motors can work around this technicality.

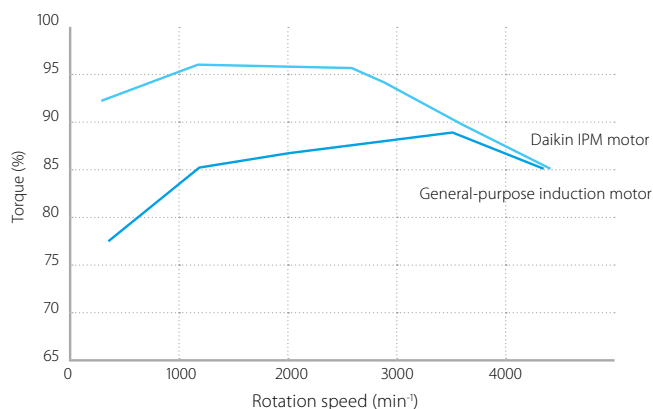



Daikin hybrid hydraulic systems offer a diverse range of functions and capacities to meet the needs of every machine type. Together, these products offer reduced heat generation, low operational noise and superior energy savings for factories.

Hybrid hydraulic systems

Main features.....	12
The full hybrid hydraulic systems range	14
ECORICH.....	18
ECORICH-R.....	19
SUPER UNIT	20
SUPER UNIT - Double pump.....	21
SUPER UNIT - High-accuracy type	22
Case studies	23

Main features

Multi-stage pressure/flow rate control

This function is a standard feature for Daikin hydraulic systems (Ecorich-R & Super Unit series). It allows a user to control the pressure and flow rate through different settings, eliminating the proportional control valve and proportional pressure control valve used in conventional systems.

How it works

After setting up the pressure flow rate using the controller's operation panel, a user can choose from **8 to 16 different pressure (P) and flow rate (Q) settings** to control the actuator.

The SUPER UNIT autonomously changes the control mode from flow rate control to pressure control. The solenoid valve that actuates the cylinder must be turned on/off at the machine. After registering the

acceleration and deceleration parameters, this feature ensures a shockless transition between the change in pressure and flow rate settings.

Example of PQ control settings

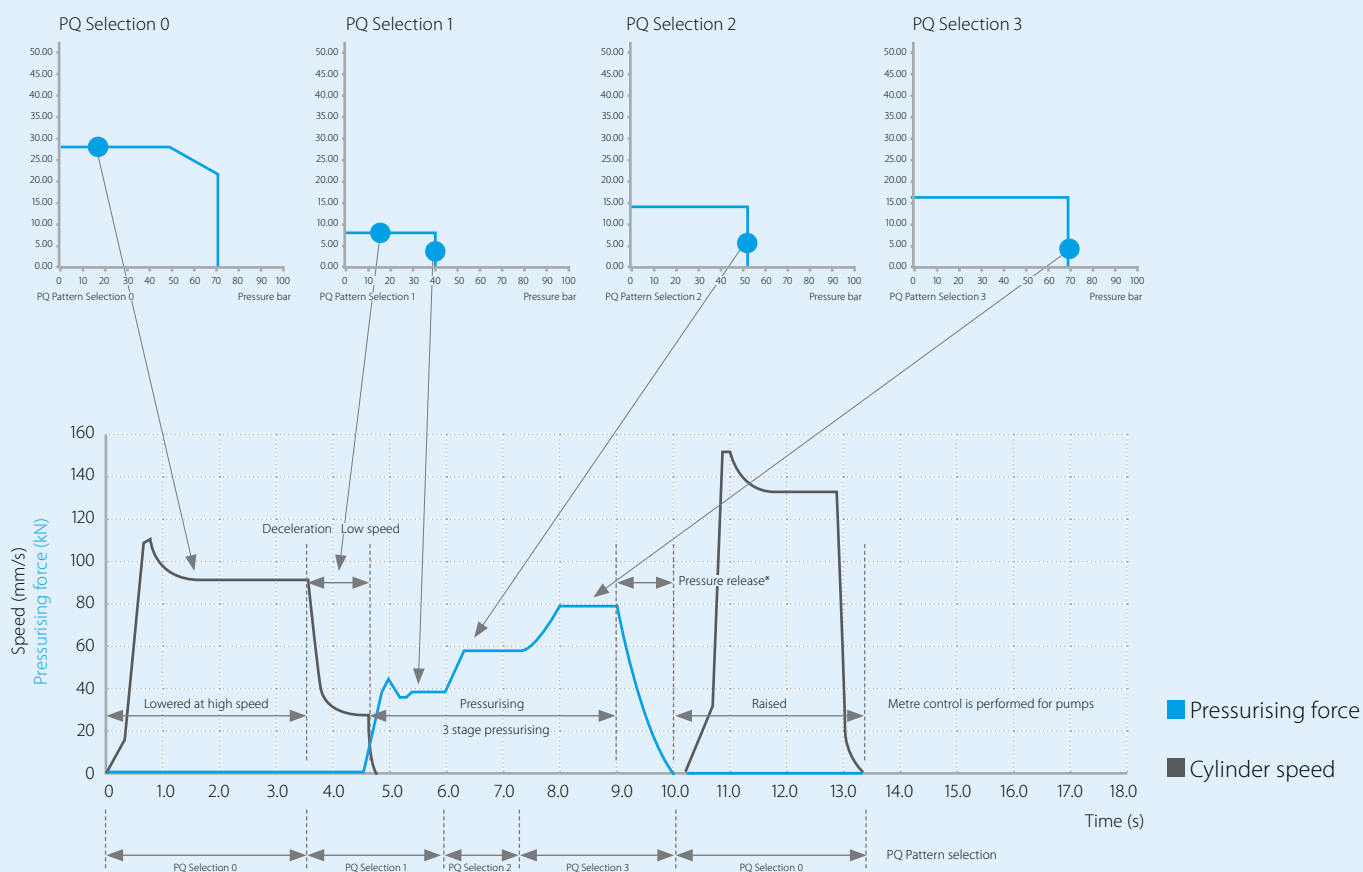

* When pressure release control is disabled, an additional pressure release circuit should be provided for the load side.

Low heat generator

Daikin hydraulic systems can dramatically reduce the amount of heat they generate to reduce air conditioning load and achieve more energy savings.

The advantages of low heat generation

- › Prevents oil temperatures from rising and deteriorating.
- › Reduces the oil tank size to save factory space.
- › Eliminates the need for an oil cooler in the unit.
- › Suppresses the load of the air conditioner for more energy savings.

Why restricting oil temperature is beneficial

SUPER UNITS that generate less heat also prevent hydraulic fluid temperatures from rising, which offers the following advantages:

- › Reduced thermal distribution for machine accuracy.
- › Reduced heat load on the air conditioner for more energy savings.
- › Extended service life of packing and sealing materials.
- › Prevents hydraulic fluid from deteriorating for longer service life.

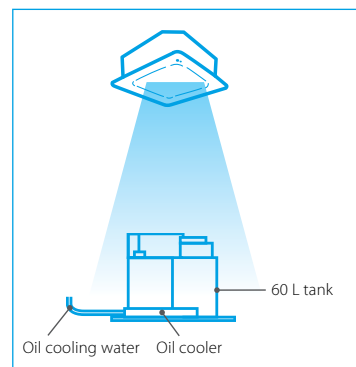

Large load
for an air conditioner

Adding low heat function
to a SUPER UNIT

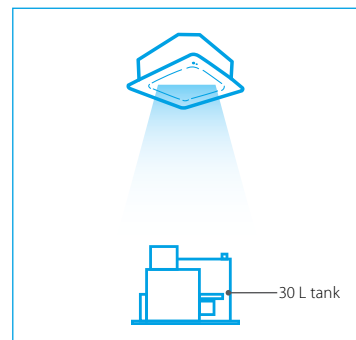

Small load
for an air conditioner

Low operating noise

The operational noise of a SUPER UNIT can go as low as 60 dB(A) (when the pressure is at 206 bar), and as low as 70 dB(A) in the full flow area.

Running the motor at the lowest optimum speed under a pressure-retained condition ensures the system achieves extremely low operational noise. The phase-differential tandem pump attains low pulsation and low noise (double-pump specification).

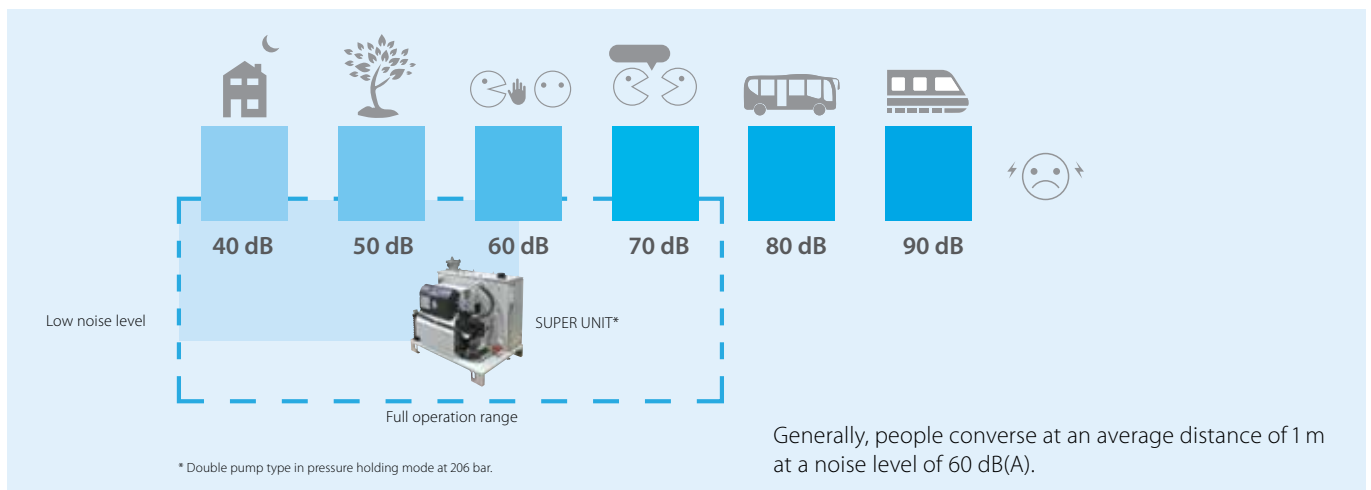

The full hybrid hydraulic systems range

The Daikin hybrid hydraulic systems range features the EHU, EHU-R and SUT. Each of these models offers a diverse range of functions and capacities to meet the needs of every machine type, create a comfortable work environment for employees and achieve excellent energy savings for factories.

Product name	Product picture	Tank capacity (L)	Nominal motor capacity (kW) Equivalent	Power supply voltage (V)	Pump type		
ECORICH		18	0.8	AC3~ 200 V	-		
			1.5				
			2.2				
			2.8				
ECORICH-R		Without Tank	2.2	AC3~ 200 V	-		
		18	2.8				
			2.2				
		33	2.8				
			2.2				
		SUPER UNIT				30	3.7
60	5.0						
100	7.0						
30	3.7						
30	3.7						
60	5.0						
	60		3.7	AC3~ 200 V	Double pump type		
	60		5.0				
	100		5.0				
	100		7.0				
	160		7.0				
	200		11.0				
SUPER UNIT			Without Tank	3.7	AC3~ 200 V	Single pump type	
				5.0			
		7.0					
		11.0					
		3.7					
		3.7		AC3~ 200 V		Double pump type	
		5.0					
		7.0					
		11.0					
		11.0					

Flow rate selection	Maximum operating pressure (bar)	Maximum flow rate (L / min)	Digital input			Analogue input	Model code
			1PQ	8PQ	16PQ		
-	40	15.2	✓	-	-	-	EHU1404-40
		25.1					EHU2504-40
	70	25.1					EHU2507-40
		28.5					EHU3007-40
-	70	28.5	✓	-	-	-	EHU3007-40-Y
-	70	15.2	-	-	✓ (option)	-	EHU15R0700-40-03
	100						EHU15R1000-40-03
	70	28.5					EHU30R0700-40-03
		100					15.2
	70						28.5
		100					15.2
	70						28.5
	100	15.2					EHU15R1003-40-03
70	28.5	EHU30R0703-40-03					
-	70	39.7	-	-	✓ (option)	-	SUT03S4007-30
	70	61.1					SUT06S6007-30
	70	83.0					SUT10S8007-30
	100	25.6					SUT03S3010-30
	160	15.2					SUT03S1516-30
		25.6					SUT06S3016-30
Combination	70	41.0	-	-	✓	-	SUT06D4016-30
Independent	157	16.0	-	-	✓	-	SUT06D6021-30
Combination	70	61.1	-	-	✓	-	SUT06D6021-30
Independent	206	21.1	-	-	✓	-	SUT10D6021-30
Combination	70	61.1	-	-	✓	-	SUT10D6021-30
Independent	206	21.1	-	-	✓	-	SUT10D6021-30
Combination	70	83.0	-	-	✓	-	SUT10D8021-30
Independent	206	28.7	-	-	✓	-	SUT10D8021-30
Combination	70	83.0	-	-	✓	-	SUT16D8021-30
Independent	206	28.7	-	-	✓	-	SUT16D8021-30
Combination	70	110.0	-	-	✓	-	P-SUT20D11KW-40
Independent	206	40.5	-	-	✓	-	P-SUT20D11KW-40
-	70	39.7	-	-	✓ (option)	-	SUT00S4007-30
	70	61.1					SUT00S6007-30
	70	83.0					SUT05S8007-30
	70	110.0					SUT05S11007-30
	100	25.6					SUT00S3010-30
		160					15.2
	25.6						SUT00S3016-30
	Combination	70					41.0
Independent	157	16.0	-	-	✓	-	SUT00D6021-30
Combination	70	61.1	-	-	✓	-	SUT00D6021-30
Independent	206	21.1	-	-	✓	-	SUT00D6021-30
Combination	70	83.0	-	-	✓	-	SUT00D8021-30
Independent	206	28.7	-	-	✓	-	SUT00D8021-30
Combination	70	110.0	-	-	✓	-	SUT00D11021-40
Independent	206	40.5	-	-	✓	-	SUT00D11021-40

Hybrid hydraulic systems

Product name	Product picture	Tank capacity (L)	Nominal motor capacity (kW) Equivalent	Power supply voltage (V)	Pump type
SUPER UNIT (High-accuracy type)		Without Tank	7.0	AC3~ 200 V	Single pump type
			11.0		
			11.0		
			15.0		
			15.0		
			11.0		
			11.0	AC3~ 400 V	
			15.0		
			15.0		
			15.0		
			22.0		
			22.0		
			7.0	AC3~ 200 V	Double pump type
			11.0		
			15.0		
			15.0		
			15.0		
			22.0		
			37.0		
			37.0		
			37.0		
			37.0		
			37.0		
			37.0		
11.0	AC3~ 400 V				
15.0					
15.0					
15.0					
15.0					
11.0					
15.0					
22.0					
37.0					
37.0					
37.0					

Flow rate selection	Maximum operating pressure (bar)	Maximum flow rate (L / min)	Digital input			Analogue input	Model code
			1PQ	8PQ	16PQ		
-	176	30.0	-	✓ (parameter setting required)	-	✓	SUT00S3018-30-A
	206	50.0					SUT00S5021-40-A
	176	80.0					SUT00S8018-40-A
	245	50.0					SUT00S5025-41-L-N0432
	176	150.0					SUT00S15018-40-A
	206	50.0					SUT05S021-40YA-N0265
	176	80.0					SUT00S8018-40YA
	176	130.0					SUT00S13018-40YA-N0218
	206	130.0					SUT00S13021-40YA-N0286
	176	150.0					SUT00S15018-40YA
176	200.0	SUT00S20018-40YL-N0340					
Combination	176	30.0	-	✓ (parameter setting required)	-	✓	SUT00D3021-30-B-N0436
Independent	206	18.3	-	✓ (parameter setting required)	-	✓	SUT00D8021-40-B-N0323
Combination	176	80.0	-	✓ (parameter setting required)	-	✓	SUT00D8021-40-B-N0323
Independent	206	38.4	-	✓ (parameter setting required)	-	✓	SUT00D8021-40-B-N0323
Combination	206	130.0	-	✓ (parameter setting required)	-	✓	SUT0D13021-40-B-N0321
Independent	206	47.9	-	✓ (parameter setting required)	-	✓	SUT0D13021-40-B-N0321
Combination	176	150.0	-	✓ (parameter setting required)	-	✓	SUT00D15021-40-B-N0365
Independent	206	70.9	-	✓ (parameter setting required)	-	✓	SUT00D15021-40-B-N0365
Combination	110	200.0	-	✓ (parameter setting required)	-	✓	SUT00D20021-40-L
Independent	250	56.0	-	✓ (parameter setting required)	-	✓	SUT00D20021-40-L
Combination	123	200.0	-	✓ (parameter setting required)	-	✓	SUT00D20025-41-L
Independent	250	56.0	-	✓ (parameter setting required)	-	✓	SUT00D20025-41-L
Combination	140	220.0	-	✓ (parameter setting required)	-	✓	SUT0D22028-41-L
Independent	280	63.2	-	✓ (parameter setting required)	-	✓	SUT0D22028-41-L
Combination	110	260.0	-	✓ (parameter setting required)	-	✓	SUT00D26021-41-L
Independent	206	111.0	-	✓ (parameter setting required)	-	✓	SUT00D26021-41-L
Combination	100	300.0	-	✓ (parameter setting required)	-	✓	SUT00D30021-41-L
Independent	206	111.0	-	✓ (parameter setting required)	-	✓	SUT00D30021-41-L
Combination	90	300.0	-	✓ (parameter setting required)	-	✓	SUT00D30028-41-L
Independent	280	56.0	-	✓ (parameter setting required)	-	✓	SUT00D30028-41-L
Combination	176	80.0	-	✓ (parameter setting required)	-	✓	SUT00D8021-40YB-N0324
Independent	206	38.4	-	✓ (parameter setting required)	-	✓	SUT00D8021-40YB-N0324
Combination	206	130.0	-	✓ (parameter setting required)	-	✓	SUT00D13021-40YB-N0322
Independent	206	47.9	-	✓ (parameter setting required)	-	✓	SUT00D13021-40YB-N0322
Combination	176	150.0	-	✓ (parameter setting required)	-	✓	SUT00D15021-40YB-N0358
Independent	206	70.9	-	✓ (parameter setting required)	-	✓	SUT00D15021-40YB-N0358
Combination	115	200.0	-	✓ (parameter setting required)	-	✓	SUT00D20021-40YL
Independent	250	56.0	-	✓ (parameter setting required)	-	✓	SUT00D20021-40YL
Combination	150	80.0	-	✓ (parameter setting required)	-	✓	SUT00D8025-40YL
Independent	250	40.0	-	✓ (parameter setting required)	-	✓	SUT00D8025-40YL
Combination	150	130.0	-	✓ (parameter setting required)	-	✓	SUT00D13025-40YL
Independent	250	37.3	-	✓ (parameter setting required)	-	✓	SUT00D13025-40YL
Combination	165	200.0	-	✓ (parameter setting required)	-	✓	SUT00D20025-40YL
Independent	250	56.0	-	✓ (parameter setting required)	-	✓	SUT00D20025-40YL
Combination	140	220.0	-	✓ (parameter setting required)	-	✓	SU00D22028-41YL
Independent	280	63.2	-	✓ (parameter setting required)	-	✓	SU00D22028-41YL
Combination	110	260.0	-	✓ (parameter setting required)	-	✓	SUT00D26021-41YL
Independent	206	111.0	-	✓ (parameter setting required)	-	✓	SUT00D26021-41YL
Combination	100	300.0	-	✓ (parameter setting required)	-	✓	SUT00D30021-41YL
Independent	206	111.0	-	✓ (parameter setting required)	-	✓	SUT00D30021-41YL
Combination	90	300.0	-	✓ (parameter setting required)	-	✓	SUT00D30028-41YL
Independent	280	56	-	✓ (parameter setting required)	-	✓	SUT00D30028-41YL

ECORICH

The world's first hybrid hydraulic system that combines hydraulics technology and Daikin motor/inverter technology.

- › Power consumption
The highly efficient IPM motor surpasses IE4 class to reduce power consumption by an additional 65% compared to a conventional hydraulic unit.
- › Oil temperature
Suppressing the oil temperature reduces the thermal influence on the machine, improves the environment at the machine site, prevents degradation of hydraulic oil and extends the oil replacement interval.
- › Space-saving design
A more compact and lightweight unit offers easier installation. All models offer a 9% reduced footprint. The EHU1404/2504 model offers a 40% mass reduction.
- › Complies with regulations
All models meet CE standards.



Excluded from high-efficiency motor regulations

Figures compared to conventional ECORICH design 30 series models.



Hybrid-Win

is a PC utility software that reads the data from Daikin hybrid hydraulic units, including the ECORICH, SUPER UNIT and Fluid cooling unit. It sends the data to a Windows application where users can set parameters and monitor units.

For more information about Hybrid-Win, please go to page 38.

Model code		EHU1404-40	EHU2504-40	EHU2507-40	EHU3007-40	EHU3007-40-Y		
Maximum operating pressure	bar	40			70			
Operation pressure adjustment range	bar	15 ~ 40			15 ~ 70			
Maximum flow*	L/min	15.2	25.1		28.5			
Operation flow rate adjustment range*	L/min	2.5 ~ 15.2	3.5 ~ 25.1		3.5 ~ 28.5			
Motor capacity	equivalent kW	0.75	1.5	2.2	2.8			
Tank capacity	L	18						
Power supply voltage		3~ 200 V (50 Hz), 200 V (60 Hz), 220 V (60 Hz) (Permissible voltage fluctuation: ±10%)				3~ 380 V (50 Hz) / 400 V (60 Hz) / 460 V (60 Hz) (Permissible voltage fluctuation: ±10%)		
Rated current	200V/50Hz	A	6.0	7.0	4.7	10.3	380V / 50Hz	7
	200V/60Hz	A	5.9	7.0	4.5	10.3	400V / 60Hz	6.5
	220V/60Hz	A	5.5	6.7	4.3	9.7	460V / 60Hz	6
No fuse breaker capacity	A	15				10		
External input signal		3 channels, photo coupler insulation, DC 24 V, (maximum of DC 27V), 5 mA per channel						
External output signal	Digital output	1 channel, photo coupler insulation, open collector output, DC 24 V, 50 mA maximum per channel						
	Contact output	1 channel, relay output, contact capacity: DC 30 V, 1 A (resistance load), 1 common contact						
Usable oil**		General petroleum-based hydraulic oil (R&O) / Wear-resistant hydraulic oil • Viscosity grade: ISO VG32 to 68 • Viscosity range: 15 to 400 mm ² /s • Contamination: Within NAS class 10						
Tank oil temperature		0 to 60°C (Recommended operating temperature range: 15 to 50°C)						
Operating ambient temperature		0 ~ 40°C						
Storage ambient temperature		-20 ~ 60°C						
Operating ambient humidity		85% RH maximum (no condensation)						
Waterproof protection rating		IP44						
Installation site		Indoors (Be sure to secure with bolts, etc.)						
Vibration resistance		X direction 4.9 m/s ² Y direction 4.9 m/s ² Z direction 14.7 m/s ² 7.5~100 Hz 2.5 hr						
Altitude		1,000 m maximum						
Standard coating color		Black						
Mass (hydraulic oil excluded)	kg	26			29			

* The maximum flow rate is the theoretical value, not the guaranteed value.
This hydraulic unit is equipped with built-in safety valves.

** Use of hydraulic oils other than mineral-oil base type (e.g. hydrous/synthetic), water-glycol hydraulic oil for example, is prohibited.

ECORICH-R

ECORICH-R combines the latest hydraulics and Daikin technology to achieve even more energy savings and sophisticated operation.

- › Power consumption
The ECORICH-R features a Daikin IPM motor to reduce power consumption by 60% compared to a conventional hydraulic unit.
- › Multi-stage pressure/flow rate control
The operation panel on the unit features 16 different pressure (P) and flow rate (Q) settings to control the cylinder and ensure shockless operation according to the parameter settings.
- › Dry run prevention function
The dry run prevention function stops the unit operation automatically when the oil level in the tank drops lower than a certain level. This function helps protect the pump and extend its service life.
- › Enhanced pressure control
Now available from 5 bar pressure setting.
- › Complies with regulations
All models meet CE standards.



Excluded from high-efficiency motor regulations

	NEW MODEL FALL 2021		NEW MODEL FALL 2021		NEW MODEL FALL 2021		NEW MODEL FALL 2021		NEW MODEL FALL 2021		NEW MODEL FALL 2021		NEW MODEL FALL 2021													
Model code	EHU15R0700-40-03		EHU15R0702-40		EHU15R0703-40-03		EHU15R1000-40-03		EHU15R1002-40		EHU15R1003-40-03		EHU30R0700-40-03		EHU30R0702-40		EHU30R0703-40-03									
Maximum operating pressure	bar		70																							
Operation pressure adjustment range	bar		5-70				15-70				5-100				15-100				5-70				15-70			
Maximum flow rate*	L/min		15.2																							
Operating flow rate range*	L/min		2.5 ~ 15.2												3.5 ~ 28.5											
Motor capacity	equivalent kW		Equivalent to 2.2						Equivalent to 2.8																	
Tank capacity	L		without tank		18		33		without tank		18		33		without tank		18		33							
Power supply	3~ 200-220 V 50/60 Hz (Permissible voltage fluctuation: ±10%) • Be sure to use a commercial power supply for the power source. The use of Inverter power supply may cause burn damage to the unit.																									
Rated current	A		5						10																	
No-fuse breaker capacity	A		10						15																	
External input signal	5 channels, photo coupler insulation, DC 24 V (maximum of DC 27 V), 5 mA per channel																									
External Digital output	2 channels, photo coupler insulation, FET output, DC 24 V, 50 mA maximum per channel																									
output signal Contact output	1 channel, relay output, Contact capacity: DC 30 V, 0.5 A (resistance load), 1 common contact																									
Usable oil**	General petroleum-based hydraulic oil (R&O) / Wear-resistant hydraulic oil (Refer to Daikin*Oil hydraulic brochure* for the oil in detail.) • Viscosity grade: ISO VG32 to 68 • Viscosity range: 15 to 400 mm ² /s • Contamination: Within NAS class 10																									
Tank oil temperature	0 to 60°C (Recommended operating temperature range: 15 to 50°C)																									
Operating ambient temperature	0 ~ 40°C																									
Storage ambient temperature	-20 ~ 60°C																									
Humidity	85% RH maximum (no condensation)																									
Protection grade	IP44																									
Installation site	Indoors (Be sure to secure with bolts, etc.)																									
Vibration resistance	X direction 4.9 m/s ² Y direction 4.9 m/s ² Z direction 14.7 m/s ² 7.5~100 Hz 2.5 hr																									
Altitude	1,000 m maximum																									
Standard coating color	Black (Munsell code N1)		Ivory white (Munsell code 5Y7.5/1)				Black (Munsell code N1)				Ivory white (Munsell code 5Y7.5/1)				Black (Munsell code N1)				Ivory white (Munsell code 5Y7.5/1)							
Mass (hydraulic oil excluded)	kg		26		30		59		26		30		59		26		30		59							
Other	• Be sure to connect a circuit breaker for all (three) poles and the earth leakage breaker. • Make sure that the electrical wiring meets the requirements of European Standard EN60204-1. • Be sure to connect the ground terminal.																									

* The maximum flow rate is the theoretical value, not the guaranteed value.

** Consult Daikin about the use of hydraulic oils other than mineral oil base type (e.g. hydrous/synthetic) such as water-glycol hydraulic oil and Fatty acid ester oil.

SUPER UNIT

The advanced SUPER UNIT offers several different features to achieve higher performance and energy savings.

- › Power consumption
Daikin's original high-efficiency IPM motors with inverter technology provides a 50% increase in energy-savings compared to a conventional hydraulic unit.
- › Multi-stage pressure/flow rate control
The operation panel on the unit features 16 different pressure (P) and flow rate (Q) settings to control the cylinder and ensure shockless operation according to the parameter settings.
- › Low operational noise
The double pump feature helps the SUPER UNIT achieve an operational noise level of 60 dB(A) (when the pressure is at 206 bar), and less than 73 dB(A) in the operating area.
- › Complies with regulations
All models meet CE standards.



Excluded from high-efficiency motor regulations

Function option:

- › Communication function
This function is available for all models and allows remote control and setting changes through an RS232C serial communication.
- › Analogue command input
This function is available for single pump type models and enables continuous control of pressures and speeds as required.

Model code		SUT035 4007-30	SUT065 6007-30	SUT105 8007-30	SUT035 3010-30	SUT035 1516-30	SUT065 3016-30	
Maximum operating pressure	bar	70			100	160		
Operation pressure adjustment range	bar	15 ~ 70			15 ~ 100	15 ~ 160		
Maximum flow*	L/min	39.7	61.1	83.0	25.6	15.2	25.6	
Operation flow rate adjustment range*	L/min	5.3 ~ 39.7	8.7 ~ 61.1	11.6 ~ 83.0	3.4 ~ 25.6	2.4 ~ 15.2	3.4 ~ 25.6	
Motor capacity	equivalent kW	3.7	5.0	7.0	3.7		5.0	
Tank capacity	L	30	60	100	30		60	
Power supply voltage	V	3 ~ 200 V						
Rated current	200V/50Hz	A	16.1	22.1	25.5	18.4	15.2	21.4
	200V/60Hz	A	15.8	21.7	24.8	18.4	15.2	21.4
	220V/60Hz	A	14.8	20.2	22.7	16.9	14.6	20.2
No fuse breaker capacity	A	20	30	50	20		30	
External input signal		5 channels, photo coupler insulation, DC 24 V (maximum of DC 27 V), 5 mA per channel						
External output signal	Digital output	2 channels, photo coupler insulation, FET output, DC 24 V, 50 mA maximum per channel						
	Contact output	1 channel, relay output, Contact capacity: DC 30 V, 0.5 A (resistance load), 1 common contact						
Usable oil**		General petroleum-based hydraulic oil (R&O) / Wear-resistant hydraulic oil (Refer to Daikin "Oil hydraulic brochure" for the oil in detail) • Viscosity grade: ISO VG32 to 68 • Viscosity range: 15 to 400 mm ² /s • Recommendation is from 20-200 mm ² /s • Contamination: Within NAS class 9 (Within Nas class class10 at 70 bar or less pressure) • Volumetric water content: 0.1% maximum						
Tank oil temperature		0 to 60°C (Recommended operating temperature range: 15 to 50°C)						
Operating ambient temperature		0 ~ 40°C						
Storage ambient temperature		-20 ~ 60°C						
Humidity		85% RH maximum (no condensation)						
Installation site		Indoors (Be sure to secure with bolts, etc.)						
Vibration resistance		Motor: 29.4m/s ² 33.3 Hz X,Y direction 2 hr Z direction 4 hr Controller: 21.6m/s ² 33.3 Hz X,Y direction 2 hr Z direction 4 hr						
Altitude		1,000 m maximum						
Standard coating color		Ivory white (Munsell code 5Y7.5/1)						
Mass (hydraulic oil excluded)	kg	64	97	131	64	68	60	
Other		• Be sure to connect a circuit breaker for all (three) poles and the earth leakage breaker • Make sure that the electrical wiring meets the requirements of European Standard EN60204-1 • Be sure to connect the ground terminal						

* The maximum flow rate is the theoretical value, not the guaranteed value.

** Consult Daikin about the use of hydraulic oils other than mineral oil base type (e.g. hydrous/synthetic) such as water-glycol hydraulic oil and Fatty acid ester oil.

SUPER UNIT with double pump specification

This SUPER UNIT combines the efficient Daikin IPM motor and double pump switching control technology.

- › Power consumption
The unit automatically changes the pump combinations, which consist of a single or tandem operation depending on the load condition. At the pressure retained, only the low displacement pump operates, saving a significant amount of energy.
- › Low operational noise
The double pump feature helps the SUPER UNIT achieve an operational noise level of 60 dB(A) (when the pressure is at 206 bar). Adding double phase-differential pumps can reduce the noise level even more.



Excluded from high-efficiency motor regulations

Double pump system

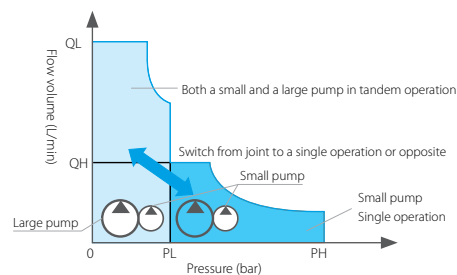
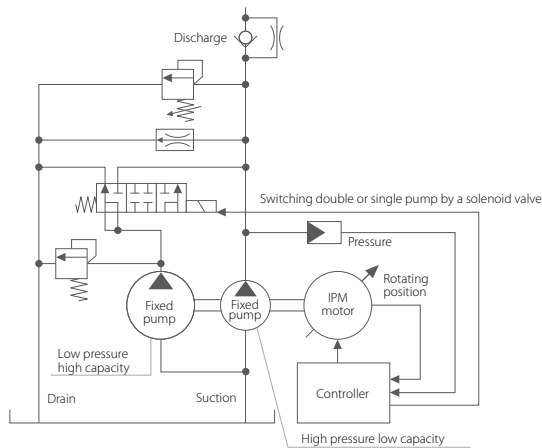

Power consumption \propto Pressure x Flow volume
 Flow volume = Pump capacity x Rotation speed
 Pump capacity is smaller due to a reduction in power consumption during the high pressure retaining operation

Model code	SUT06D 4016	SUT06D 6021	SUT10D 6021	SUT10D 8021	SUT16D 8021	P-SUT20D 11KW
Maximum operating pressure	bar	157	206	206	206	206
Operation pressure adjustment range	bar	15 ~ 160	15 ~ 206	15 ~ 206	15 ~ 206	15 ~ 206
Maximum flow rate*	L/min	41.0	61.1	83.0	110	110
Operation flow rate range*	L/min	5.4 ~ 41.0	8.7 ~ 61.1	11.6 ~ 83.0	13.3 ~ 110	13.3 ~ 110
Motor capacity	equivalent kW	Equivalent to 3.7	Equivalent to 5.0	Equivalent to 7.0	Equivalent to 11.0	Equivalent to 11.0
Tank capacity	L	60	60	100	100	160
Power supply		3 ~ 200 V (50 Hz), 200 V (60 Hz), 220 V (60 Hz) (Permissible voltage fluctuation: $\pm 10\%$) Be sure to use a commercial power supply for the power source. The use of the Inverter power supply may cause burn damage to the unit.				
Rated current	200V/50Hz	A	17.9	22.7	25.5	38.3
	200V/60Hz	A	17.7	21.7	24.8	37.8
	220V/60Hz	A	16.5	20.2	22.7	34.9
No fuse breaker capacity	A	20	30	50	75	
External input signal		5 channels, photo coupler insulation, DC 24 V (maximum of DC 27 V), 5 mA per channel				
External output signal	Digital output	2 channels, photo coupler insulation, FET output, DC 24 V, 50 mA maximum per channel				
	Contact output	1 channel, relay output, Contact capacity: DC 30 V, 0.5 A (resistance load), 1 common contact				
Usable oil**		General petroleum-based hydraulic oil (R&O) / Wear-resistant hydraulic oil (Refer to Daikin "Oil hydraulic brochure" for the oil in detail.) • Viscosity grade: ISO VG32 to 68 • Viscosity range: 15 to 400 mm ² /s (Recommendation is from 20-200 mm ² /s) • Contamination: Within NAS class 9 (Within Nas class class10 at 70 bar or less pressure) • Volumetric water content: 0.1% maximum				
Tank oil temperature		0 to 60°C (Recommended operating temperature range: 15 to 50°C)				
Operating ambient temperature		0 ~ 40°C				
Storage ambient temperature		-20 ~ 60°C				
Humidity		85% RH maximum (no condensation)				
Installation site		Indoors (Be sure to secure with bolts, etc.)				
Vibration resistance		Motor: 29.4m/s ² 33.3 Hz X,Y direction 2 hr Z direction 4 hr Controller: 21.6m/s ² 33.3 Hz X,Y direction 2 hr Z direction 4 hr				
Altitude		1,000 m maximum				
Standard coating color		Ivory white (Munsell code 5Y7.5/1)				
Mass (hydraulic oil excluded)	kg	94	99	112	133	145
Other		• Be sure to connect a circuit breaker for all(three)poles and the earth leakage breaker • Make sure that the electrical wiring meets the requirements of European Standard EN60204-1 • Be sure to connect the ground terminal				

* The maximum flow rate is the theoretical value, not the guaranteed value.

** Consult Daikin about the use of hydraulic oils other than mineral oil base type (e.g. hydrous/synthetic) such as water-glycol hydraulic oil and Fatty acid ester oil.

High-accuracy SUPER UNIT

This analogue command input/high-accuracy type SUPER UNIT offers extended operating for high pressure and flow rates.

- › High voltage/high flow rate
This extension offers PQ control with even greater accuracy than conventional SUPER UNITS.
- › Power consumption
Helps industrial machinery such as presses and general industrial machines achieve high performance, smooth operation and higher energy efficiency.
- › High accuracy
Achieving stable servo control in response to analog input voltages over a range from low pressure (1%)/flow rate (1%) to the maximum pressure/flow rate.
- › Operational commands
All models allow selection of the input type as the analogue command input type or 8-PQ digital command input type using a parameter.



Excluded from high-efficiency motor regulations

Model list

Flow rate / pressure combinations other than those given in the model list below are also available. Please consult with a Daikin expert when considering your options.

Maximum discharge rate	SUPER UNIT (analogue command input, high-accuracy type)									
	Pressure/flow rate model list									
300 L / min			SUT00D30021		37	The numbers indicate the nominal motor capacity (kW).		SUT00D30028		37
260 L / min			SUT00D26021		37			SUT00D20025		22
220 L / min										SUT00D22028
200 L / min	SUT00S20018	22	SUT00D20021			15	SUT00D20025		22	
150 L / min	SUT00S15018	15	SUT00D15021			15				
130 L / min	SUT00S13018	15	SUT00S13021	15	SUT00D13021	15	SUT00D13025		15	
80 L / min	SUT00S8018		SUT00D8021			11	SUT00D8025		11	
50 L / min			SUT00S5021			11	SUT00S5025		15	
30 L / min	SUT00S3018	7	SUT00D3021			7				
Maximum operating pressure	176 bar		206 bar			250 bar		280 bar		

Note 1 All models allow selection of the input type as the analogue command input type or 8-PQ digital command input type using a parameter. (Factory default is the analogue command input type.)
 Note 2 All models are tankless units with a split type controller (electrical components).
 Note 3 When a discharge rate higher than 300 L/min is required, combine multiple SUPER UNITS.
 Note 4 Consult Daikin if you use hydrous/synthetic oils such as water-glycol hydraulic oil or other non-petroleum oils.

Case studies

SUPER UNIT case study

Improving the efficiency of press machines

A conventional hydraulic unit that works continuously during the pressure retaining period can lead to higher energy consumption. With a SUPER UNIT, the system can reduce the rotational speed of the motor during the pressurising process to lower power consumption and save energy costs.

Comparison of power consumption

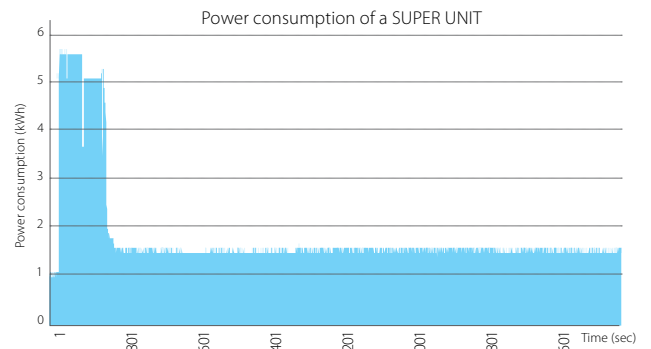
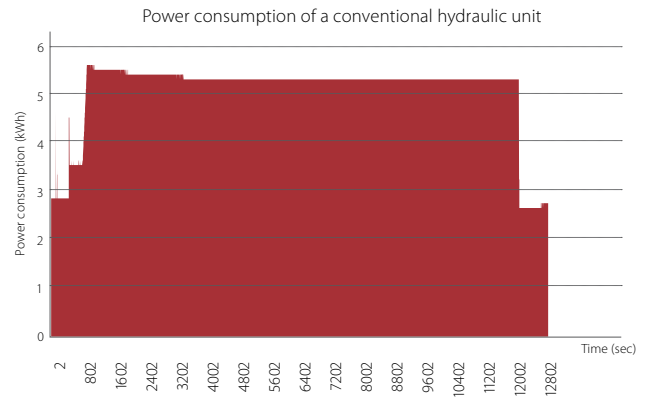
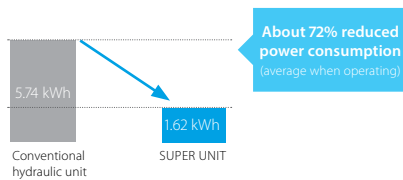

		Model	Pressure	Motor capacity	Tank capacity
Before	Conventional hydraulic unit	Tandem gear pump	125 bar	5.5 kW	200 L
After	SUPER UNIT	SUT10D6021	125 bar	Equivalent to 5.0 kW	100 L

Cost down by energy-saving effect for one year: \$ 4,620

*CO₂ gas reduction for one year: 18.3 t down

- Reduced costs after one year of using a SUPER UNIT*
- Reduced CO₂ emissions after one year**

ECORICH-R case study

Improving the efficiency of machining centres

Daikin technologies optimised every facet of the ECORICH-R to attain higher energy savings than a conventional hydraulic unit. The efficient operating system of the ECORICH-R reduces overall energy consumption and provides better control of the oil temperature to prevent damage and extend the service life of the oil.

Comparison of power consumption

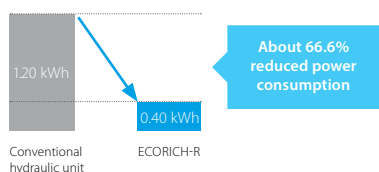

Tank Oil tank temperature: 27°C lower
 Conventional hydraulic pump: 57°C
 ECORICH-R: 30°C

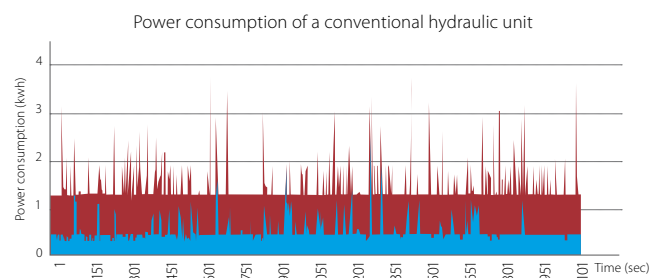

		Model	Pressure	Tank capacity
Before	Conventional hydraulic unit	Piston pump	65 bar	10 L
After	ECORICH-R	EHU30R-M0701	65 bar	10 L

* This is an energy-saving case study in Japan. We assume that operating time is 8,000 hours for one year and ¥15 per kWh (\$1=¥107).
 ** Wh x 0.555 (kg): The low global warming control according to Article 3.1 in Japan.



Daikin Fluid cooling units combine hydraulic technology and our patented inverter technology to achieve high-accuracy temperature control. This feature cools the headstock and eliminates thermal deviation to improve machine function and precision.

Fluid cooling units

Main features.....	26
The full cooling unit range	28
AKZ.....	30
AKJ.....	32
AKJ W.....	33
AKC.....	34
AKW.....	35
Hybrid-Win.....	36
Application.....	37

Main features

High-accuracy oil temperature control

During the metalworking process, a machine will generate lots of heat and oil temperature will increase. Daikin Fluid cooling units use inverter technology to accurately control oil temperature and help a machine perform at its best.

How it works at a glance

A non-inverter cooling unit can't change the revolutions of a compressor, only the on/off function. A Daikin Fluid cooling unit uses an inverter to send revolutions directly to the compressor and a pulse control of expansion valve based on heat generation load, leading to a more precise oil temperature and increased energy savings.

Comparison of inlet oil temperature control

On/off model

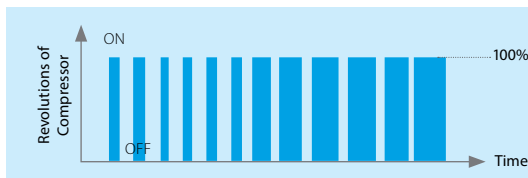
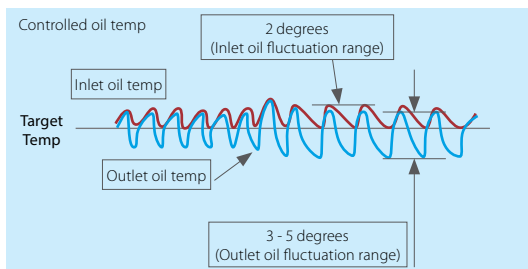
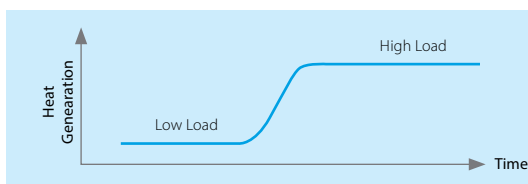

High-accuracy temperature control

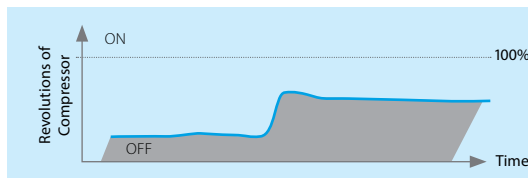
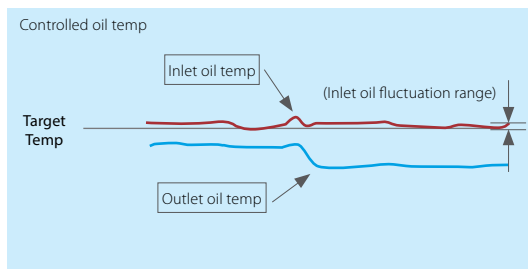
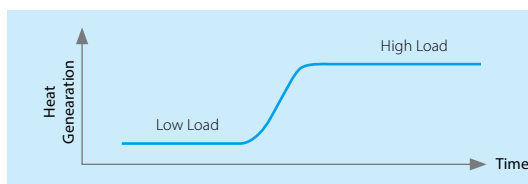

Example of high-accuracy temperature control

Metalworking results (surface level)



Daikin inverter

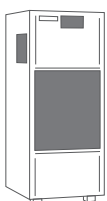

Non-inverter

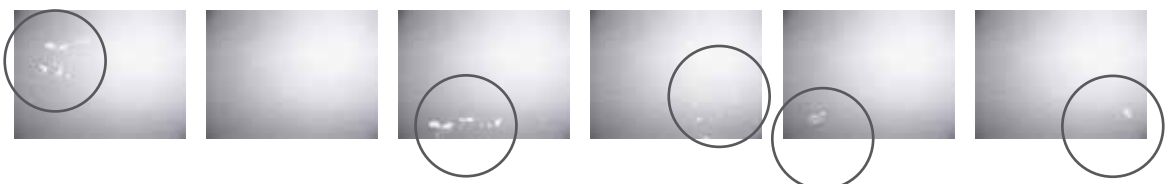

These images show the metalworking results between a unit that uses a non-inverter and one that uses a Daikin inverter. With high-accuracy temperature control, a unit will deliver better metalworking results.

Predictive maintenance

Built-in warning system reminds you the maintenance timing for air filter, condenser, etc., which prevents sudden stop and reduces down time.

Various cooling methods

Engineers can adapt the Daikin Fluid cooling unit to match their machine preferences, including:

- > The target control (inlet, outlet, return).
- > Temperature control (fixed setting, ambient, machine body).
- > Nine different operation mode patterns.

These adaptable functions ensure the Fluid cooling unit provides the correct temperature control for every machine.

Choose from nine operating modes



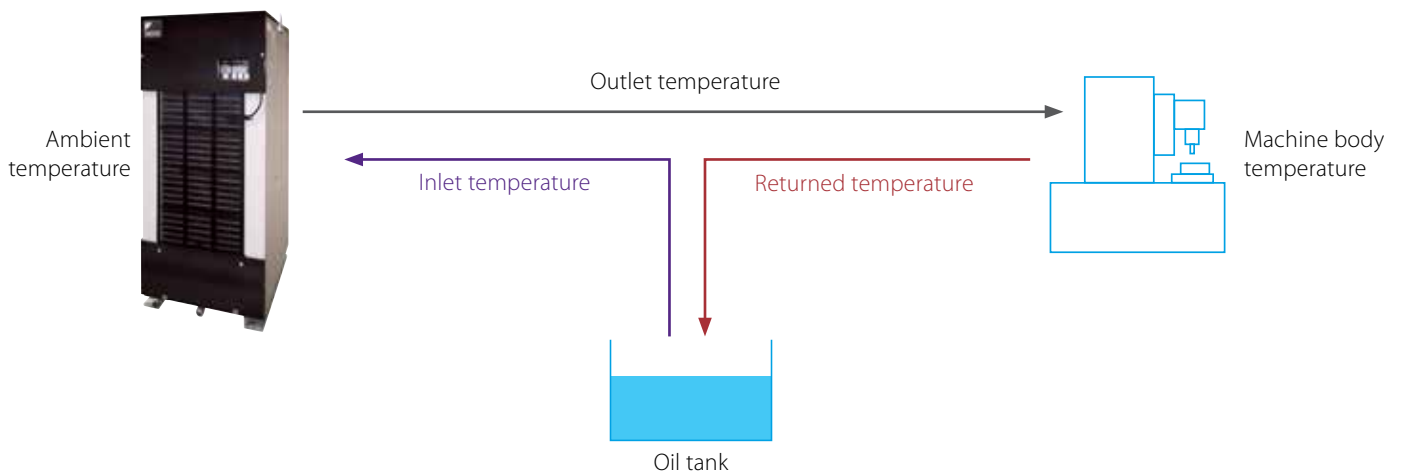

Temperature adjustment	Target temperature	Required option parts
Fixed type	Inlet oil/water	
	Outlet oil/water	
	Returned oil/water	Returned oil/water thermistor
Synchronisation type (Ambient)	Inlet oil/water	
	Outlet oil/water	
	Returned oil/water	Returned oil/water thermistor
Synchronization type (Machine body)	Inlet oil/water	Machine body thermistor
	Outlet oil/water	Machine body thermistor
	Returned oil/water	Machine body & Returned oil/water thermistors



The full cooling unit range

Daikin offers several cooling units to meet the needs of different applications, designs and installation preferences.

You can also choose between a circulation or immersion type unit. Circulation type places the heat exchanger inside the cooling unit, while an immersion type contains a coil heat exchanger below the unit.

Product name	Model	Product picture	Cooling unit horsepower (HP)	Cooling capacity 50 / 60 Hz (kW)	Compressor (totally enclosed DC swing type)
Oil cooling unit Circulation type AKZ9 series	AKZ149		0.5	1.3 / 1.4	Equivalent to 0.4 kW
	AKZ329		1.2	2.8 / 3.2	Equivalent to 0.75 kW
	AKZ439		1.5	3.8 / 4.3	Equivalent to 1.1 kW
	AKZ569		2.0	5.0 / 5.6	Equivalent to 1.5 kW
	AKZ909		3.0	8.0 / 9.0	Equivalent to 2.2 kW
Coolant cooling unit Immersion type AKJ9 series	AKJ189		0.5	1.6 / 1.8	Equivalent to 0.4 kW
	AKJ359		1.2	3.2 / 3.5	Equivalent to 0.75 kW
	AKJ459		1.5	4.2 / 4.5	Equivalent to 1.1 kW
	AKJ569		2.0	5.0 / 5.6	Equivalent to 1.5 kW
	AKJ909		3.0	8.0 / 9.0	Equivalent to 2.2 kW
	AKJ1509		5.0	15.0 / 15.0	Equivalent to 3.7 kW
Coolant cooling unit Water-cooled immersion type AKJ9W series	AKJ189W		0.5	1.6 / 1.8	Equivalent to 0.4 kW
	AKJ359W		1.2	3.2 / 3.5	Equivalent to 0.75 kW
	AKJ459W		1.5	4.2 / 4.5	Equivalent to 1.1 kW
	AKJ569W		2.0	5.0 / 5.6	Equivalent to 1.5 kW
	AKJ909W		3.0	8.0 / 9.0	Equivalent to 2.2 kW
Coolant cooling unit Circulation type AKC9 series	AKC359		1.2	3.5 / 3.5	Equivalent to 0.75 kW
	AKC569		2.0	5.6 / 5.6	Equivalent to 1.5 kW
Water cooling unit Circulation type AKW9 series	AKW149		0.5	1.4 / 1.4	Equivalent to 0.4 kW
	AKW329		1.2	3.2 / 3.2	Equivalent to 0.75 kW
	AKW439		1.5	4.3 / 4.3	Equivalent to 1.1 kW
	AKW569		2.0	5.6 / 5.6	Equivalent to 1.5 kW
	AKW909		3.0	9.0 / 9.0	Equivalent to 2.2 kW

Refrigerant: R-410A for all models.

Oil pump - Theoretical discharge rate 50 / 60 Hz (L / min.)	Water pump head 50 / 60Hz (m)	Max. Power consumption - Max. Current consumption			External dimensions H x W x D (mm)	Mass (kg)	Different voltage
		200 V 50 Hz	200 V 60 Hz	220 V 60 Hz			
12 / 14.4	-	0.90 kW / 3.9 A	0.91 kW / 3.6 A	0.91 kW / 3.5 A	650 x 360 x 440	51	Available
24 / 28.8		1.36 kW / 4.9 A	1.43 kW / 4.8 A	1.43 kW / 4.6 A	775 x 360 x 440	56	Available
		1.80 kW / 6.6 A	1.88 kW / 6.4 A	1.88 kW / 6.1 A	875 x 360 x 440	64	Available
30 / 36		2.22 kW / 7.6 A	2.30 kW / 7.5 A	2.30 kW / 7.2 A	1,110 x 470 x 560	82	Available
		4.25 kW / 13.5 A	4.30 kW / 13.4 A	4.30 kW / 12.9 A	1,220 x 560 x 680	97	Available
-	-	0.82 kW / 3.3 A	0.83 kW / 3.2 A	0.83 kW / 3.0 A	920 x 360 x 440	38	Available
		1.37 kW / 5.2 A	1.38 kW / 5.1 A	1.39 kW / 4.8 A	1,045 x 360 x 440	44	Available
		1.46 kW / 5.6 A	1.48 kW / 5.4 A	1.48 kW / 5.1 A	1,200 x 360 x 440	50	Available
		2.77 kW / 9.4 A	2.72 kW / 9.2 A	2.83 kW / 8.9 A	1,440 x 470 x 500	72	Available
		3.38 kW / 10.8 A	3.43 kW / 10.7 A	3.43 kW / 10.2 A	1,615 x 560 x 620	89	Available
		5.40 kW / 17.3 A	5.37 kW / 16.9 A	5.40 kW / 15.7 A	1,960 x 735 x 725	140	Available
-	-	0.72 kW / 2.9 A	0.71 kW / 2.8 A	0.72 kW / 2.7 A	920 x 360 x 440	45	
		1.36 kW / 5.2 A	1.36 kW / 5.1 A	1.37 kW / 4.8 A	1,045 x 360 x 440	52	
		1.38 kW / 5.3 A	1.38 kW / 5.2 A	1.39 kW / 4.9 A	1,200 x 360 x 440	61	
		2.25 kW / 7.7 A	2.25 kW / 7.4 A	2.24 kW / 6.9 A	1,440 x 470 x 500	86	
		4.13 kW / 13.5 A	4.14 kW / 13.3 A	4.13 kW / 12.1 A	1,615 x 560 x 620	107	
-	-	1.17 kW / 4.2 A	1.22 kW / 4.3 A	1.21 kW / 4.1 A	995 x 450 x 560	83	
-		1.78 kW / 6.2 A	1.87 kW / 6.3 A	1.86 kW / 6.1 A	1,200 x 470 x 670	100	
-	25 / 37	1.20 kW / 4.5 A	1.36 kW / 4.8 A	1.36 kW / 4.8 A	690 x 360 x 700	61	
-	24 / 36	1.71 kW / 6.4 A	1.87 kW / 6.6 A	1.87 kW / 6.6 A	815 x 360 x 700	65	
-		1.97 kW / 7.4 A	2.20 kW / 7.8 A	2.20 kW / 7.8 A	915 x 360 x 700	68	
-	23 / 41	2.95 kW / 9.5 A	3.15 kW / 9.8 A	3.14 kW / 9.0 A	1,197 x 470 x 500	92	Available
-	30 / 55	4.60 kW / 14.3 A	4.91 kW / 15.0 A	4.90 kW / 13.7 A	1,309 x 560 x 620	115	Available

AKZ - Oil cooling unit (Circulation type)

This unit offers precise temperature control and lower operational noise than its predecessor.

- › High-accuracy temperature control with Daikin inverter.
- › Greater energy-savings performance.
- › An extended cooling capacity range.
- › Design meets the latest environmental regulations.
- › The unit achieves low operational noise in the low-load range*.

* As low as 58 dB(A), when room temperature is 25°C and heat load is at 1 kW.
Anechoic greenhouse conversion value (AKZ439 class) AKZ8 series AKZ9 series.



Excluded from high-efficiency motor regulations

9 series

Model code		AKZ149	AKZ329	AKZ439	AKZ569	AKZ909	
Cooling unit horsepower	HP	0.5	1.2	1.5	2.0	3.0	
Cooling capacity (50/60Hz)*	kW	1.3 / 1.4	2.8 / 3.2	3.8 / 4.3	5.0 / 5.6	8.0 / 9.0	
Compressor (Hermetic DC swing type)		Equivalent to 0.4 kW	Equivalent to 0.75 kW	Equivalent to 1.1 kW	Equivalent to 1.5 kW	Equivalent to 2.2 kW	
Oil pump theoretical discharge rate (50/60Hz)	L/min	12 / 14.4	24 / 28.8		30 / 36		
Refrigerant		R-410A					
Power supply voltage**	Main circuit	3-phase AC 200/200-220 V 50/60 Hz					
	Operation circuit	DC12/24 V					
Max. power consumption	200 V / 50 Hz	0.90 kW / 3.9 A	1.36 kW / 4.9 A	1.80 kW / 6.6 A	2.22 kW / 7.6 A	4.25 kW / 13.5 A	
	200 V / 60 Hz	0.91 kW / 3.6 A	1.43 kW / 4.8 A	1.88 kW / 6.4 A	2.30 kW / 7.5 A	4.30 kW / 13.4 A	
Max. current consumption	200 V / 60 Hz	0.91 kW / 3.5 A	1.43 kW / 4.6 A	1.88 kW / 6.1 A	2.30 kW / 7.2 A	4.30 kW / 12.9 A	
	220 V / 60 Hz						
External dimensions (H x W x D)	mm	650 x 360 x 440	775 x 360 x 440	875 x 360 x 440	1,110 x 470 x 560	1,220 x 560 x 680	
Mass	kg	51	56	64	82	97	
Items prepared by the customer	Moulded-case circuit breaker (Rated current)	A	10 (Required for types other than -B)***			15 (Required for types other than -B) ***	20 (Required for types other than -B) ***

* The cooling capacity indicates the value at the standard point (inlet oil temperature: 35°C, room temperature: 35°C, oil used: VG32, 1 atm). This unit has about ± 5% of product tolerance.

** Use a commercial power supply for the power source. The use of an inverter power supply may cause burn damage to the machine. The voltage fluctuation range should be within ±10%. If it is more than ±10%, please consult us.

*** The moulded-case circuit breaker is not supplied with this product. Please prepare it yourself.

Options and their combinations

Option symbol	With breaker	Compliance with CE	With heater	With tank	Voltage type (1) AC 220 - 230 V	Voltage type (3) AC 440 - 460 - 480 V
-B	✓					
-C		✓				
-H			✓			
-T				✓		
-046					✓	
-048	✓					✓

Voltage type (3) is with breaker.
Combination of options is possible.

Brand new 400 V model has appeared: 10 series

AKZ 10 series is Daikin's brand-new offers of oil cooling unit, whose design is even more compact than their predecessor and maintenance is easier.

Compact design

400 V chiller without transformer, which minimize the size of the unit.

Easy maintenance

The air filter is improved to reduce the cleaning work of the clogging by oil mist, which prevent sudden stop and down time.

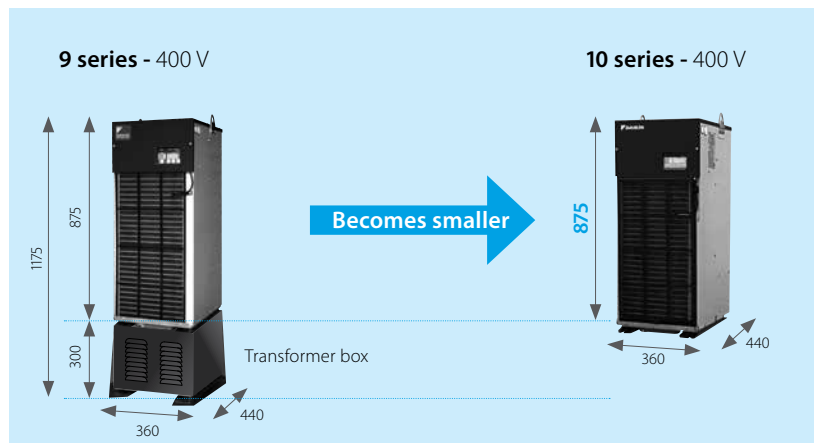

Comparison between AKZ439 and AKZ43A-500 (Unit : mm)

10 series

Model code		AKZ14A-500	AKZ32A-500	AKZ43A-500	AKZ56A-500	AKZ90A-500	
Cooling unit horsepower	HP	0.5	1.2	1.5	2.0	3.0	
Cooling capacity (50/60Hz)*	kW	1.3 / 1.4	2.8 / 3.2	3.8 / 4.3	5.0 / 5.6	8.0 / 9.0	
Compressor (Hermetic DC swing type)		Equivalent to 0.4 kW	Equivalent to 0.75 kW	Equivalent to 1.1 kW	Equivalent to 1.5 kW	Equivalent to 2.2 kW	
Oil pump theoretical discharge rate (50/60Hz)	L/min	12 / 14.4	24 / 28.8		30 / 36		
Refrigerant		R-410A					
Power supply voltage**	Main circuit	3-phase AC 380•400•415V 50/60Hz					
	Operation circuit	DC12/24V					
Max. power consumption Max. current consumption	380 V 50 / 60 Hz	1.01 kW / 2.3 A	1.59 kW / 3.1 A	1.99 kW / 3.6 A	2.48 kW / 4.3 A	4.32 kW / 8.1 A	
	400 V 50 / 60 Hz	1.02 kW / 2.2 A	1.60 kW / 3.0 A	1.99 kW / 3.5 A	2.50 kW / 4.2 A	4.35 kW / 7.6 A	
	415 V 50 / 60 Hz	1.03 kW / 2.2 A	1.60 kW / 2.9 A	2.00 kW / 3.4 A	2.50 kW / 4.3 A	4.38 kW / 7.7 A	
External dimensions (H x W x D)	mm	650 x 360 x 440	775 x 360 x 440	875 x 360 x 440	1,110 x 470 x 560	1,220 x 560 x 680	
Mass	kg	55	61	65	84	102	
Items prepared by the customer	Moulded-case circuit breaker (Rated current)	A	10 (Required for types other than -B)***			15 (Required for types other than -B)***	20 (Required for types other than -B)***

* The cooling capacity indicates the value at the standard point (inlet oil temperature: 35°C, room temperature: 35°C, oil used: VG32, 1 atm). This unit has about ± 5% of product tolerance.

** Use a commercial power supply for the power source. The use of an inverter power supply may cause burn damage to the machine.

The voltage fluctuation range should be within ±10%. If it is more than ±10%, please consult us.

*** The moulded-case circuit breaker is not supplied with this product. Please prepare it yourself.

**** The figures of AKZ56A-500 and AKZ90A-500 are approximate.

Options and their combinations

Option symbol	With breaker	Compliance with CE	With heater	With tank
-B	✓			
-C		✓		
-H			✓	
-T				✓

Combination of options is possible.

AKJ - Coolant cooling unit (Immersion type)

This compact unit is versatile to suit installation on the tank while delivering the same high energy performance.

- › A cooler mounted directly on the coolant tank (circulation pump not included).
- › Superior energy-saving performance.
- › Design is even more compact than the top-class unit in the industry.
- › Enhanced support for shallow tanks with the reduced cooling coil depth.
- › An extended cooling capacity range.



Model code		AKJ189	AKJ359	AKJ459	AKJ569	AKJ909	AKJ1509	
Oil cooling unit horsepower	HP	0.5	1.2	1.5	2.0	3.0	5.0	
Cooling capacity (50/60Hz)*	kW	1.6 / 1.8	3.2 / 3.5	4.2 / 4.5	5.0 / 5.6	8.0 / 9.0	15.0 / 15.0	
Compressor (Hermetic DC swing type)		Equivalent to 0.4 kW	Equivalent to 0.75 kW	Equivalent to 1.1 kW	Equivalent to 1.5 kW	Equivalent to 2.2 kW	Equivalent to 3.7 kW	
Refrigerant		R-410A						
Power voltage**	Main circuit	3-phase AC 200/200-220 V 50/60 Hz						
	Operation circuit	DC12/24 V						
Max. power consumption Max. current consumption	200 V / 50 Hz	0.82 kW / 3.3 A	1.37 kW / 5.2 A	1.46 kW / 5.6 A	2.77 kW / 9.4 A	3.38 kW / 10.8 A	5.40 kW / 17.3 A	
	200 V / 60 Hz	0.83 kW / 3.2 A	1.38 kW / 5.1 A	1.48 kW / 5.4 A	2.72 kW / 9.2 A	3.43 kW / 10.7 A	5.37 kW / 16.9 A	
	220 V / 60 Hz	0.83 kW / 3.0 A	1.39 kW / 4.8 A	1.48 kW / 5.1 A	2.83 kW / 8.9 A	3.43 kW / 10.2 A	5.40 kW / 15.7 A	
External dimensions H x W x D	mm	920 x 360 x 440	1,045 x 360 x 440	1,200 x 360 x 440	1,440 x 470 x 500	1,615 x 560 x 620	1,960 x 735 x 725	
Mass	kg	38	44	50	72	89	140	
Items prepared by the customer	Moulded-case circuit breaker (Rated current)	A			10 (Required for types other than -B)***	15 (Required for types other than -B)***	20 (Required for types other than -B)***	30 (Required for types other than -B)***
	Device other than moulded-case circuit breaker	Tank, supply pump, float switch, return filter, water strainer						

* The cooling capacity indicates the value at the standard point (tank fluid temperature: 35°C, room temperature: 35°C, oil used: AKJ189 ~ 909 : ISOVG32, AKJ1509: water, 1 atm). This unit has about ± 5% of product tolerance.

** Use a commercial power supply for the power source. The use of an inverter power supply may cause burn damage to the machine. The voltage fluctuation range should be within ±10%. If it is more than ±10%, please consult us.

*** The moulded-case circuit breaker is not supplied with this product. Please prepare it yourself.

Options and their combinations

Option symbol	With breaker	Compliance with CE	With heater	Voltage Type (1) AC 220 • 230	Voltage Type (2) AC 380 • 400 • 415 V	Voltage Type (3) AC 440 • 460 • 480 V
-B	✓					
-C		✓				
-H			✓			
-046				✓		
-047	✓				✓	
-048	✓					✓

Voltage type (2) and (3) are with breaker.
Combination of options is possible.

AKJW - Coolant cooling unit (Immersion type)

This unit contains a water-cooled condenser to prevent exhaust heat and achieve excellent performance.

- › A cooler mounted directly on the coolant tank (circulation pump not included).
- › High-accuracy temperature control with Daikin inverter.
- › Water cooled condenser prevents exhaust heat from the unit.
- › Easy maintenance for extended service life.
- › Specifications are compatible with air-cooled units.

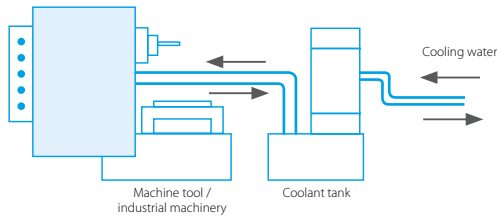

Advantages of a water-cooled condenser

Prevent exhaust heat

- › Achieve a comfortable work environment for employees.
- › Reduce air conditioning load to attain higher energy savings.
- › Realise stable machine performance due to temperature control.

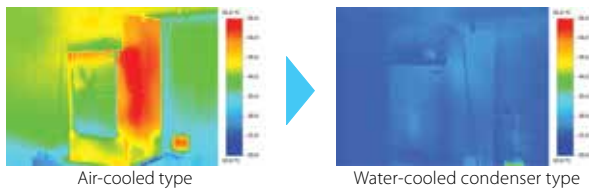

Easy maintenance

The clog-resistant double tube condenser makes cleaning faster.



Compatible with air-cooled units

Easy to replace an existing air-cooled condenser type unit with this water-cooled model if cooling water is available.

Model code		AKJ189W	AKJ359W	AKJ459W	AKJ569W	AKJ909W	
Oil cooling unit horsepower	HP	0.5	1.2	1.5	2.0	3.0	
Cooling capacity (50/60 Hz)*	kW	1.6/1.8	3.2/3.5	4.2/4.5	5.0 / 5.6	8.0 / 9.0	
Compressor (Hermetic DC swing type)		Equivalent to 0.4 kW	Equivalent to 0.75 kW	Equivalent to 1.1 kW	Equivalent to 1.5 kW	Equivalent to 2.2 kW	
Refrigerant		R-410A					
Power voltage**	Main circuit	3-phase AC 200/200-220 V 50/60 Hz					
	Operating circuit	DC12/24 V					
Max. power consumption	200 V 50 Hz	0.72kW/2.9A	1.36kW/5.2A	1.38kW/5.3A	2.25 kW / 7.7 A	4.13 kW / 13.5 A	
Max. current consumption	200 V 60 Hz	0.71kW/2.8A	1.36kW/5.1A	1.38kW/5.2A	2.25 kW / 7.4 A	4.14 kW / 13.3 A	
	220 V 60 Hz	0.72kW/2.7A	1.37kW/4.8A	1.39kW/4.9A	2.24 kW / 6.9 A	4.13 kW / 12.1 A	
External dimensions (H x W x D)	mm	920 x 360 x 440	1,045 x 360 x 440	1,200 x 360 x 440	1,440 x 470 x 500	1,615 x 560 x 620	
Mass	kg	45	52	61	86	107	
Items prepared by the customer	Moulded-case circuit breaker (Rated current)	A			10 (Required for types other than -B)***	15 (Required for types other than the -B type)***	20 (Required for types other than the -B type)***
	Device other than moulded-case circuit breaker	Tank, supply pump, float switch, return filter, water strainer					

* The cooling capacity indicates the value at the standard point (tank fluid temperature: 35°C, primary-side cooling water temperature: 35°C, primary-side cooling water volume: 42 L/min, fluid used: ISO VG32, 1 atm). This unit has about ± 5% of product tolerance.

** Use a commercial power supply for the power source. The use of an inverter power supply may cause burn damage to the oil cooling unit. The voltage fluctuation range should be within ± 10%. If it is more than ± 10%, please consult us.

*** The moulded-case circuit breaker is not supplied with this product. Please prepare it yourself.

Options and their combinations

Option symbol	With breaker	Compliance with CE	With heater
-B	✓		
-C		✓	
-H			✓
-BC	✓	✓	
-BH	✓		✓
-CH		✓	✓
-BCH	✓	✓	✓

AKC - Coolant cooling unit (Inline type)

This unit is an easy retrofit for existing tanks and features an enhanced evaporator to prevent clogging.

- › High-accuracy temperature control with Daikin inverter.
- › Greater energy-savings performance.
- › Design meets the latest environmental regulations.
- › Easy maintenance for end users.
- › Durable against oil mist and dust.



Model code		AKC359	AKC569
Oil cooling unit horsepower	HP	1.2	2.0
Cooling capacity (50 / 60 Hz)*	kW	3.5 / 3.5	5.6 / 5.6
Compressor (Hermetic DC swing type)		Equivalent to 0.75 kW	Equivalent to 1.5 kW
Refrigerant		R-410A	
Power voltage**	Main circuit	3-phase AC 200 / 200-220 V 50/60 Hz	
	Operation circuit	DC12 / 24V	
Max. power consumption	200 V / 50 Hz	1.17 kW / 4.2 A	1.78 kW / 6.2 A
Max. current consumption	200 V / 60 Hz	1.22 kW / 4.3 A	1.87 kW / 6.3 A
	220 V / 60 Hz	1.21 kW / 4.1 A	1.86 kW / 6.1 A
External dimensions HxWxD	mm	995 x 450 x 560	1,200 x 470 x 670
Mass	kg	83	100
Moulded-case circuit breaker (builtin)	A	10	15

* The cooling capacity indicates the value at the standard point (inlet oil temperature: 35°C, room temperature: 35°C, oil used: ISO VG32, 1 atm). This unit has about ± 5% of product tolerance.

** Use a commercial power supply for the power source. The use of an inverter power supply may cause burn damage to the machine. The voltage fluctuation range should be within ± 10%. If it is more than ± 10%, please consult us.

Options and their combinations

Option symbol	Compliance with CE	With heater	Unit with pump
-C	✓		
-H		✓	
-200			✓
-CH	✓	✓	
C200	✓		✓
H200		✓	✓
K200	✓	✓	✓

AKW - Water cooling unit (Inverter controlled chiller)

This unit features a Daikin inverter for high-accuracy control.

- › An extended cooling capacity range.
- › Design meets the latest environmental regulations.
- › Achieves 30% more energy savings than the AKW 8 series.
- › The unit achieves low operational noise for a comfortable working environment.



Model code		AKW149(-171)	AKW329(-171)	AKW439(-171)	AKW569	AKW909	
Chiller horsepower	HP	0.5	1.2	1.5	2.0	3.0	
Cooling capacity (50 / 60 Hz)*	kW	1.4 / 1.4	3.2 / 3.2	4.3 / 4.3	5.6 / 5.6	9.0 / 9.0	
Compressor (Totally enclosed DC swing type)		Equivalent to 0.4 kW	Equivalent to 0.75 kW	Equivalent to 1.1 kW	Equivalent to 1.5 kW	Equivalent to 2.2 kW	
Refrigerant		R-410A					
Water pump	Model	Immersion type multistage pump			Cascade pump		
	Head (50 / 60 Hz)	m	25 / 37	24 / 36		23 / 41	
	Motor capacity (50 / 60 Hz)	kW	0.33 / 0.52			0.55 / 0.55	
Power voltage**	Main circuit	3-phase AC 200/200-220 V 50/60 Hz					
	Operation circuit	DC12 / 24V					
Max. power consumption Max. current consumption	200 V / 50 Hz	1.20 kW / 4.5 A	1.71 kW / 6.4 A	1.97 kW / 7.4 A	2.95 kW / 9.5 A	4.60 kW / 14.3 A	
	200 V / 60 Hz	1.36 kW / 4.8 A	1.87 kW / 6.6 A	2.20 kW / 7.8 A	3.15 kW / 9.8 A	4.91 kW / 15.0 A	
	220 V / 60 Hz	1.36 kW / 4.8 A	1.87 kW / 6.6 A	2.20 kW / 7.8 A	3.14 kW / 9.0 A	4.90 kW / 13.7 A	
External dimensions HxWxD	mm	690 x 360 x 700	815 x 360 x 700	915 x 360 x 700	1,197 x 470 x 500	1,309 x 560 x 620	
Mass	kg	61	65	68	92	115	
Items prepared by the customer	Moulded-case circuit breaker (Rated current)	A	10 (Required for types other than -B)***			15 (Required for types other than -B)***	20 (Required for types other than -B)***

* The cooling capacity indicates the value at the standard point (inlet oil temperature: 35°C, room temperature: 35°C, oil used: ISO VG32, 1 atm). This unit has about ±5% of product tolerance.
 ** Use a commercial power supply for the power source. The use of an inverter power supply may cause burn damage to the machine. The voltage fluctuation range should be within ±10%.
 If it is more than ±10%, please consult us.

*** The moulded-case circuit breaker is not supplied with this product. Please prepare it yourself.

Options and their combinations - AKW149 • 459

Option symbol	With breaker	Compliance with CE	With cover
-B	✓		
-C		✓	
-BC	✓	✓	
-171			✓

Options and their combinations - AKW569 • 909

Option symbol	With breaker	Compliance with CE	Voltage type (1) AC 220 • 230 V	Voltage type (2) AC 380 • 400 • 415 V	Voltage type (3) AC 440 • 460 V • 480 V
-B	✓				
-C		✓			
-046			✓		
-047	✓			✓	
-048	✓				✓
-BC	✓	✓			
-001	✓		✓		
-002		✓	✓		
-005	✓	✓	✓		
-017	✓	✓		✓	
-032	✓	✓			✓

Voltage type (2) and (3) are with breaker.

Hybrid-Win



Hybrid-Win is a PC utility software that connects the Daikin hybrid hydraulic units by serial communication, including the ECORICH, SUPER UNIT and Fluid cooling unit. It sends the data to a Windows application where users can set parameters and monitor units.

Equipment configuration

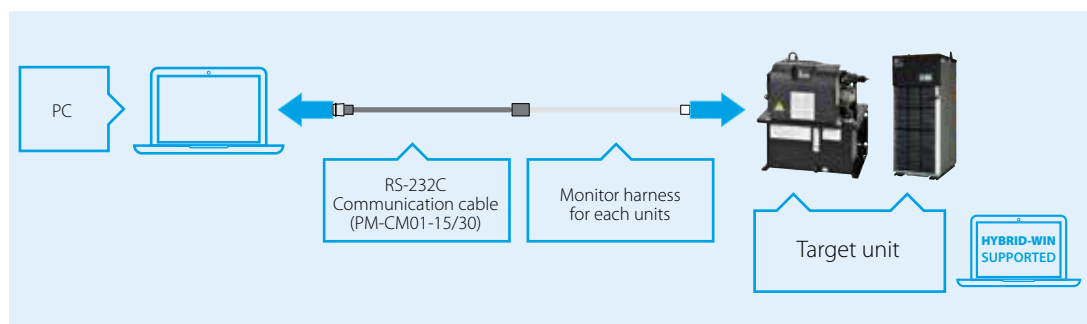

Main features

Create graphs

The pressure, flow rate and other internal data can be monitored and displayed in graphs. These key visuals facilitate operation checks during test runs, parameter adjustments and troubleshooting.

Edit parameter settings

End users can read and write parameters and easily set them to save time. Remote setting is also possible.

Manage alarm history

This function quickly identifies parts that require maintenance to reduce downtime. The operating time display shows when consumable parts need replacing or a maintenance check. Troubleshooting information includes a diagnosis of what caused an alarm and actions to resolve the issue.

Application

The full cooling unit range

Customers can choose a cooling unit based on the liquid the machine uses and installation preferences.

The application and design policy determine the liquid a unit can use. Most machines use oil, water or coolant, which is why Daikin offers several different types of cooling units to meet every type of need.

Daikin also offers two different types of machines: a circulation type and an immersion type. The circulation type unit contains a heat exchanger inside of a cooling unit. In comparison, the immersion type includes a heat exchanger below the unit and install on the top of tank for a smaller installation footprint.

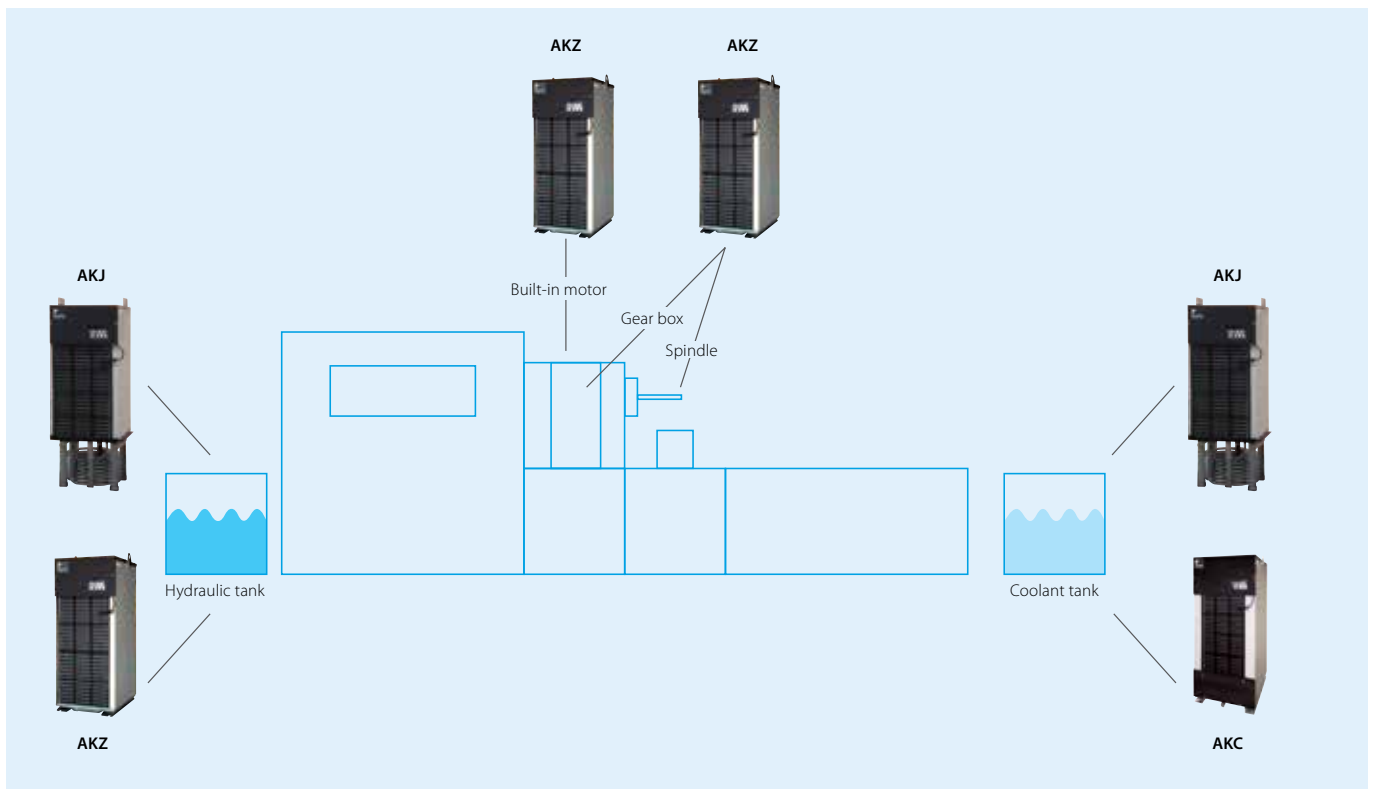

Daikin hybrid hydraulic units come with a range of communication functions to maintain their high performance and energy savings throughout their lifetime. Get real-time performance updates, reminders for maintenance checks and full control to tailor a unit to meet factory needs.

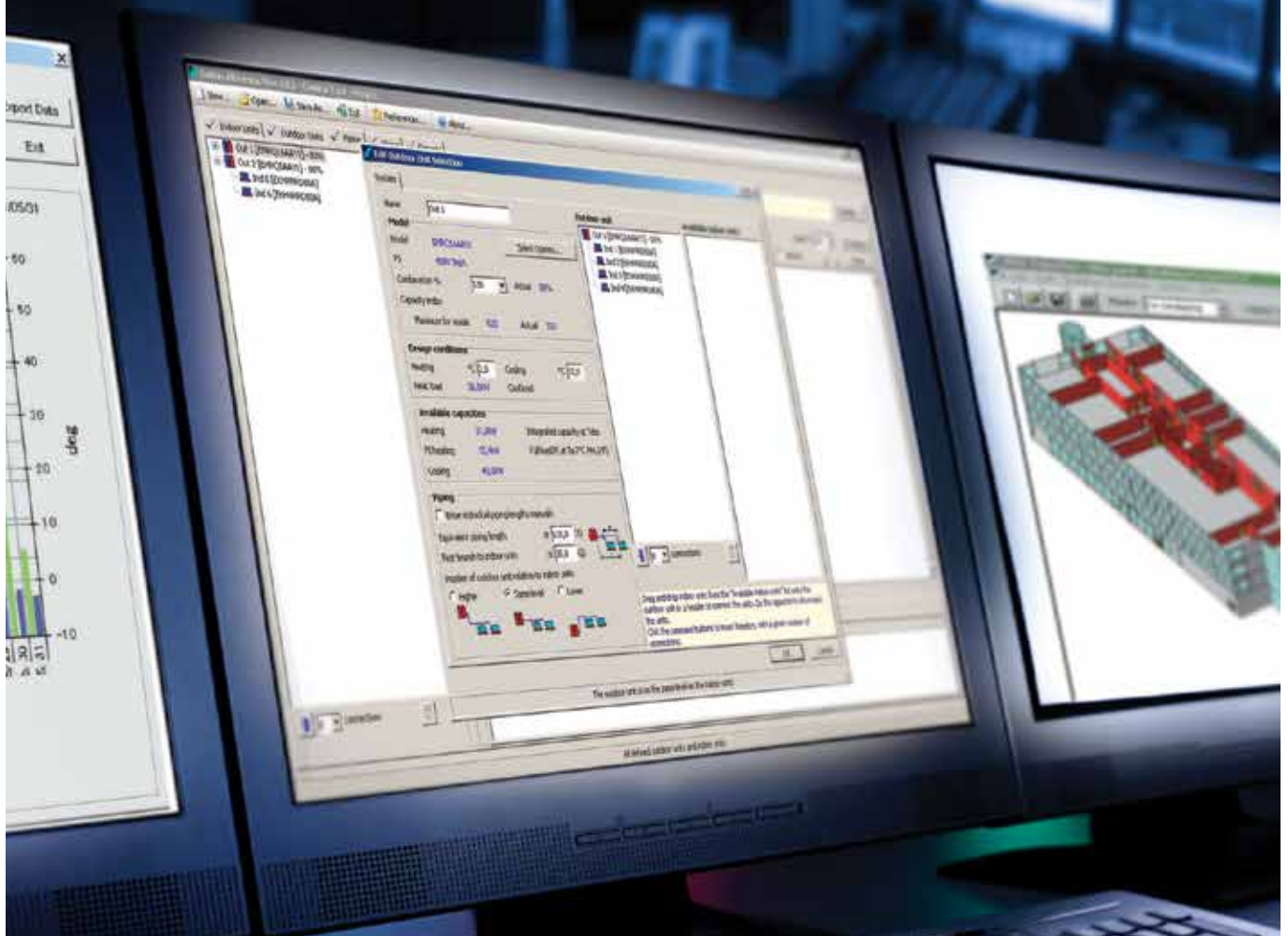

Communication functions

Helping factories get ahead with IoT..... 40
Overview of communication functions..... 41

Helping factories get ahead with IoT

Apparently factories are running smoothly and efficiently, but behind the scenes there are many redundancies and inefficiencies that can bring down productivity. Daikin aims to solve these issues by offering IoT-connected hybrid systems.

How IoT optimises hybrid systems

Processes like periodic inspections or changing filters are essential to keep units running at an optimal level. But these processes can be very demanding and waste time and money.

Daikin Hybrid Systems aim to improve these processes with IoT-enabled solutions. With these optimal systems, workers get important operating data to see when a unit requires inspection and diagnose issues before they happen.

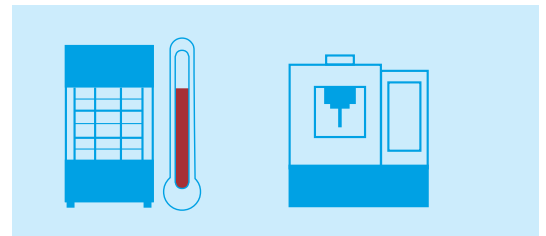

Monitoring the operating status of the Oil cooling unit through a connection with the machine.

The advantages for factory workers

Machine manufacturers

The operating data, maintenance timing and procedures can be displayed on the operation screen to help reduce the machine failure rate, and the working hours spent on inspections.

Machine users

The operating data, maintenance timing and procedures can be displayed on the PC in the maintenance room, reducing the hours spent on inspections.

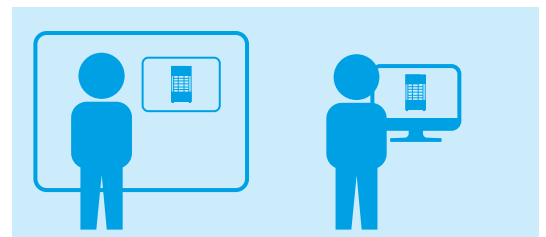

The maintenance procedure can be confirmed on the machine's screen or on a PC.

Overview of communication functions

Perform maintenance checks

With a host device, users can read diagnostics and edit parameters to reduce downtime and ensure the smooth operation of their units.

Host device

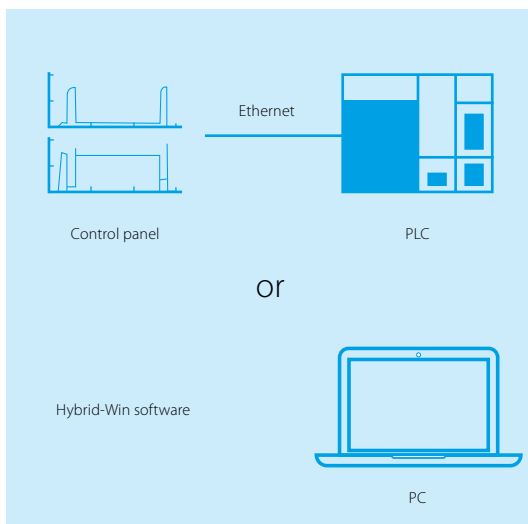

Daikin hybrid unit



Check and update settings

Operators have access to status updates and write parameter settings for hydraulic and cooling units.

Hydraulic unit

View

1. Operating data
2. Parameter values
3. Alarm history

Edit

1. Parameter settings

Cooling unit

View

1. Signal I/O status
2. System status
3. Operating data
4. Temperature data
5. Parameter values

Edit

1. Parameter settings

Panel Indication and Name	Value	Unit
P01, Pressure switch	1234	bar
P28, Pressure switch output dead zone	1234	0.1 bar
P02, Pressure switch output delay time	1234	10 msec
P13, Pressure setting	1234	bar
P13, Flow rate setting	1234	0.1L/min
P14, Pressure setting	1234	bar
P14, Flow rate setting	1234	0.1L/min
P15, Pressure setting	1234	bar
P15, Flow rate setting	1234	0.1L/min
P16, Pressure setting	1234	bar
P16, Flow rate setting	1234	0.1L/min
P03, Pressure switch indication retention setting	1234	-
P00, Start/stop signal switch	1234	-
P10, PQ integration time correction factor	1234	%
P45, Cooling fan motor speed	1234	-
P31, Pressure sensor rated valuse	1234	bar
P32, Surgeless start time	1234	0.01 sec

Read Monitor datas

Pressure set value 1234 bar
 Flow rate set value 123.4 L/min
 Rotation speed 1234 min⁻¹
 Pressure 1234 bar Low rate 234 L/min

Motor temperature 123.4 °C
 Cooling fin temperature 123.4 °C
 I/F board temperature 123.4 °C
 Power consumption 1234 kW

Main circuit DC voltage 1234 V
 Motor load ratio 123.4 %

Total operation time 12345 hour
 Alarm/warning code A12
 Maintenance request 1234

Contact input signal
 Not used Not used Start/Stop
 Contact output signal
 Digital output Ready signal

These are images. Needs to be set by a customer.

Use Hydraulic unit monitoring to prevent issues

Monitoring item	Suspected machine status & operating environment	Suspected hydraulic unit status
1. Flow rate at pressure holding (L/min)	<ul style="list-style-type: none"> Leak in valve, piping or cylinder Fluid viscosity (oil temperature) is changed 	<ul style="list-style-type: none"> Leak in pump or seal due to deterioration
2. Pressure at high speed movement (bar)	<ul style="list-style-type: none"> Increase in cylinder friction 	
3. Moving time (time measuring instrument required)	<ul style="list-style-type: none"> Leak in cylinder Fluid viscosity (oil temperature) is changed 	<ul style="list-style-type: none"> Leak in pump or seal due to deterioration
4. Motor load (%)	<ul style="list-style-type: none"> Average operating load is increasing 	<ul style="list-style-type: none"> Pump deterioration
5. Motor temperature (°C)	<ul style="list-style-type: none"> Average operating load is increasing High room temperature 	<ul style="list-style-type: none"> Pump deterioration Clogged oil cooler
6. Controller temperature (°C)	<ul style="list-style-type: none"> High room temperature 	<ul style="list-style-type: none"> Clogged controller fan

Use Cooling unit monitoring to prevent issues

Monitoring item	Suspected machine status & operating environment	Suspected hydraulic unit status
1. Room temperature (suction air temp in °C)	<ul style="list-style-type: none"> Air exhaust is not enough High room temperature 	
2. Temperature difference between inlet oil and outlet oil	<ul style="list-style-type: none"> Low flow rate due to deteriorated or clogged pump 	<ul style="list-style-type: none"> Clogged air filter Clogged condenser
3. Machine body temperature (or preferred set point in °C)	<ul style="list-style-type: none"> Temperature increase 	
4. Electrical box temperature (°C)	<ul style="list-style-type: none"> High room temperature 	<ul style="list-style-type: none"> Clogged air filter Clogged condenser
5. Cooling command (%)	<ul style="list-style-type: none"> Heat load increase Heat generation due to pump deterioration High room temperature 	<ul style="list-style-type: none"> Clogged air filter Clogged condenser
6. Power consumption (mainly compressor in kW)	<ul style="list-style-type: none"> Heat load is increasing Heat generation due to pump deterioration High room temperature 	<ul style="list-style-type: none"> Clogged air filter Clogged condenser

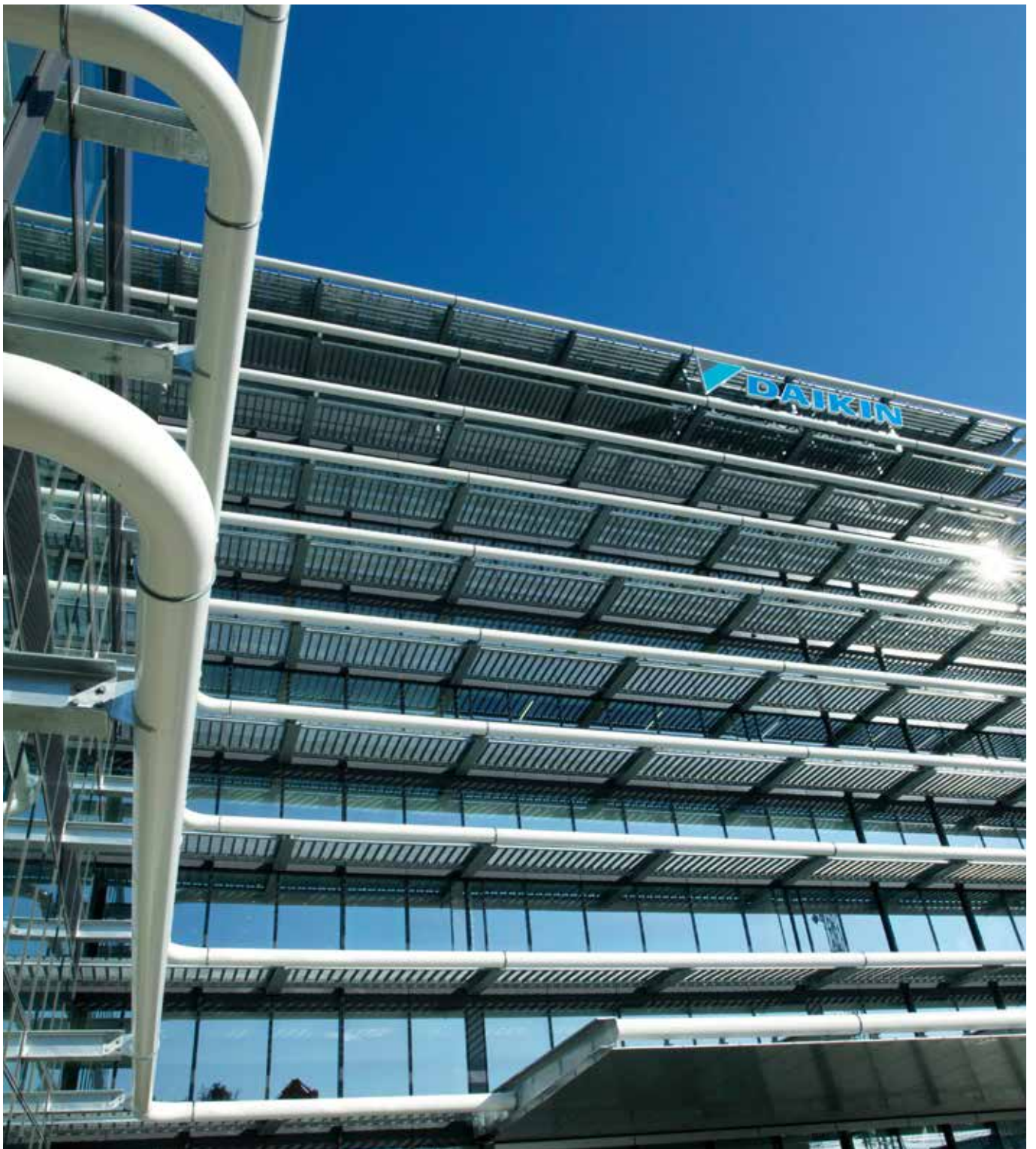

DAIKIN INDUSTRIES, LTD.

Oil Hydraulic Equipment

Osaka Office • Yodogawa Plant

1-1, Nishi-Hitotsuya, Settsu • Osaka 566-8585 • Japan • Phone: 81-6-6349-4475 • Fax: 81-6-6349-7862 • <http://www.daikinpmc.com/en/>

All World Machinery Supply, Inc. • A member of Daikin group

6164 All World Way, Roscoe • IL 61073 • U. S. A. • Phone: +1-815-943-9111 • Fax: +1-815-943-5370 • <http://www.allworldmachinery.com/>

