

**GEAR MOTORS**

**Group 1, 2 and 3 | Technical Information**





## History of revisions

Date	Page	Changed	Rev.
28, June 2010	-	First edition	A
24, Feb 2011	1, 2, 12, 44	Covers to blue color, Turolla brand name, Biofluids deleted.	B
30, Sept 2013	ALL	Layout and options lists	C



# Index

## General Information

- 4 Overview
- 5 Features and Benefits
- 5 Motor Displacements
- 6 Determination of Nominal Motor Size

## System Requirements

- 7 Pressure
- 7 Speed
- 8 Hydraulic Fluids
- 8 Temperature and Viscosity
- 9 Filtration
- 9 Filters
- 9 Selecting a filter
- 9 Reservoir
- 10 Line Sizing
- 10 Motor Shaft Connection
- 11 Motor Shaft Load Data Form
- 12 Motor Life

## Group 1 Gear Motors

- 13 Motor Design
  - 13 SKM1NN
  - 13 SKU1NN
  - 13 SNU1NN
- 14 Technical Data
- 15 Model Code
- 19 Motor performance graphs
- 21 Flange, shaft and port configurations
- 22 Shaft options
- 23 Integral relief valve - SKM1IN
- 24 Ports dimensions
- 25 Dimensions
  - 25 SKM1NN, SKU1NN, SNU1NN – 01BA
  - 26 SKM1NN, SKU1NN – 02BB, 02FA
  - 27 SKM1NN, SKU1NN – 06GA and 06SA

## Group 2 Gear Motors

- 28 Motor design
  - 28 SNM2NN
  - 28 SNU2NN
  - 28 SKU2NN
- 29 Technical data
- 30 Model code
- 36 Motor performance graphs
- 38 Flange, shaft and port configurations
- 39 Shaft options
- 40 Port dimensions
- 41 Integral relief valve – SNM2IN
- 42 Anti-cavitation check valve – SNM2GN

- 42 Integral relief valve and Anti-cavitation check valve – SNM2JN
- 43 Outrigger bearing assembly – SNM2NN
- 47 Dimensions
  - 47 SNM2NN, SNU2NN – 01DA, 01FA and 01BA
  - 48 SNM2NN, SNU2NN – 02DB and 02AA
  - 49 SNM2NN, SNU2NN – 03CA
  - 50 SNM2NN, SNU2NN–04DB/05DB and 04AA/05AA
  - 51 SNM2NN, SNU2NN, SKU2NN – 06SA, 06GA

## Group 3 Gear Motors

- 52 Motor design
  - 52 SNM3NN
  - 52 SNU3NN
- 53 Technical data
- 54 Model code
- 59 Motor performance graphs
- 62 Flange, shaft and port configurations
- 63 Shaft and flange availability
- 64 Ports dimensions
- 67 Anti-cavitation check valve – SNM3GN
- 68 Dimensions
  - 68 SNM3NN, SNU3NN – 01FA, 01DA and 01BA
  - 69 SNM3NN, SNU3NN – 02FA, 02DB and 02AA
  - 70 SNM3NN, SNU3NN – 03FB and 03BB
  - 71 SNM3NN, SNU3NN – 06AA
  - 72 SNM3NN, SNU3NN – 07BC, 07SA and 07GA



## General information

### Overview

The Turolla Gear Motors is a range of peak performance fixed displacement hydraulic motors available in three different frame sizes: Group 1, Group 2 and Group 3, all as uni- and bidirectional version.

Constructed of a high strength extruded aluminum body with aluminum rear cover and aluminum front flange, all motors are balanced for exceptional efficiency and designed to ensure an excellent starting torque and, in the bidirectional version, to guarantee the ability to work with high back pressure and extremely low system pressure.

The flexibility of the range in each frame size combined with the high efficiency and low starting torque makes the Turolla Gear Motors ideal for a wide range of applications sectors including on- and off-highway hydraulic fan drive systems, turf care, road bidge, fork lifts and municipal.

All the unidirectional motors have the same construction of the correspondent pump as well but, with inlet and outlet positioned at the opposite side for the same rotation.

Some representatives of gear motors:

**SKM1NN 06SA**



**SNM3NN 01BA**

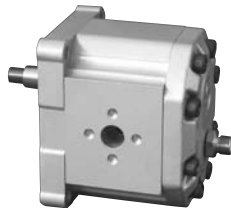

**SNM3NL 07SA**



**SNM2NN 9JDB**



**SNU2NN 06SA**

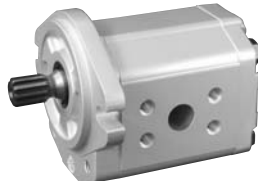

**SNU2NN 06GA**

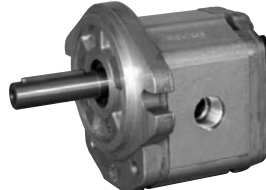

© 2013 Turolla™. All rights reserved.

Turolla accepts no responsibility for possible errors in catalogs, brochures and other printed material. Turolla reserves the right to alter its products without prior notice. This also applies to products already ordered provided that such alterations can be made without affecting agreed specifications. All trademarks in this material are properties of their respective owners. Danfoss, Turolla, Turolla OpenCircuitGear, OpenCircuitGear, Fast Lane and PLUS+1 are trademarks of the Danfoss Group.



**Features and Benefits**

- Three groups of frame sizes (Group 1, 2 and 3)
- Displacements from 2.6 to 90 cm<sup>3</sup>/rev [from 0.158 to 5.49 in<sup>3</sup>/rev]
- Available in uni- and bidirectional version for all the frame sizes, displacements and configurations
- Rated pressure up to 250 bar [3625 psi]
- Back pressure capability up to 250 bar [3625 psi]
- Speeds up to 4000 min<sup>-1</sup> (rpm) for Group 1 and 2, and up to 2500 min<sup>-1</sup> (rpm) for Group 3
- SAE, ISO and DIN mounting flanges and shafts
- Available with integrated relief valve in the Group 2 frame size and integrated anti-cavitation valve in Group 2 and Group 3 frame sizes.

**Motor Displacements**

Quick reference chart for unidirectional motor models (Group 1, 2 and 3)

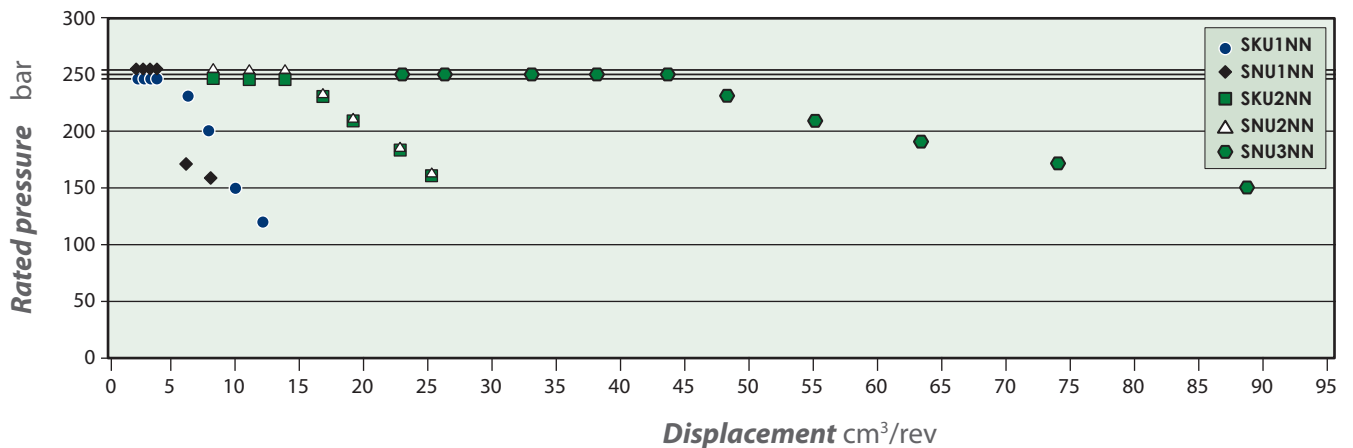

Quick reference chart for bidirectional motor models (Group 1, 2 and 3)

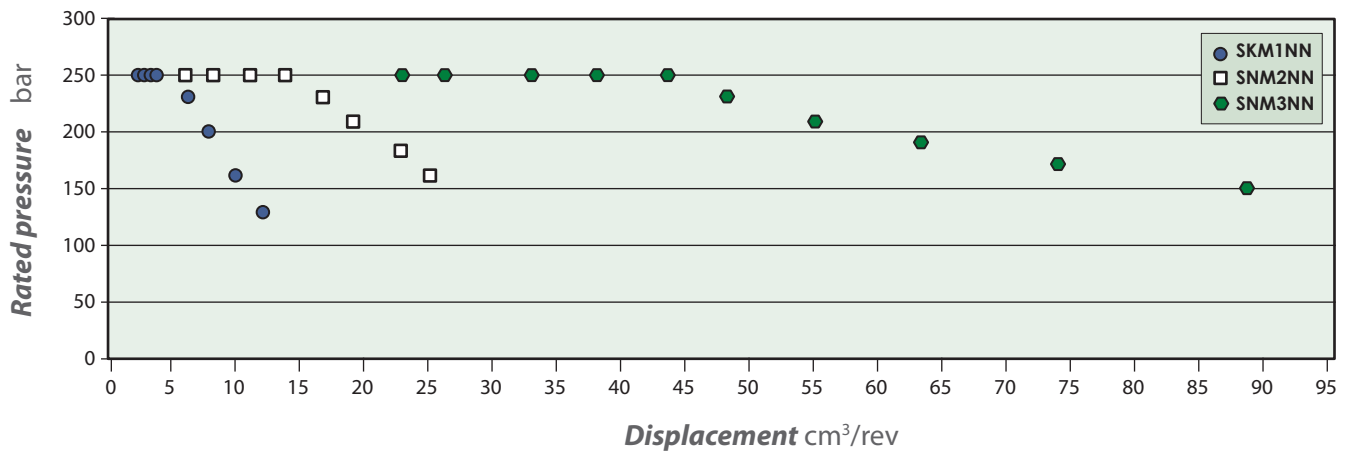



## Determination of Nominal Motor Size

Use these formulas to determine the nominal motor size for a specific application.

	Based on SI units	Based on US units
<b>Input flow:</b>	$Q = \frac{V_g \cdot n}{1000 \cdot \eta_v} \quad \text{l/min}$	$Q = \frac{V_g \cdot n}{231 \cdot \eta_v} \quad \text{[US gal/min]}$
<b>Output torque:</b>	$M = \frac{V_g \cdot \Delta p \cdot \eta_m}{20 \cdot \pi} \quad \text{N}\cdot\text{m}$	$M = \frac{V_g \cdot \Delta p \cdot \eta_m}{2 \cdot \pi} \quad \text{[lbf}\cdot\text{in]}$
<b>Output power:</b>	$P = \frac{M \cdot n}{9550} = \frac{Q \cdot \Delta p \cdot \eta_t}{600} \quad \text{kW}$	$P = \frac{M \cdot n}{63\,025} = \frac{Q \cdot \Delta p \cdot \eta_t}{1714} \quad \text{[hp]}$

### Variables

SI units [US units]

$V_g$	= Displacement per revolution	$\text{cm}^3/\text{rev}$ [ $\text{in}^3/\text{rev}$ ]
$p_o$	= Outlet pressure	bar [psi]
$p_i$	= Inlet pressure	bar [psi]
$\Delta p$	= $p_o - p_i$ (system pressure)	bar [psi]
$n$	= Speed	$\text{min}^{-1}$ (rpm)
$\eta_v$	= Volumetric efficiency	
$\eta_m$	= Mechanical efficiency	
$\eta_t$	= Overall efficiency ( $\eta_v \cdot \eta_m$ )	



## System Requirements

### Pressure

**Peak pressure** is the highest intermittent pressure allowed.

The relief valve overshoot (reaction time) determines peak pressure. It is assumed to occur for less than 100 ms.

The illustration to the right shows peak pressure in relation to rated pressure and reaction time (100 ms maximum).

**Rated pressure** is the average, regularly occurring operating inlet pressure that should yield satisfactory product life. The maximum machine load at the motor shaft determines rated pressure.

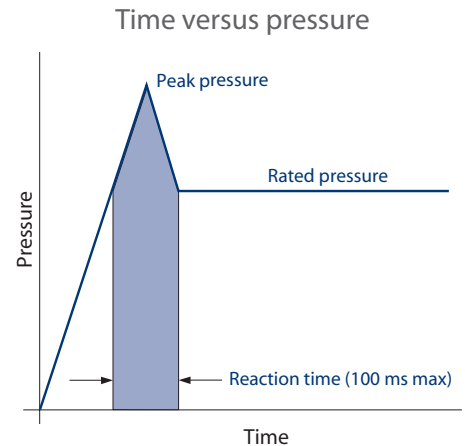

**System pressure** is the differential between the inlet and outlet ports. It is a dominant operating variable affecting hydraulic unit life. High system pressure, resulting from high load at the motor shaft, reduces expected life. System pressure must remain at, or below, rated pressure during normal operation to achieve expected life.

**Back pressure** is the average, regularly occurring operating outlet pressure that should yield satisfactory bidirectional motor life. The hydraulic load demand downstream of the motor determines the back pressure. Unidirectional motors cannot work with back pressure and the maximum back pressure allowed is 5 bar [72 psi] rated and 7 bar [101 psi] as peak.

**Case Drain Pressure** is the regularly occurring case drain line pressure that should yield satisfactory bidirectional motor life. It is recommended to design the case drain piping connecting the case drain direct to the tank in order to keep the case drain pressure as low as possible. The max. continuous case drain pressure allowed is 5 bar [72 psi] rated and 7 bar [101 psi] as peak.

### Speed

**Maximum speed** is the limit recommended by Turolla for a particular gear motor when operating at rated pressure. It is the highest speed at which normal life can be expected.

The lower limit of operating speed is the **minimum speed**. It is the lowest speed at which normal life can be expected.

The minimum speed increases as operating system pressure increases. When operating under higher pressures, a higher minimum speed must be maintained, as illustrated to the right.

Speed versus pressure

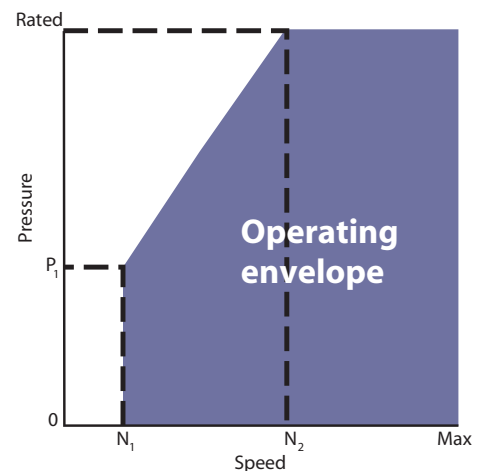

$N_1$  = minimum speed at low pressure  
 $N_2$  = minimum speed at rated pressure



## Hydraulic Fluids

Ratings and data for gear motors are based on operating with premium hydraulic fluids containing oxidation, rust, and foam inhibitors. These fluids must possess good thermal and hydrolytic stability to prevent wear, erosion, and corrosion of internal components. They include:

- Hydraulic fluids following DIN 51524, part 2 (HLP) and part 3 (HVLP) specifications
- API CD engine oils conforming to SAE J183
- M2C33F or G automatic transmission fluids
- Certain agricultural tractor fluids

Use only clean fluid in the motor and hydraulic circuit.

### ⚠ Caution

Never mix hydraulic fluids.

Please see Turolla publication [Hydraulic Fluids and Lubricants Technical Information, L1021414](#) for more information. Refer to publication [Experience with Biodegradable Hydraulic Fluids Technical Information, L1021903](#) for information relating to biodegradable fluids.

## Temperature and Viscosity

Temperature and viscosity requirements must be concurrently satisfied. Use petroleum/mineral-based fluids.

High temperature limits apply at the inlet port of the motor. The motor should run at or below the maximum continuous temperature. The peak temperature is based on material properties. Don't exceed it.

Cold oil, generally, doesn't affect the durability of motor components. It may affect the ability of oil to flow and transmit power. For this reason, keep the temperature at 16°C [60 °F] above the pour point of the hydraulic fluid.

Minimum (cold start) temperature relates to the physical properties of component materials.

**Minimum viscosity** occurs only during brief occasions of maximum ambient temperature and severe duty cycle operation. You will encounter maximum viscosity only at cold start. During this condition, limit speeds until the system warms up. Size heat exchangers to keep the fluid within these limits. Test regularly to verify that these temperatures and viscosity limits aren't exceeded. For maximum unit efficiency and bearing life, keep the fluid viscosity in the recommended viscosity range.

Fluid viscosity

<b>Maximum (cold start)</b>	mm <sup>2</sup> /s	1000 [4600]
<b>Recommended range</b>	[SUS]	12-60 [66-290]
<b>Minimum</b>		10 [60]

Temperature

<b>Minimum (cold start)</b>	°C [°F]	-20 [-4]
<b>Maximum continuous</b>		80 [176]
<b>Peak (intermittent)</b>		90 [194]





## Filtration

### Filters

Use a filter that conforms to Class 22/18/13 of ISO 4406 (or better). It may be on the motor outlet (discharge filtration) or inlet (pressure filtration).

### Selecting a filter

When selecting a filter, please consider:

- contaminant ingress rate (determined by factors such as the number of actuators used in the system)
- generation of contaminants in the system
- required fluid cleanliness
- desired maintenance interval
- filtration requirements of other system components

Measure filter efficiency with a Beta ratio ( $\beta_x$ ):

- for discharge filtration with controlled reservoir ingress, use a  $\beta_{35-45} = 75$  filter
- for pressure filtration, use a filtration with an efficiency of  $\beta_{10} = 75$

$\beta_x$  ratio is a measure of filter efficiency defined by ISO 4572. It is the ratio of the number of particles greater than a given diameter (" $x$ " in microns) upstream of the filter to the number of these particles downstream of the filter.

### Fluid cleanliness level and $\beta_x$ ratio

<b>Fluid cleanliness level (per ISO 4406)</b>	Class 22/18/13 or better
<b><math>\beta_x</math> ratio (discharge filtration)</b>	$\beta_{35-45} = 75$ and $\beta_{10} = 2$
<b><math>\beta_x</math> ratio (pressure filtration)</b>	$\beta_{10} = 75$
<b>Recommended inlet screen size</b>	100 – 125 $\mu\text{m}$ [0.0039 – 0.0049 in]

The filtration requirements for each system are unique. Evaluate filtration system capacity by monitoring and testing prototypes.

### Reservoir

The **reservoir** provides clean fluid, dissipates heat, removes entrained air, and allows for fluid volume changes associated with fluid expansion and during all system operating modes. A correctly sized reservoir accommodates maximum volume changes during all system operating modes. It promotes deaeration of the fluid as it passes through, and accommodates a fluid dwell-time between 60 and 180 seconds, allowing entrained air to escape.

**Minimum reservoir capacity** depends on the volume required to cool and hold the oil, allowing for expansion due to temperature changes. A fluid volume of one to three times the motor output flow (per minute) is satisfactory. The minimum reservoir capacity is 125% of the fluid volume.

Put the return-line below the lowest expected fluid level to allow discharge into the reservoir for maximum dwell and efficient deaeration. A baffle (or baffles) between the return and suction lines promotes deaeration and reduces fluid surges.



## Line Sizing

Choose pipe sizes that accommodate minimum fluid velocity to reduce system noise, pressure drops, and overheating. This maximizes system life and performance.

The line velocity should not exceed the values in this table:

Maximum line velocity

<b>Inlet</b>		2.5 [8.2]
<b>Outlet</b>	m/s [ft/sec]	5.0 [16.4]
<b>Return</b>		3.0 [9.8]

Most systems use hydraulic oil containing 10% dissolved air by volume. **Over-aeration** is the result of the flow-line restrictions. These include inadequate pipe sizes, sharp bends, or elbow fittings, causing a reduction of flow line cross sectional area. This problem will not occur if rated speed requirements are maintained, and reservoir size and location are adequate.

## Motor Shaft Connection

Shaft options for gear motors include tapered, splined, parallel or Turolla tang shafts.

**Plug-in drives**, with a splined shaft, can impose severe radial loads when the mating spline is rigidly supported. Increasing spline clearance does not alleviate this condition.

Use plug-in drives if the concentricity between the mating spline and pilot diameter is within 0.1 mm [0.004 in]. Lubricate the drive by flooding it with oil. A three-piece coupling minimizes radial or thrust shaft loads.

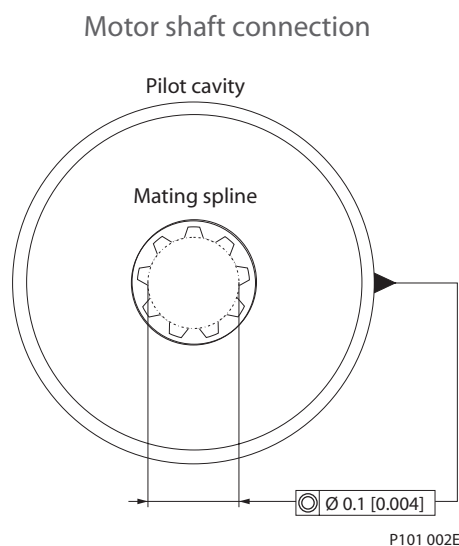

### ⚠ Caution

In order to avoid spline shaft damages it is recommended to use carburised and hardened steel couplings with 80-82 HRA surface hardness.

Allowable **radial shaft loads** are a function of the load position, load orientation, and operating pressure of the hydraulic motor. All external shaft loads have an effect on bearing life, and may affect motor performance.

In applications where external shaft loads can not be avoided, minimize the impact on the motor by optimizing the orientation and magnitude of the load. Avoid thrust loads in either direction. Please contact Turolla, if continuously applied external radial or thrust loads occur.



### Motor Shaft Load Data Form

Photocopy this page and fax the complete form to your Turolla representative for an assistance. This illustration shows a motor with counterclockwise orientation:

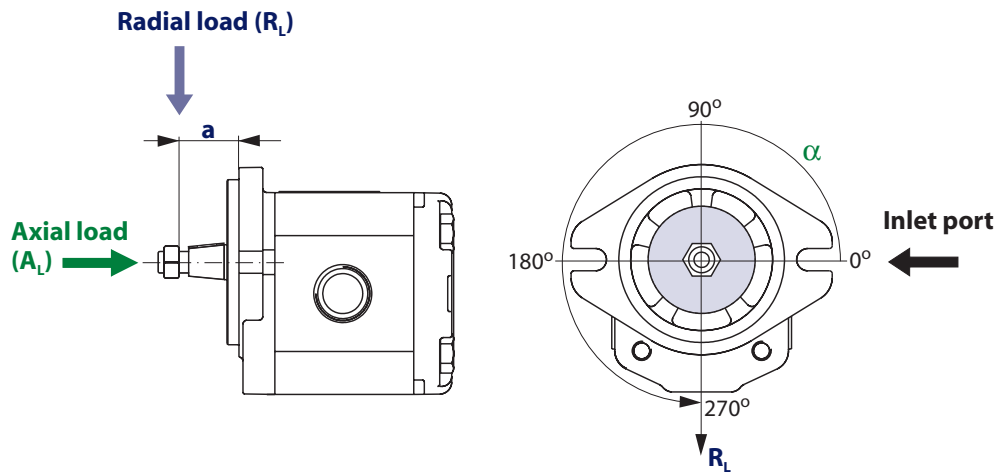

### Application data

Item	Value	Based on SI or US units	
Motor displacement		<input type="checkbox"/> cm <sup>3</sup> /rev	<input type="checkbox"/> in <sup>3</sup> /rev
Rated system pressure		<input type="checkbox"/> bar	<input type="checkbox"/> psi
Peak pressure			
Motor shaft rotation		<input type="checkbox"/> left	<input type="checkbox"/> right
Motor minimum speed		min <sup>-1</sup> (rpm)	
Motor maximum speed			
Radial load	$R_L$	<input type="checkbox"/> N	<input type="checkbox"/> lbf
Angular orientation of radial load to inlet port	$\alpha$	degree	
Axial load	$A_L$	<input type="checkbox"/> N	<input type="checkbox"/> lbf
Distance from flange to radial load	$a$	<input type="checkbox"/> mm	<input type="checkbox"/> in



## Motor Life

**Motor life** is a function of speed, system pressure, and other system parameters (such as fluid quality and cleanliness).

All Turolla gear motors use hydrodynamic journal bearings that have an oil film maintained between the gear/shaft and bearing surfaces at all times. If the oil film is sufficiently sustained through proper system maintenance and operating within recommended limits, long life can be expected.

---

**$B_{10}$  life expectancy number is generally associated with rolling element bearings. It does not exist for hydrodynamic bearings.**

---

High pressure impacts motor life. When submitting an application for review, provide machine duty cycle data that includes percentages of time at various loads and speeds. We strongly recommend a prototype testing program to verify operating parameters and their impact on life expectancy before finalizing any system design.



## GROUP 1 GEAR MOTORS

### Motor Design

#### SKM1NN

SKM1NN is the Group 1 bidirectional motor available in the whole displacements range from 2.6 up to 12 cm<sup>3</sup>/rev [from 0.158 up to 0.732 in<sup>3</sup>/rev].

Configurations include European and SAE flanges and shafts (Code 01BA, 01DA, 02BB, 02FA, 06GA, 06SA).

**SKM1NN 06SA**



#### SKU1NN

SKU1NN is a Group 1 unidirectional motor available in the whole displacements range from 2.6 up to 12 cm<sup>3</sup>/rev [from 0.158 up to 0.732 in<sup>3</sup>/rev]. The SKU1NN motor construction is derived from the correspondent pump SKP1NN.

Configurations include European and SAE flanges and shafts (Code 01BA, 01DA, 02BB, 02FA, 06GA, 06SA).

#### SNU1NN

SNU1NN is a Group 1 unidirectional motor available in a limited displacements range from 2.6 up to 7.8 cm<sup>3</sup>/rev [from 0.158 up to 0.464 in<sup>3</sup>/rev]. The SNU1NN motor construction is derived from the correspondent pump SNP1NN.

Configurations include European flange and shaft (Code 01BA).

**SNU1NN 01BA (cut-away)**

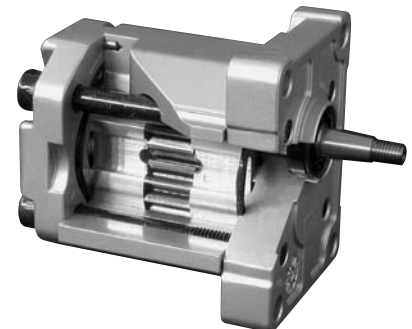



## Technical Data

Technical data for Group 1 gear motors

		Frame size							
		2,6	3,2	3,8	4,3	6,0	7,8	010	012
Displacement	cm <sup>3</sup> /rev [in <sup>3</sup> /rev]	2.62 [0.158]	3.14 [0.195]	3.66 [0.231]	4.19 [0.262]	5.89 [0.366]	7.59 [0.463]	9.94 [0.607]	12 [0.732]
<b>SKM1NN (a standard, bidirectional motor)</b>									
Peak pressure	bar [psi]	270 [3915]	270 [3915]	270 [3915]	270 [3915]	250 [3625]	220 [3190]	180 [2610]	150 [2175]
Rated pressure		250 [3625]	250 [3625]	250 [3625]	250 [3625]	230 [3335]	200 [2900]	160 [2320]	130 [1895]
Back pressure		250 [3625]	250 [3625]	250 [3625]	250 [3625]	230 [3335]	200 [2900]	160 [2320]	130 [1895]
Minimum speed	min <sup>-1</sup>	1000	1000	1000	800	800	800	800	800
Maximum speed	(rpm)	4000	4000	3000	3000	2000	2000	2000	2000
<b>SKU1NN (a standard, unidirectional motor)</b>									
Peak pressure	bar [psi]	270 [3915]	270 [3915]	270 [3915]	270 [3915]	250 [3625]	220 [3190]	170 [2465]	140 [2030]
Rated pressure		250 [3625]	250 [3625]	250 [3625]	250 [3625]	230 [3335]	200 [2900]	150 [2175]	120 [1740]
Minimum speed	min <sup>-1</sup>	1000	1000	1000	800	800	800	800	800
Maximum speed	(rpm)	4000	4000	3000	3000	2000	2000	2000	2000
<b>SNU1NN (a standard, unidirectional motor)</b>									
Peak pressure	bar [psi]	270 [3915]	270 [3915]	270 [3915]	270 [3915]	190 [2755]	180 [2610]	-	
Rated pressure		250 [3625]	250 [3625]	250 [3625]	250 [3625]	170 [2465]	160 [2320]		
Minimum speed	min <sup>-1</sup>	1000	1000	1000	800	800	800		
Maximum speed	(rpm)	4000	4000	3000	3000	2000	2000		
<b>All</b>									
Weight	kg [lb]	1.02 [2.26]	1.14 [2.51]	1.18 [2.60]	1.20 [2.65]	1.30 [2.87]	1.39 [3.06]	1.55 [3.42]	1.65 [3.64]
Moment of inertia of rotating components	x 10 <sup>-6</sup> kg·m <sup>2</sup> [x 10 <sup>-6</sup> lbf·ft <sup>2</sup> ]	5.1 [121.0]	5.7 [135.2]	6.4 [151.9]	7.1 [168.5]	9.3 [220.7]	11.4 [270.5]	14.6 [339.4]	17.1 [405.8]

1 kg·m<sup>2</sup> = 23.68 lb·ft<sup>2</sup>

### ! Caution

The rated and peak pressure mentioned are for motors with flanged ports only. When threaded ports are required a derated performance has to be considered. To verify the compliance of an high pressure application with a threaded ports pump apply to a Turolla representative.



## Product Code

## Model Code

A	B	C	D	E	F	G	H	I	J	K	L	M	N	O
<input type="text"/>	<input type="text"/>	<input type="text"/>	<input type="text"/>	<input type="text"/>	<input type="text"/>	<input type="text"/>	<input type="text"/>	<input type="text"/>	<input type="text"/>	<input type="text"/>	<input type="text"/>	<input type="text"/>	<input type="text"/>	<input type="text"/>

### A Family

<b>SNU1NN</b>	Unidirectional gear motor
<b>SKU1NN</b>	High torque unidirectional gear motor
<b>SKM1NN</b>	Standard bidirectional gear motor
<b>SKM1IN</b>	Bidirectional motor with relief valve
<b>SKM1WL</b>	Bidirectional motor+Relief valve;Anti-shock valve;Radial drain

### B Displacement

<b>2,6</b>	2.62 cc
<b>3,2</b>	3.14 cc
<b>3,8</b>	3.66 cc
<b>4,3</b>	4.19 cc
<b>5,5</b>	5.23 cc
<b>6,0</b>	5.89 cc
<b>7,8</b>	7.59 cc
<b>010</b>	9.94 cc
<b>012</b>	12.0 cc

### C Rotation

<b>L</b>	Left hand
<b>R</b>	Right hand
<b>B</b>	Bidirectional

### D Project version (value representing a change to the initial project)

<b>N</b>	Std Version of Project
<b>6</b>	Short version -Special

### E Mounting flange

<b>01</b>	European 4 bolt flange with pilot Ø25,4 mm
<b>02</b>	European 4 bolt flange with pilot Ø30 mm
<b>06</b>	SAE A-A 2 bolt flange with pilot Ø50,8 mm
<b>**</b>	SAE A pilot Ø82,55+2 holes (**Special Option)



A	B	C	D	E	F	G	H	I	J	K	L	M	N	O
<input type="checkbox"/>	<input type="checkbox"/>	<input type="checkbox"/>	<input type="checkbox"/>	<input type="checkbox"/>	<input checked="" type="checkbox"/>	<input checked="" type="checkbox"/>	<input type="checkbox"/>	<input type="checkbox"/>	<input type="checkbox"/>	<input type="checkbox"/>	<input type="checkbox"/>	<input type="checkbox"/>	<input type="checkbox"/>	<input type="checkbox"/>

## F Drive gear

<b>BA</b>	Taper 1:8-M7-Key2,41 SKP1
<b>BB</b>	Taper 1:8-M10x1-Key 3
<b>DB</b>	Splined Z15-m0,75-alfa 30°-L14-Dr60,5
<b>DC</b>	Splined B12x9-L14-flange protrusion sb22-Z6-m1,60-alfa 30°
<b>FA</b>	Parallel Ø12-Thread M10x1-Key 3
<b>GA</b>	Parallel Ø12,7-Key 3,2
<b>SA</b>	SAE spline J498-9T-20/40 Flat Root Side FIT-L15
<b>SG</b>	SAE spline J498-8T-16/32 -shaft version 6

## G Rear cover

<b>P1</b>	Standard cover for unidirectional motors
<b>M1</b>	Standard cover for motors drain M12x1,5
<b>M2</b>	Cover with drain 1/8" Gas
<b>M3</b>	Cover with drain 1/4" Gas
<b>M6</b>	Cover with drain 7/16-20UNF-2B
<b>MH</b>	Cover with drain M12x1,5 ISO6149
<b>I1</b>	Cover for unidirectional motors with relief valve
<b>L6</b>	Cover motor with side drain in vertical axis 7/16-20UNF-2B
<b>V1</b>	Cover for bidirectional motors with relief valve with drain 1/4 Gas
<b>W6</b>	Cover motor with relief and antishock valve



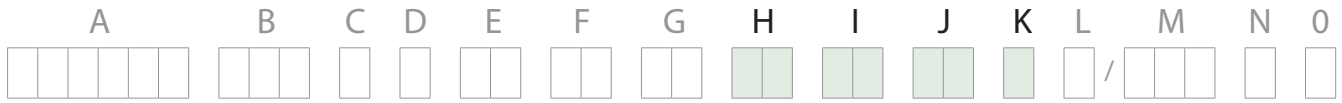

**H Inlet size**    **I Outlet size**

<b>B1</b>	8x30xM6	
<b>B2</b>	13x30xM6	
<b>C1</b>	8x26xM5	
<b>C2</b>	12x26xM5	
<b>C3</b>	13,5x30xM6	
<b>D3</b>	M14x1,5	
<b>D5</b>	M18x1,5	
<b>D7</b>	M22x1,5	

<b>E3</b>	9/16-18UNF	
<b>E4</b>	3/4-16UNF	
<b>E5</b>	7/8-14UNF	
<b>F2</b>	1/4 GAS	
<b>F3</b>	3/8 GAS	
<b>F4</b>	1/2 GAS	
<b>H2</b>	10xM12x1,5-ISO6149	
<b>H4</b>	12xM16x1,5-ISO6149	
<b>H5</b>	12xM18x1,5-ISO6149	
<b>H7</b>	13,5xM22x1,5-ISO6149	

**J Ports Pos & Spec Body**

<b>N</b>	Std from catalogue
----------	--------------------

**K Seals**

<b>N</b>	Standard NBR seal
<b>H</b>	VITON seals + special backing ring-special for SKU1NN



## L Screws

N	Std screws
B	GEOMET screws

## M Set valves

NNN	No valve
V**	Integral relief valve pressure setting

\*\*For details go to page 23

## N Type of mark

N	Standard Turolla Marking
A	Standard Turolla Marking+Customer Code
Z	Without Marking

## O Mark position

N	Std Marking position (on top)
A	Special Marking position on the bottom



### Motor performance graphs

The graphs on the next pages provide typical inlet flow and output power for Group 1 motors at various working pressures. Data were taken using ISO VG46 petroleum /mineral based fluid at 50 °C [122 °F] (viscosity = 28 mm<sup>2</sup>/s [132 SUS]).

SKM1NN/2,6 motor performance graph

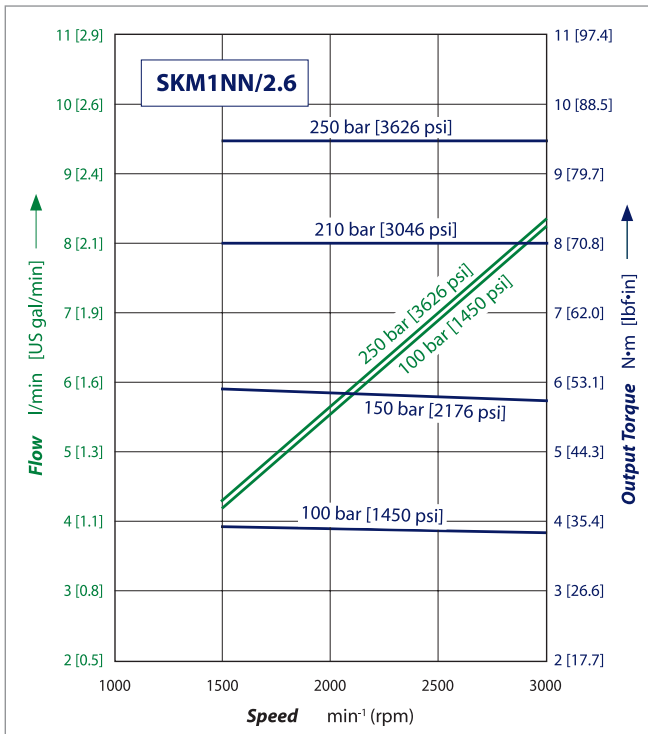

SKM1NN/3,2 motor performance graph

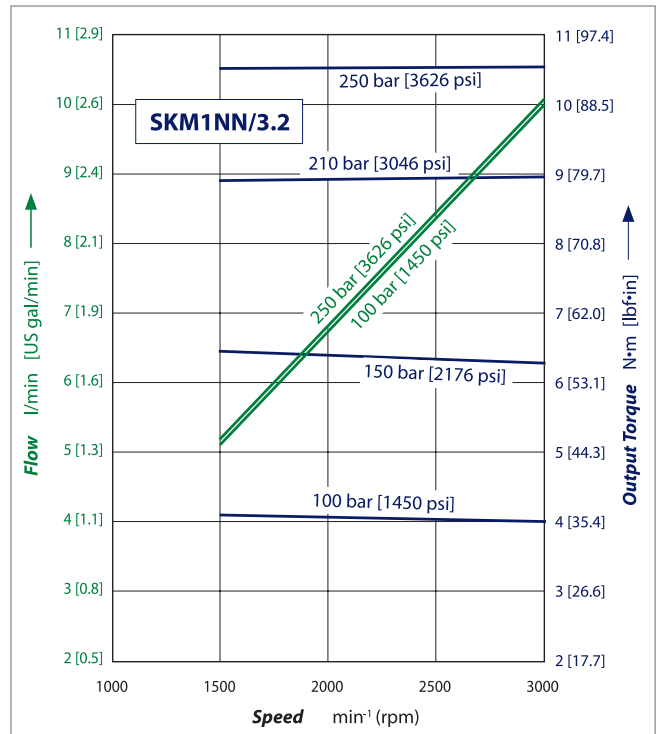

SKM1NN/3,8 motor performance graph

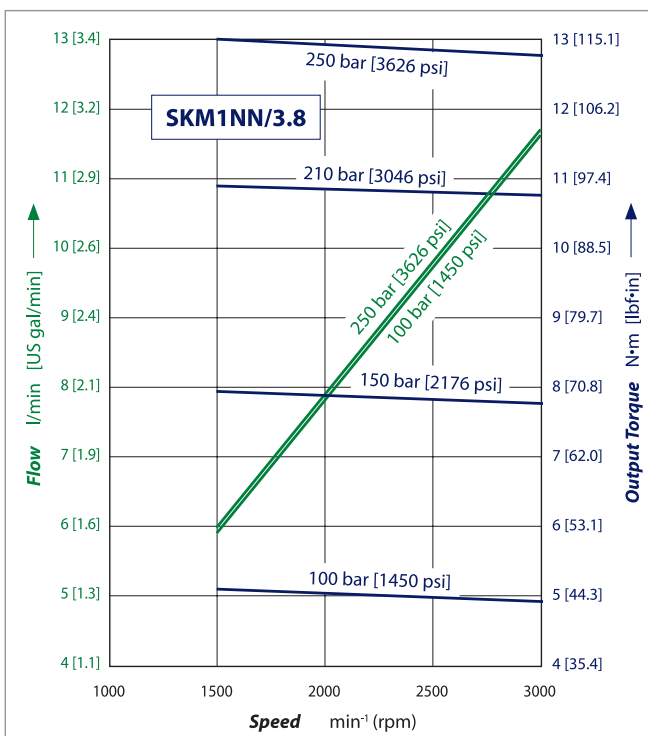

SKM1NN/4,3 motor performance graph

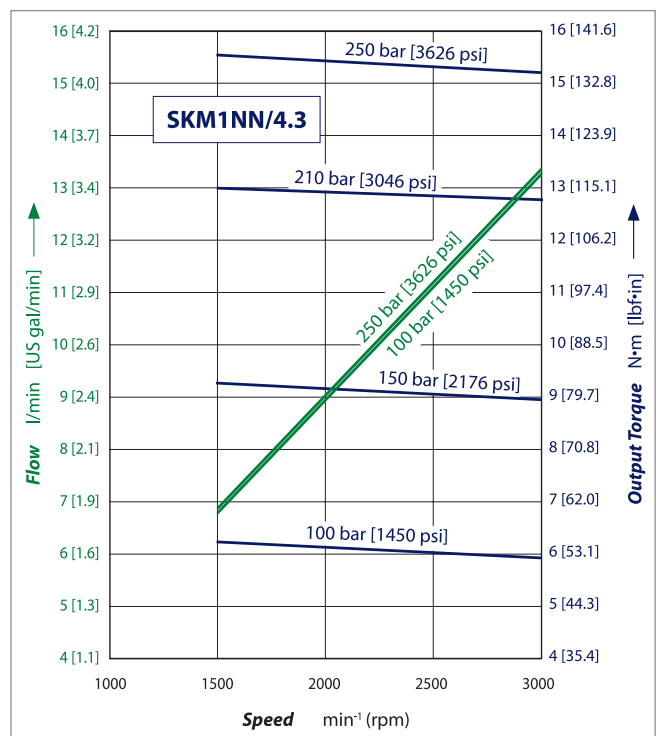



SKM1NN/6,0 motor performance graph

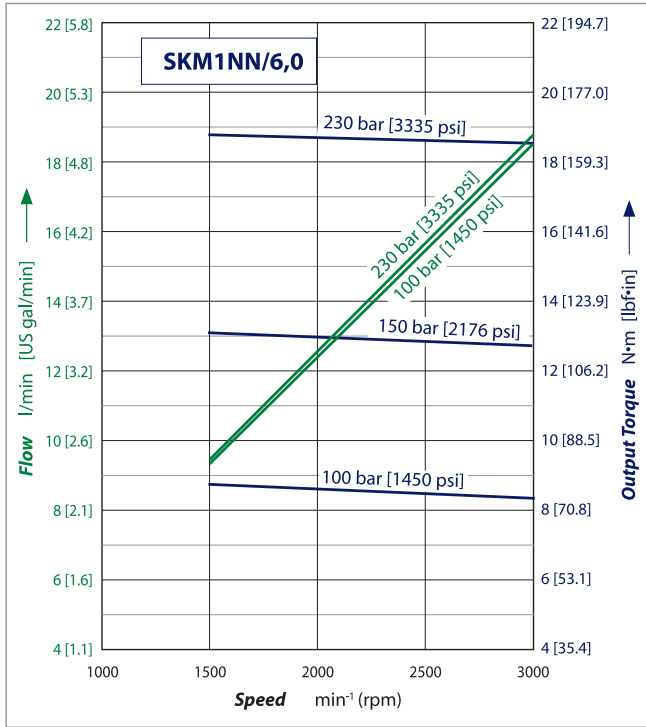

SKM1NN/7,8 motor performance graph

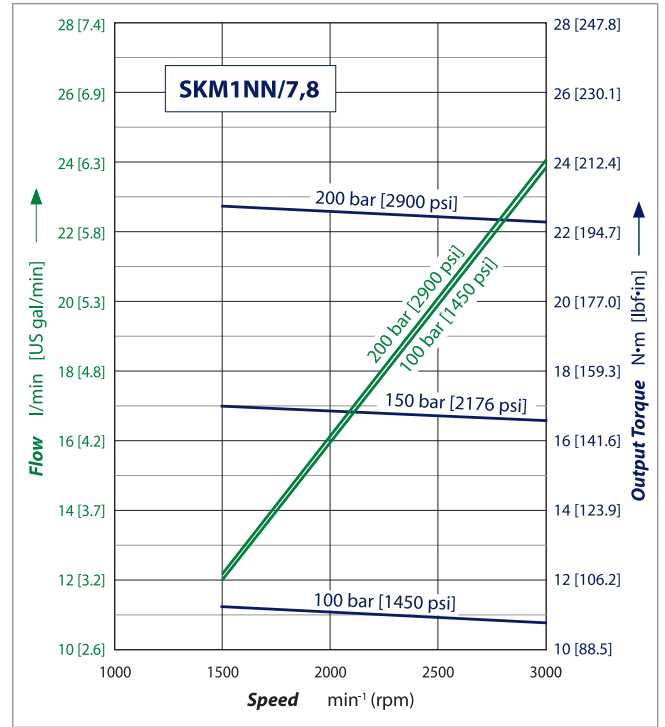

SKM1NN/010 motor performance graph

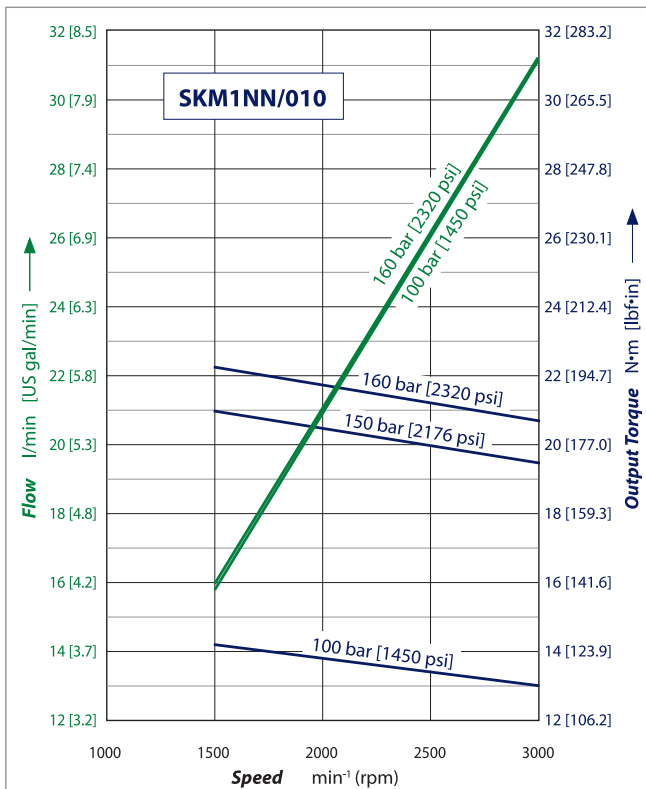



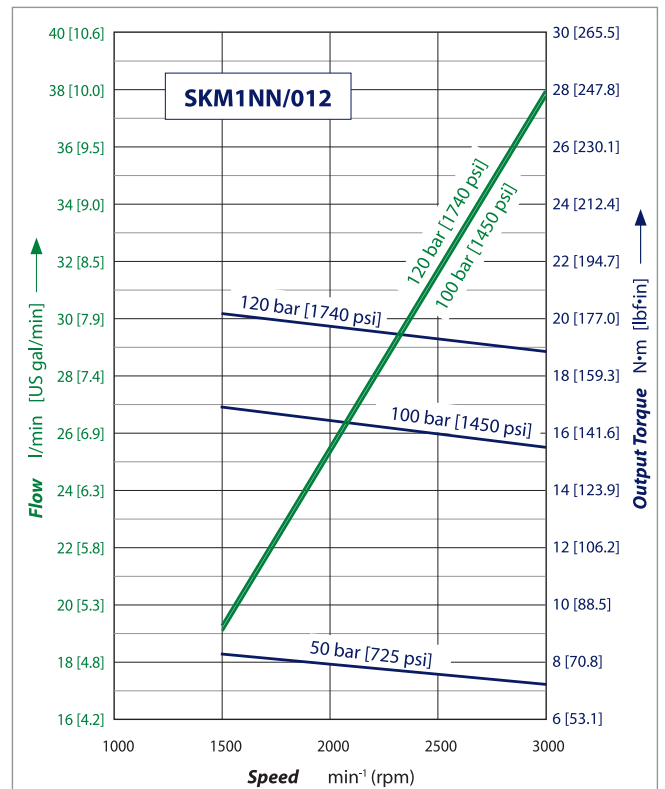

SKM1NN/012 motor performance graph



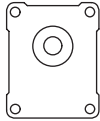
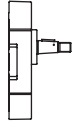
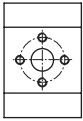
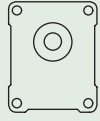
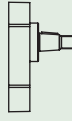
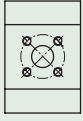
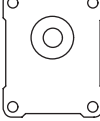
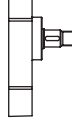
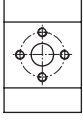
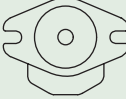

## Flange, shaft and port configurations

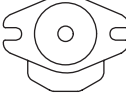
Flange, shaft and port configurations for SKM1NN and SKU1NN motors

Code	Flange	Shaft	Port
<b>01BA</b>	European 01, 4-bolts pilot Ø 25.4 mm [1.0 in] 	Taper 1:8 	European in <b>+</b> pattern 
<b>02BB</b>	European 02, 4-bolts pilot Ø 30 mm [1.181] 	Taper 1:8 	German standard in <b>X</b> pattern 
<b>02FA</b>	European 02, 4-bolts pilot Ø 30 mm [1.181] 	Parallel 12 mm [0.472 in] 	European in <b>+</b> pattern 
<b>06GA</b>	SAE A-A 2-bolts 	Parallel 12.7 mm [0.5 in] 	Threaded SAE O-ring boss 
<b>06SA</b>	SAE A-A 2-bolts 	SAE A-A 9-teeth splined 	Threaded SAE O-ring boss 

Flange, shaft and port configuration for SNU1NN motor

Code	Flange	Shaft	Port
<b>01BA</b>	European 01, 4-bolts pilot Ø 25.4 mm [1.0 in] 	Taper 1:8 	European in <b>+</b> pattern 



## Shaft options

Group 1 motors are available with a variety of splined, parallel, and tapered shaft ends. Not all shaft styles are available with all flange styles.

Shaft availability and nominal torque capability



Shaft		Mounting flange code with maximum torque		
Code	Description	01	02	06
<b>BA</b>	Taper 1:8	25 [221]	-	-
<b>BB</b>	Taper 1:8	-	50 [442]	-
<b>DB</b>	Splined Z15-m0,75-alfa 30°-L14	-	35 [309]	-
<b>DC</b>	Splined B12x9-L14-Z6-m1,60	30 [265]	-	-
<b>FA</b>	Parallel 12 mm [0.47 in]	-	24 [212]	-
<b>GA</b>	Parallel 12.7 mm [0.50 in]	-	-	32 [283]
<b>SA</b>	SAE spline J 498-9T-20/40DP	-	-	34 [301]
<b>SG</b>	SAE spline J498-8T-16/32 (version 6 only)	-	-	34 [301]

Recommended mating splines for Group 1 splined output shafts should be in accordance with SAE J498 or DIN 5482. Turolla external SAE splines are flat root side fit with circular tooth thickness reduced by 0.127 mm [0.005 in] in respect to class 1 fit. The external DIN splines have an offset increased by 0.1 mm [0.004 in]. These dimensions are modified in order to assure a clearance fit with the mating spline.

Other shaft options may exist. Contact your Turolla representative for availability.

### ⚠ Caution

Shaft torque capability may limit allowable pressure. Torque ratings assume no external radial loading. Applied torque must not exceed these limits, regardless of stated pressure parameters. Maximum torque ratings are based on shaft torsional fatigue strength.



### Integral relief valve – SKM1IN

Turolla offers an optional **integral relief valve** integrated in the Group 1 motors rear cover. It is drained internally and directs all the flow from the motor inlet to the outlet when the inlet pressure reaches the valve setting.

The tables below show applicable variant codes for ordering motors with integral relief valve. Refer to **Model Code**, page 18 for more information.

Valve schematic diagram

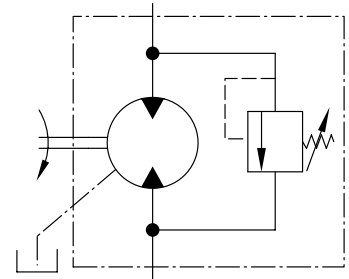

Integral relief valve rear cover cross section

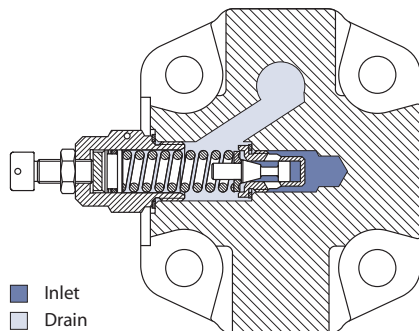

Pressure vs flow

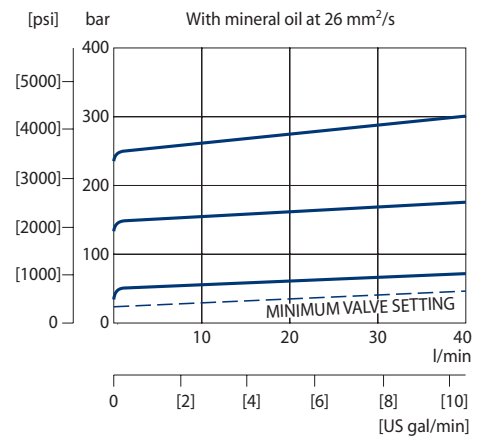

### Variant codes for ordering integral relief valve



M Variant code (left part)

Code	Motor speed for RV setting min <sup>-1</sup> (rpm)
A	not defined
C	500
E	1000
F	1250
G	1500
K	2000
I	2250
L	2500
M	2800
N	3000
O	3250

M Variant code (right part)

Code	Pressure setting bar [psi]
A	no setting
B	no valve
C	18 [261]
D	25 [363]
E	30 [435]
F	35 [508]
G	40 [580]
J	150 [2175]
K	50 [725]
L	60 [870]
M	70 [1015]
N	80 [1160]

Code	Pressure setting bar [psi]
O	90 [1305]
P	100 [1450]
Q	110 [1595]
R	120 [1740]
S	130 [1885]
T	140 [2030]
U	160 [2321]
V	170 [2466]
W	180 [2611]
X	210 [3046]
Z	250 [3626]



## Ports dimensions

Available ports for Group 1 motors

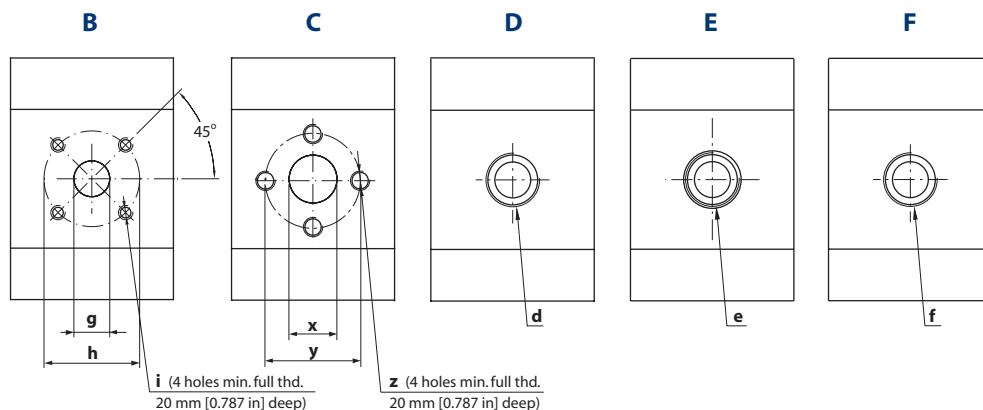

## Bidirectional motor ports

SKM1NN bidirectional motor ports dimensions (all frame sizes)

Port type	B			C			D	E	F
Port dimensions	g	h	i	x	y	z	d	e	f
Inlet/Outlet	13 [0.512]	30 [1.181]	M6	12 [0.472]	26 [1.024]	M5	M18x1.5	3/4-16UNF-2B	3/8 Gas (BSPP)
Drain	M12x1.5			M12x1.5			M12x1.5	7/16-20UNF-2B	1/8 Gas (BSPP)

## Unidirectional motor ports

SNU1NN, SKU1NN unidirectional motor ports dimensions

Port type	B			C			D	E	F		
Port dimensions	g	h	i	x	y	z	d	e	f		
Frame size	2,6	Inlet	8 [0.315]	30 [1.181]	M6	12 [0.472]	26 [1.024]	M5	M14x1.5	1/16-18UNF-2B	3/8 Gas (BSPP)
		Outlet	13 [0.512]						M18x1.5	3/4-16UNF-2B	
	3,2	Inlet	8 [0.315]						M14x1.5	1/16-18UNF-2B	
		Outlet	13 [0.512]						M18x1.5	3/4-16UNF-2B	
	3,8	Inlet	8 [0.315]						M14x1.5	1/16-18UNF-2B	
		Outlet	13 [0.512]						M18x1.5	3/4-16UNF-2B	
	4,3	Inlet	8 [0.315]						M14x1.5	1/16-18UNF-2B	
		Outlet	13 [0.512]						M18x1.5	3/4-16UNF-2B	
	6,0	Inlet	13 [0.512]						M18x1.5	1/16-18UNF-2B	
		Outlet	13 [0.512]						M18x1.5	3/4-16UNF-2B	
	7,8	Inlet	13 [0.512]						M18x1.5	1/16-18UNF-2B	
		Outlet	13 [0.512]						M18x1.5	3/4-16UNF-2B	
	010	Inlet	13 [0.512]						M18x1.5	1/16-18UNF-2B	
		Outlet	13 [0.512]						M18x1.5	3/4-16UNF-2B	
	012	Inlet	13 [0.512]						M18x1.5	1/16-18UNF-2B	
		Outlet	13 [0.512]						M18x1.5	3/4-16UNF-2B	





# Dimensions

## SKM1NN, SKU1NN, SNU1NN – 01BA

Standard porting drawing for 01BA

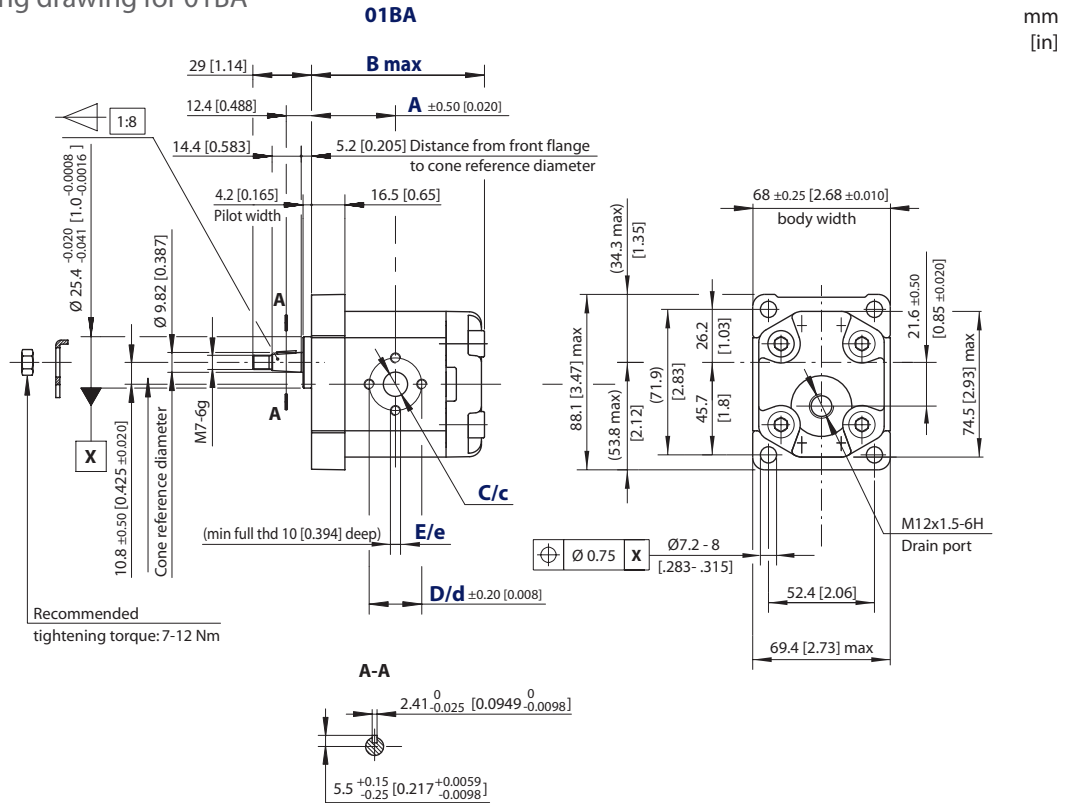

For unidirectional motors no case drain hole into the rear cover.

### SKM1NN – 01BA dimensions

Type (displacement)	2,6	3,2	3,8	4,3	6,0	7,8	010	012	
Dimension	A	40.5 [1.594]	41.5 [1.634]	42.5 [1.673]	43.5 [1.713]	46.75 [1.841]	50.0 [1.969]	54.5 [2.146]	58.5 [2.303]
	B	85.0 [3.346]	87.0 [3.425]	89.0 [3.504]	91.0 [3.583]	97.5 [3.839]	104.0 [4.094]	113.0 [4.449]	121.0 [4.764]
Inlet/Outlet	C/c	12 [0.472]							
	D/d	26 [1.024]							
	E/e	M5							

For unidirectional SNU1NN, SKU1NN dimensions, see [Ports dimensions](#), page 24.

### Model code examples and maximum shaft torque

Flange/drive gear	Model code example	Maximum shaft torque
01BA	SKM1NN/3,2BN01BAM1C2C2NNNN/NNNNN SKU1NN/4,3LN01BAP1C2C2NNNN/NNNNN SNU1NN/3,8RN01BAP1F3F3NNNN/NNNNN	25 N·m [221 lb·in]

For further details on ordering, see [Model Code](#), pages 15-18.



**SKM1NN, SKU1NN – 02BB, 02FA**  
Standard porting drawing for 02BB and 02FA

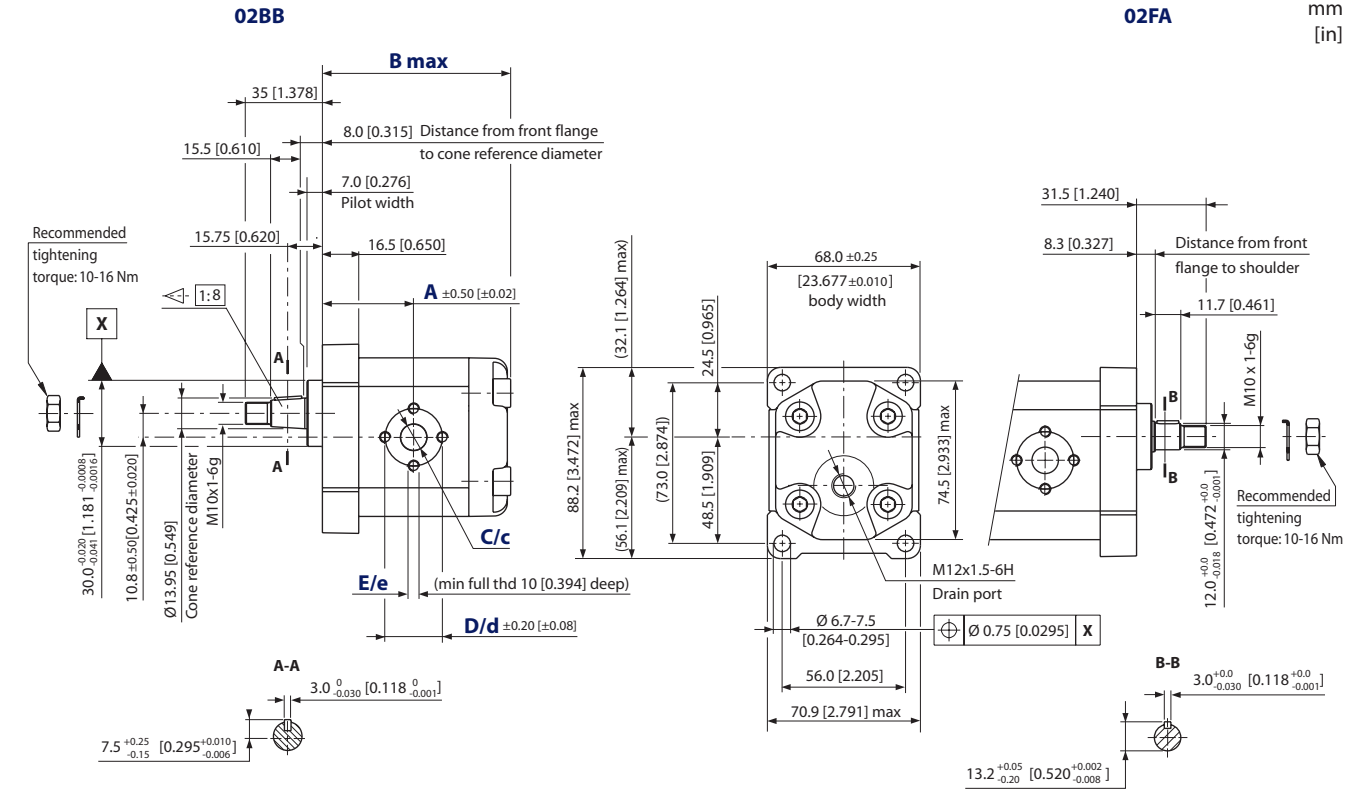

For unidirectional motors no case drain hole into the rear cover.

SKM1NN – 02BB and 02FA dimensions

Type (displacement)	2,6	3,2	3,8	4,3	6,0	7,8	010	012	
Dimension	A	40.5 [1.594]	41.5 [1.634]	42.5 [1.673]	43.5 [1.713]	46.75 [1.841]	50.0 [1.969]	54.5 [2.146]	58.5 [2.303]
	B	85.0 [3.346]	87.0 [3.425]	89.0 [3.504]	91.0 [3.583]	97.5 [3.839]	104.0 [4.094]	113.0 [4.449]	121.0 [4.764]
Inlet/Outlet	C/c	12 [0.472]							
	D/d	26 [1.024]							
	E/e	M5							

For unidirectional SKU1NN dimensions, see [Ports dimensions](#), page 24.

Model code examples and maximum shaft torque

Flange/drive gear	Model code example	Maximum shaft torque
02BB	SKM1NN/010BN02BBM1C2C2NNNN/NNNNN SKU1NN/6,0LN02BBM1C2C2NNNN/NNNNN	50 N·m [442 lb·in]
02FA	SKM1NN/6,0BN02FAM1C2C2NNNN/NNNNN SKU1NN/6,0LN02FAM1C2C2NNNN/NNNNN	24 N·m [212 lb·in]

For further details on ordering, see [Model Code](#), pages 15-18.



**SKM1NN, SKU1NN – 06GA and 06SA**  
Standard porting drawing for 06GA and 06SA

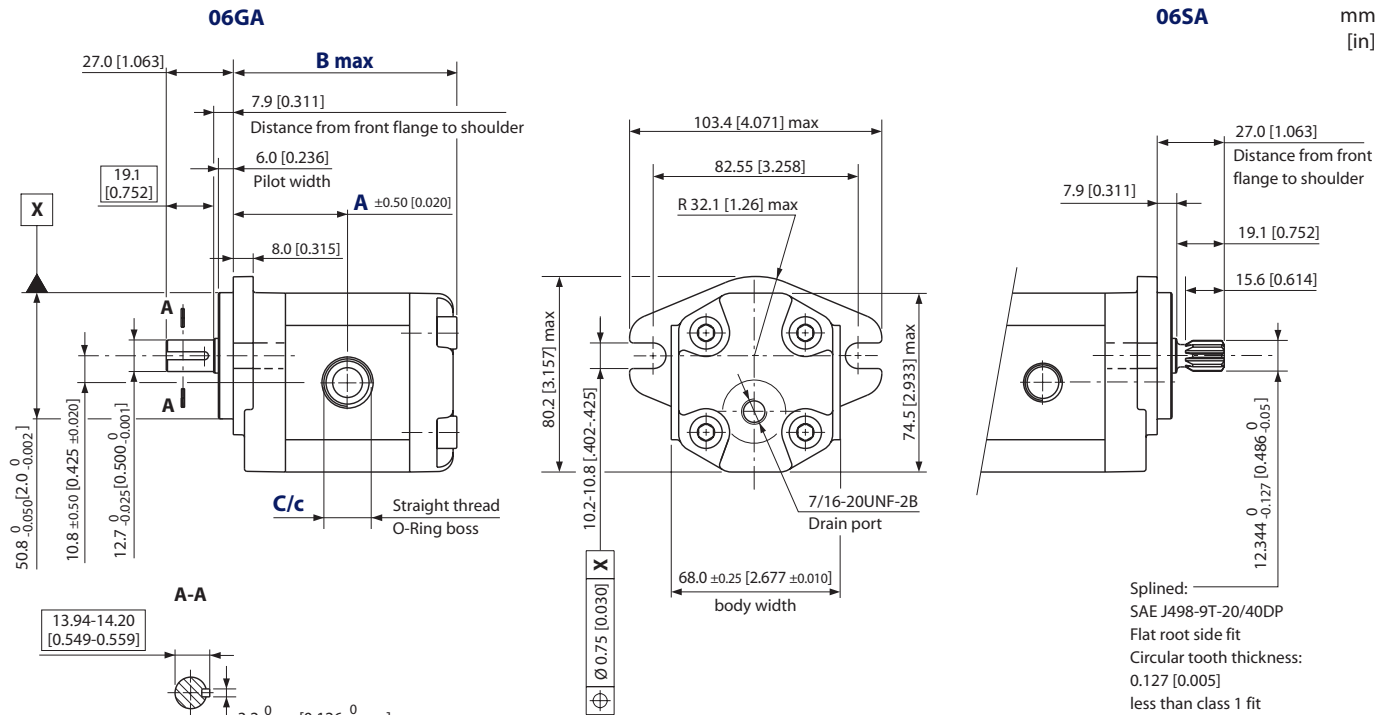

For unidirectional motors no case drain hole into the rear cover.

SKM1NN – 06GA and 06SA dimensions

Type (displacement)	2,6	3,2	3,8	4,3	6,0	7,8	010	012	
Dimension	A	45 [1.771]	46 [1.811]	47 [1.850]	48 [1.889]	51.25 [2.017]	54.5 [2.145]	59 [2.322]	63.5 [2.500]
	B	89.5 [3.523]	91.5 [3.602]	93.5 [3.681]	95.5 [3.759]	102 [4.015]	108.5 [4.271]	117.5 [4.625]	125.5 [4.940]
Inlet/Outlet	C/c 3/4-16UNF-2B, THD 14.3 [0.563] deep								

For unidirectional SKU1NN dimensions, see [Ports dimensions](#), page 24.

Model code examples and maximum shaft torque

Flange/drive gear	Model code example	Maximum shaft torque
06GA	SKM1NN/6,0BN06GAM6E4ENNNN/NNNNN SKU1NN/4,3RN06GAP1E3E4NNNN/NNNNN	32 N·m [283 lb·in]
06SA	SKM1NN/012BN06SAM6E4ENNNN/NNNNN SKU1NN/3,2LN06SAP1E3E4NNNN/NNNNN	34 N·m [301 lb·in]

For further details on ordering, see [Model Code](#), pages 15-18.



## GROUP 2 GEAR MOTORS

### Motor Design

#### SNM2NN

SNM2NN is the group 2 bidirectional motor available in the whole displacements range from 6 up to 25 cm<sup>3</sup>/rev [from 0.37 up to 1.538 in<sup>3</sup>/rev].

Configurations include European and SAE flanges and shafts (Code 01BA, 01FA, 01DA, 02AA, 02DB, 03CA, 04AA/05AA, 04DB/05DB, 06GA, 06SA).

#### SNU2NN

SNU2NN is the group 2 unidirectional motor available in the displacements range from 8 up to 25 cm<sup>3</sup>/rev [from 0.513 up to 1.538 in<sup>3</sup>/rev]. The SNU2NN motor construction is derived from the correspondent pump SNP2NN.

Configurations include European and SAE flanges and shafts (Code 01BA, 01FA, 01DA, 02AA, 02DB, 03CA, 04AA/05AA, 04DB/05DB, 06GA, 06SA).

#### SKU2NN

SKU2NN is the Group 2 unidirectional motor available in the displacements range from 8 up to 25 cm<sup>3</sup>/rev [from 0.513 up to 1.538 in<sup>3</sup>/rev]. The SKU2NN motor construction is derived from the correspondent pump SKP2NN. Configuration includes SAE flange and shaft only (Code 06SA).

SNM2NN 9JDB (cut-away)

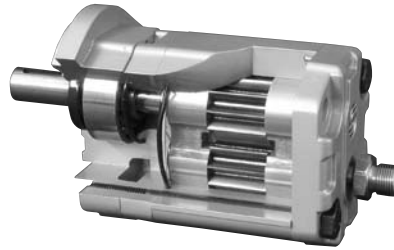

SNU2NN 06SA (cut away)

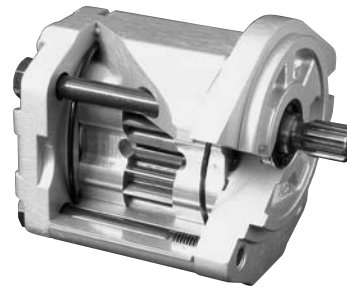



## Technical data

The table below details the technical data for Group 2 gear motors based on the model and displacement configuration.

Technical data for Group 2 gear motors

		Frame size							
		6,0*	8,0	011	014	017	019	022	025
Displacement	cm <sup>3</sup> /rev [in <sup>3</sup> /rev]	6.0 [0.36]	8.4 [0.513]	10.8 [0.659]	14.4 [0.879]	16.8 [1.025]	19.2 [1.171]	22.8 [1.391]	25.2 [1.538]
<b>SNM2NN (bidirectional motor)</b>									
Peak pressure	bar [psi]	280 [4060]	280 [4060]	280 [4060]	280 [4060]	260 [3770]	230 [3335]	200 [2900]	180 [2610]
Rated pressure		250 [3625]	250 [3625]	250 [3625]	250 [3625]	230 [3335]	210 [3045]	180 [2610]	160 [2320]
Outlet back pressure		250 [3625]	250 [3625]	250 [3625]	250 [3625]	230 [3335]	210 [3045]	180 [2610]	160 [2320]
Minimum speed	min <sup>-1</sup> (rpm)	700	700	700	700	500	500	500	500
Maximum speed		4000	4000	4000	4000	4000	3500	3500	3500
<b>SNU2NN (unidirectional motor)</b>									
Peak pressure	bar [psi]	-	280 [4060]	280 [4060]	280 [4060]	260 [3770]	230 [3335]	200 [2900]	180 [2610]
Rated pressure			250 [3625]	250 [3625]	250 [3625]	230 [3335]	210 [3045]	180 [2610]	160 [2320]
Minimum speed	min <sup>-1</sup> (rpm)		600	600	600	500	500	500	500
Maximum speed			3500	3500	3500	3000	3000	3000	2500
<b>SKU2NN (unidirectional motor)</b>									
Peak pressure	bar [psi]	-	280 [4060]	280 [4060]	280 [4060]	260 [3770]	230 [3335]	200 [2900]	175 [2815]
Rated pressure			250 [3625]	250 [3625]	250 [3625]	230 [3335]	210 [3045]	180 [2610]	160 [2320]
Minimum speed	min <sup>-1</sup> (rpm)		600	600	600	500	500	500	500
Maximum speed			3500	3500	3500	3000	3000	3000	2500
<b>All (SNM2NN, SNU2NN, SKU2NN)</b>									
Weight	kg [lb]	2.4 [5.3]	2.5 [5.5]	2.7 [5.5]	2.9 [6.3]	3.0 [6.5]	3.1 [6.7]	3.2 [7.0]	3.3 [7.3]
Moment of inertia of rotating components	x 10 <sup>-6</sup> kg·m <sup>2</sup> [x 10 <sup>-6</sup> lb·ft <sup>2</sup> ]	26.5 [629]	32.4 [769]	38.4 [911]	47.3 [1122]	53.3 [1265]	59.2 [1405]	68.1 [1616]	74.1 [1758]
Theoretical flow at maximum speed	l/min [US gal/min]	24 [6.3]	33.6 [8.9]	43.2 [11.4]	50.4 [13.3]	50.4 [13.3]	57.6 [15.2]	68.4 [18.0]	75.6 [20.0]

1 kg·m<sup>2</sup> = 23.68 lb·ft<sup>2</sup>

\* Before choosing this frame size, please apply to Turolla technical department.

### ⚠ Caution

The rated and peak pressure mentioned are for motors with flanged ports only. When threaded ports are required a de-rated performance has to be considered. To verify the compliance of a high pressure application with a threaded ports pump apply to a Turolla representative.



## Product Code Model Code

A	B	C	D	E	F	G	H	I	J	K	L	M	N	O
<input type="text"/>	<input type="text"/>	<input type="text"/>	<input type="text"/>	<input type="text"/>	<input type="text"/>	<input type="text"/>	<input type="text"/>	<input type="text"/>	<input type="text"/>	<input type="text"/>	<input type="text"/>	<input type="text"/>	<input type="text"/>	<input type="text"/>

### A Family

<b>SEM2DN</b>	Low Cost Gr2 Bidir.Motor-int.drain
<b>SEM2NL</b>	Low Cost Gr2 Bidirec.Motor-vert.drain
<b>SEM2NN</b>	Low Cost Gr2 Bidirec.Motor
<b>SHM2GL</b>	Hi.Press.Gr2 Bid.Mot.+Antic.Check Val-Vert.drain
<b>SHM2IN</b>	Hi.Press.Gr2 Bidir.Motor+Int.drain RV
<b>SHM2NL</b>	Hi.Press.Gr2 Bidirec.Motor-Vert.drain
<b>SHM2NN</b>	Hi.Press. Gr2 Bidirec.Motor
<b>SHU2GN</b>	Hi.Press. Gr2 Unidir.Motor+Anticav.Check valve
<b>SHU2NN</b>	High Press. Gr2 Unidir.Motor
<b>SKU2NN</b>	Big shaft GR2 Unidir.Motor
<b>SNM2DN</b>	Gr2 Bidir.Motor-Int.Drain
<b>SNM2FL</b>	Gr2 Bidir.Motor+Break.Valve-Vert.drain-Special
<b>SNM2FN</b>	Gr2 Bidir.Motor+Break.Valve-Special
<b>SNM2GC</b>	Gr2 Bidir.Motor+Anticav.Check Val.-Ax.drain
<b>SNM2GL</b>	Gr2 Bidir.Motor-Anticav.Check Val.-vert.drain
<b>SNM2GN</b>	Gr2 Bidir.Motor-Anticav.Check Valve
<b>SNM2IL</b>	Gr2 Bidir.Motor+Int.drain RV-Vert.drain

<b>SNM2IN</b>	Gr2 Bidir.Motor+Int.drain RV
<b>SNM2JN</b>	Gr2 Bid.Motor+Int.drain RV+Anticav.Check Valve
<b>SNM2NC</b>	Gr2 Bidir.Motor-Cover Ports-Ax.drain
<b>SNM2NL</b>	Gr2 Bidir.Motor-Vert.drain
<b>SNM2NN</b>	Gr2 Bidir.Motor
<b>SNM2SN</b>	Gr2 Bidir.Motor+by-pass electric valve-Special
<b>SNU2EN</b>	Gr2 Unidir.Motor+Ext.drain RV
<b>SNU2GN</b>	Gr2 Unidir.Motor+Anticav.Check Valve
<b>SNU2GC</b>	Gr2 Unidir.Motor-In./Out. on Cover+Anticav.Check Valve
<b>SNU2IN</b>	Gr2 Unidir.Motor+Int.drain RV
<b>SNU2JN</b>	Gr2 Unidir.Motor+Int.drain RV+Anticav.Check Valve
<b>SNU2NC</b>	Gr2 Unidir.Motor-In.-Out.on cover
<b>SNU2NN</b>	Gr2 Unidir.Motor
<b>SNU2QN</b>	Gr2 Unid.Motor-Ext.drain RV+Anticav.Check Valve
<b>SNU2TN</b>	Gr2 Unidir.Motor-Break.Valve as Anticav.Valve-Special

### B Displacement

<b>5,5</b>	5,5 cc -Special
<b>6,0</b>	6,0 cc -Special
<b>8,0</b>	8,4 cc
<b>9,0</b>	9,0 cc -Special
<b>9,5</b>	9,5 cc -Special

<b>011</b>	10,8 cc
<b>012</b>	12,0 cc -Special
<b>014</b>	14,4 cc
<b>017</b>	16,8 cc
<b>019</b>	19,2 cc

<b>021</b>	21,0 cc -Special
<b>022</b>	22,8 cc
<b>025</b>	25,2 cc



### C Rotation

B	Bidirectional
L	Unidirectional Left hand
R	Unidirectional Right hand

### D Project version (value representing a change to the initial project)

N	Std Version of Project
2	Std Big-Shaft - Special Unbalanced
4	Precharged seal on cover-Special heavy-duty applications
6	Short version - Special

### E Mounting flange

01	pilot Ø36,5+4 holes
02	pilot Ø80+4 holes
03	pilot Ø52+0-ring+4 holes through body
04	pilot Ø50+2 holes through body
05	pilot Ø50+2 holes through body
06	SAE A pilot Ø82,55+2 holes
B2	pilot Ø80+4 holes+special shaft seal slot - Special
L5	pilot Ø52 spigot Diameter+0-Ring+4 holes through body - Special
Q2	pilot Ø80+4 holes+fastening holes Ø10,5mm- Special
91	Outrigger Bearing Type 01+taper shaft 1:8-M12x1,25-Key4
92	Outrigger Bearing Type 02+taper shaft 1:5-M12x1,25-Key3
94	Outrigger Bearing Type 04+taper shaft 1:5-M12x1,25-Key3
9A	Outrigger Bearing Type 01+taper shaft 1:8-M12x1,25-Key3.2
9D	Outrigger Bearing Type 01+parallel shaft Ø15-Key4
9F	Outrigger Bearing Type 02+taper shaft 1:5-M14x1,5-Key4+special shaft seal RZB
9G	Outrigger Bearing Type 04+taper shaft 1:5-M12x1,25-Key3 + 4 M10 assembly thd holes "HELI-COIL- Special
9H	Outrigger Bearing Type 06+taper shaft 1:8-M12x1,25-Key4
9J	Outrigger Bearing Type 06 with parallel shaft Ø3/4 (Ø19.05 mm)
9L	Outrigger Bearing Type 01 parallel shaft Ø22 pilot Ø50,8
9M	Outrigger Bearing Type 01 parallel shaft Ø18 pilot Ø36,5



## F Drive gear

AA	Taper 1:5-M12x1,25-Key 3
AC	Taper 1:5-M14x1,5-Key 4
AD	Taper 1:5-M12X1,25-Key 3-Drive - Special for Version 6
B1	Taper 1:8-M12x1,25-Key 4/6 lowered
BA	Taper 1:8-M12x1,25-Key 4
BB	Taper 1:8-M12x1,25-Key 4/3,2
BJ	Taper 1:8-M12x1,25-Key 4/3 black steel
CA	Tang 8x17,8xL6,5 FR03
CF	Tang 8x Ø17,46xL9,6-Special
DA	Spline DIN 5482 B17x14-L10
DB	Spline DIN 5482 B17x14-L14
DL	Spline DIN 5482 B17x14-L14+rear spline DIN 5482 17x14-L14 SC32..._2 - Special
EC	Spline DIN 5480 W20x1,25xz14-9g - Special
FA	Parallel Ø15-L30+Key 4x25
GA	Parallel SAE Ø15,875-L23,8-Key 4x18
GB	Parallel SAE Ø15,875-L50,8-Key 4x40
GC	Parallel SAE Ø17,46-L24,4-Key 3/16x3/16xL20 - Special
SA	Spline SAE J498-9T-16/32
SB	Spline SAE J498-11T-16/32 -Special only for Version 2
SE	Spline SAE J498-9T-16/32+M6 thd hole
SF	Spline SAE J498-9T-16/32-reinforced fillet
SG	Spline SAE J498-11T-16/32-Special only for Version 2
SI	Spline SAE J498-11T-16/32-Special only for Version 2
TC	Spline SAE 13T-20/40-Special



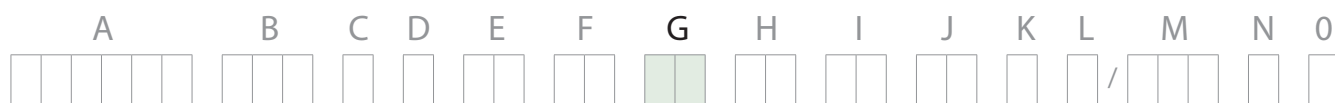

## G Rear cover

<b>C7</b>	Cover for unidirec. motors front SAE ports: Inlet 3/4-16UNF-2B;Outlet 3/4-16UNF-2B
<b>E1</b>	Cover for unidirectional motors with relief valve - external drain 3/8 Gas
<b>E6</b>	Cover for unidirectional motors with Relief Valve ext.drain 3/4-16UNF-2B
<b>F1</b>	Cover motor per braking valve and drain 1/4 Gas
<b>F6</b>	Cover motor per braking valve and drain 9/16-18UNF-2B
<b>G1</b>	Cover motor front ports:Inlet 1/2 G;Outlet 1/2 G;Drain 1/4 G
<b>G6</b>	Cover motor front ports:Inlet 7/8-14UNF;Outlet 7/8-14UNF;Drain 9/16-18UNF
<b>I1</b>	Cover for unidirectional motors with RV
<b>J1</b>	Cover motor per braking valve with drain in vertical axis 1/4 G
<b>J6</b>	Cover motor per braking valve with side drain in vertical axis 9/16-18UNF-2B
<b>L1</b>	Cover motor-drain in vertical axis 1/4 Gas
<b>L3</b>	Cover motor-drain in vertical axis 1/4 Gas for flange typo 03
<b>L6</b>	Cover motor-drain in vertical axis 9/16-18UNF-2B
<b>L7</b>	Cover motor-drain at 22° left 7/16-20UNF-2B
<b>L8</b>	Cover motor-drain in horizontal axis 9/16-18UNF-2B drain left
<b>LC</b>	Cover motor-drain in horizontal axis 1/4 Gas right side
<b>LD</b>	Cover motor-drain in horizontal axis 1/4 Gas left side
<b>LE</b>	Cover motor-drain in horizontal axis M12x1,25 ISO 6149
<b>LF</b>	Cover motor-drain in horizontal axis M12x1,5 right side
<b>LH</b>	Cover motor-drain in horizontal axis 9/16-18UNF-2B drain right

<b>LS</b>	Cover motor-drain at 22° left 7/16-20UNF-2B drive gear side
<b>LT</b>	Cover motor-drain in vertical axis 1/4 Gas for flange typo 03 drive gear side
<b>LX</b>	Cover motor-drain in vertical axis 9/16-18UNF-2B drive gear side
<b>LZ</b>	Cover motor-drain in vertical axis 1/4 Gas drive gear side
<b>M1</b>	Std cover motor drain 1/4 Gas driven side
<b>M3</b>	Std cover motor drain 1/4 Gas for flange typo 03
<b>M4</b>	Std cover motor drain 9/16-18UNF-2B for flange typo 03
<b>M6</b>	Std cover motor drain 9/16-18UNF-2B
<b>M7</b>	Std cover motor-drain 1/4 Gas drive side
<b>M8</b>	Special intermediate motor flange tipo 01-drain 1/4 Gas - Special
<b>P1</b>	Std cover for unidirectional motors
<b>P3</b>	Std cover for unidirectional motors for flange typo 03
<b>S1</b>	Cover motor-Electric-piloted distributor+by-pass-drain vert.1/4 G-In-Out 1/2 G - Special
<b>T1</b>	Cover motor per braking valve used as anti-cavitation valve internal drain - Special
<b>v1</b>	Cover motor per RV with drain 1/4 Gas
<b>v2</b>	Cover motor per RV with drain vertical axis 1/4 Gas driven side
<b>v6</b>	Cover motor per RV with drain 9/16-18UNF-2B
<b>v7</b>	Cover motor per RV with drain vertical axis 9/16-18UNF-2B driven side



## H Inlet size    I Outlet size

<b>NN</b>	Without inlet	
<b>B3</b>	13,5x30xM6 in X	
<b>B5</b>	15x35xM6	
<b>B6</b>	15x40xM6	
<b>B7</b>	20x40xM6	
<b>BB</b>	27x55xM8	
<b>C2</b>	12x26xM5	
<b>C3</b>	13,5x30xM6	
<b>C4</b>	15x35xM6 DXK(+)	
<b>C5</b>	13,5x40xM8	
<b>C6</b>	20x40xM6 DXK(+)	
<b>C7</b>	20x40xM8	
<b>C8</b>	23,5x40xM8	
<b>CS</b>	13,5x30xM6 (2 holes)	
<b>CV</b>	20x40xM8 (2 holes at 30°)	
<b>CX</b>	20x40xM8 (2 holes)	
<b>CY</b>	20x40xM8 (3 holes)	
<b>D4</b>	M16x1,5	
<b>D5</b>	M18x1,5	
<b>D7</b>	M22x1,5	
<b>D9</b>	M26x1,5	
<b>E3</b>	9/16-18UNF	
<b>E4</b>	3/4-16UNF	
<b>E5</b>	7/8-14UNF	
<b>E6</b>	1-1/16-12UN	
<b>E8</b>	1-5/16-12UN	

<b>F3</b>	3/8 GAS	
<b>F4</b>	1/2 GAS	
<b>F5</b>	3/4 GAS	
<b>F6</b>	1 GAS	
<b>H5</b>	M18x1,5-ISO6149	
<b>H7</b>	M22x1,5-ISO6149	
<b>H8</b>	M27x2-ISO6149	
<b>H9</b>	M33x2-ISO6149	
<b>M1</b>	12x17,48x38,1xM6	
<b>M2</b>	12x17,48x38,1xM8	
<b>M3</b>	18,5x17,48x38,1xM8	
<b>M5</b>	25/20x52,37x26,19xM10	
<b>MB</b>	12x38,1x17,48xM8(=)	
<b>MC</b>	18,5x47,63x22,23xM6(=)	
<b>MD</b>	18,5x47,63x22,23xM8(=)	
<b>ME</b>	18,5x47,63x22,23xM10(=)	
<b>MG</b>	25/20x52,37x26,19xM10(=)	
<b>MH</b>	31/25x58,72x30,18xM10(=)	

## J Ports Pos & Spec Body

<b>NN</b>	Std from catalogue
<b>YY</b>	Port Bx-Bx with flange SAE-A; off-set to rear cover
<b>EU</b>	Dist. from front flange=58,5 - Special
<b>F9</b>	Dist. from front flange=69 - Special
<b>PL</b>	Inlet port Left position looking gear drive from front flange

<b>PR</b>	Inlet port Right position looking gear drive from front flange
<b>TD</b>	Nr.4 milling D.27 tigh.16 flange side - Special
<b>TE</b>	Nr.4 milling D.27 tigh.20 flange side - Special
<b>ZZ</b>	Port Bx-Bx in the center of the body - Option



## K Seals

N	Standard NBR seals
B	VITON seals (only for unidirectional motors)
D	VITON shaft seal with dust lip (type BABSL)
F	VITON seals except for shaft seal - Special
X	NBR seals+Dust Cover
Y	VITON seals + Dust Cover
Z	VITON shaft seal + Dust Cover

## L Screws

N	Std burnished screws
A	Zinc plated screws
C	Galvanized nuts - Special

## M Set valves

NNN	No valve
V**	not defined-pressure no setting :oil ISO VG68-45°

## N Type of mark

N	Standard Turolla Marking
A	Standard Turolla Marking+Customer Code-Special
Z	Without Marking

## O Mark position

N	Std Marking position (on top)
A	Special Marking position on the bottom



### Motor performance graphs

The graphs on the next few pages provide typical output flow and input power for Group 2 motors at various working pressures. Data were taken using ISO VG46 petroleum /mineral based fluid at 50 °C [122 °F] (viscosity = 28 mm<sup>2</sup>/s [132 SUS]).

SNM2NN/6,0 motor performance graph

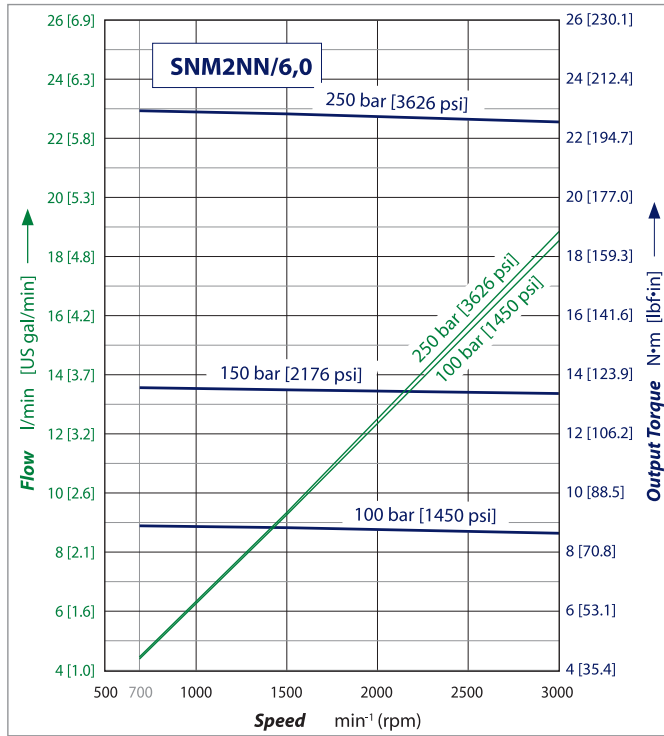

SNM2NN/8,0 motor performance graph

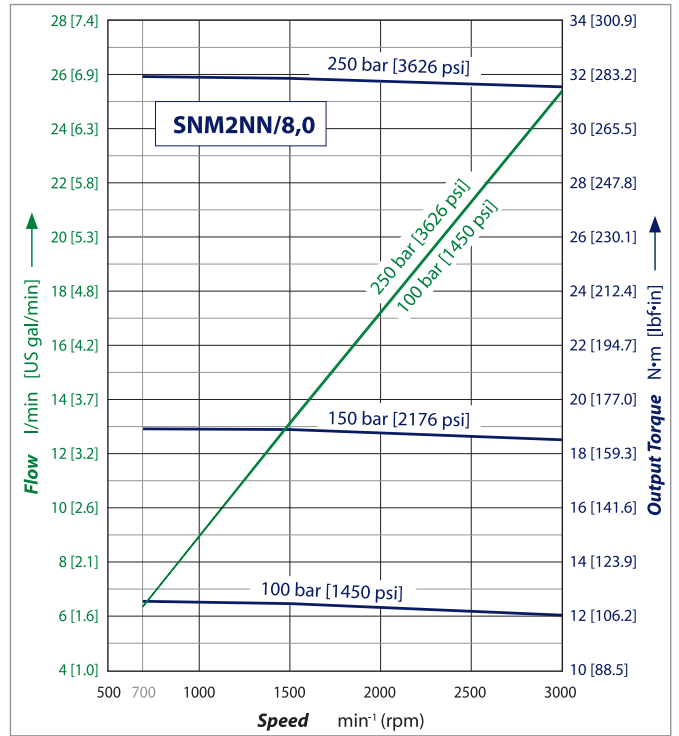

SNM2NN/011 motor performance graph

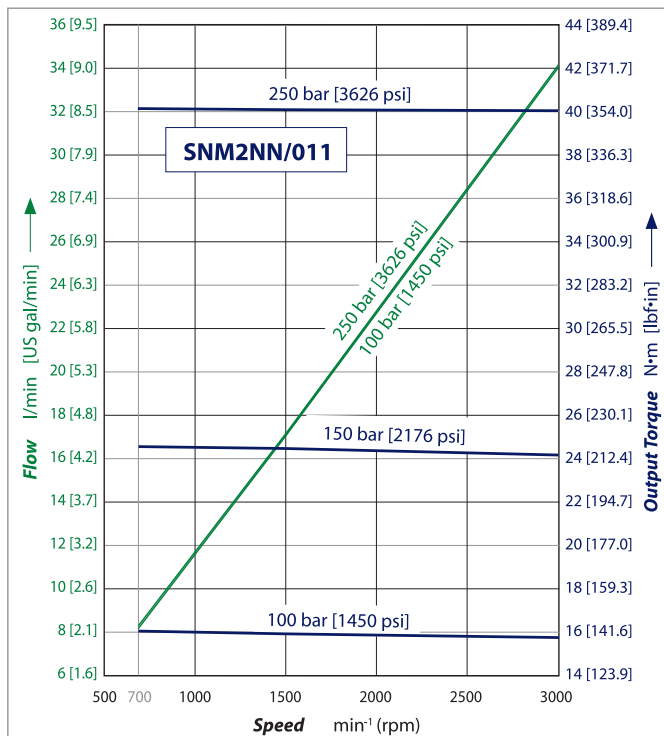

SNM2NN/014 motor performance graph

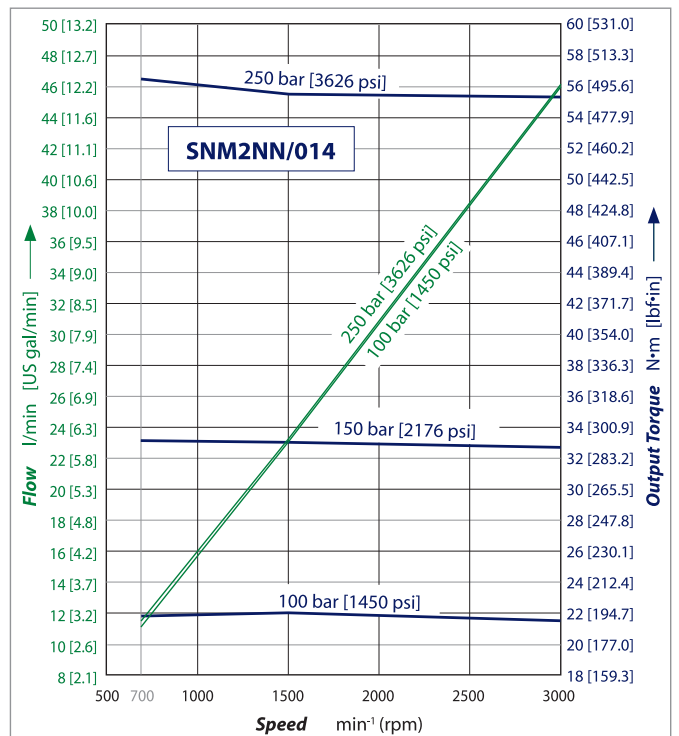



SNM2NN/017 motor performance graph

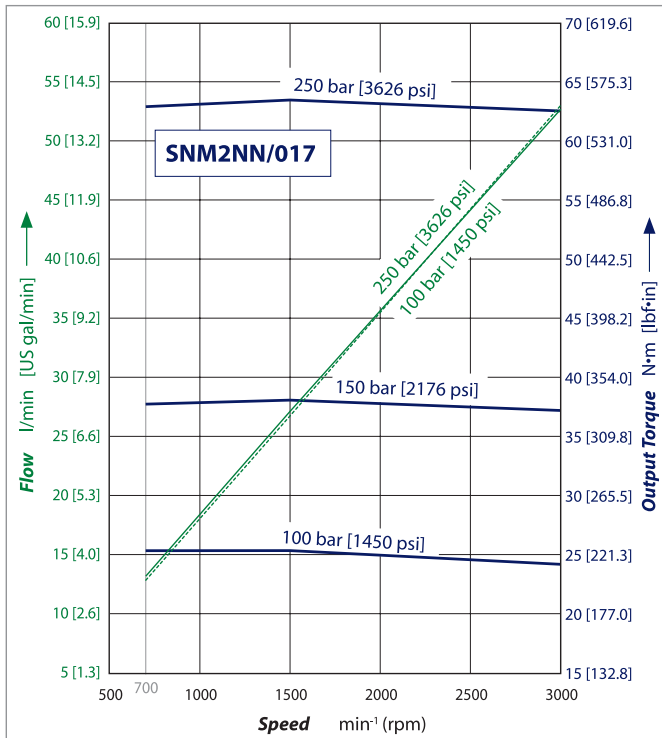

SNM2NN/019 motor performance graph

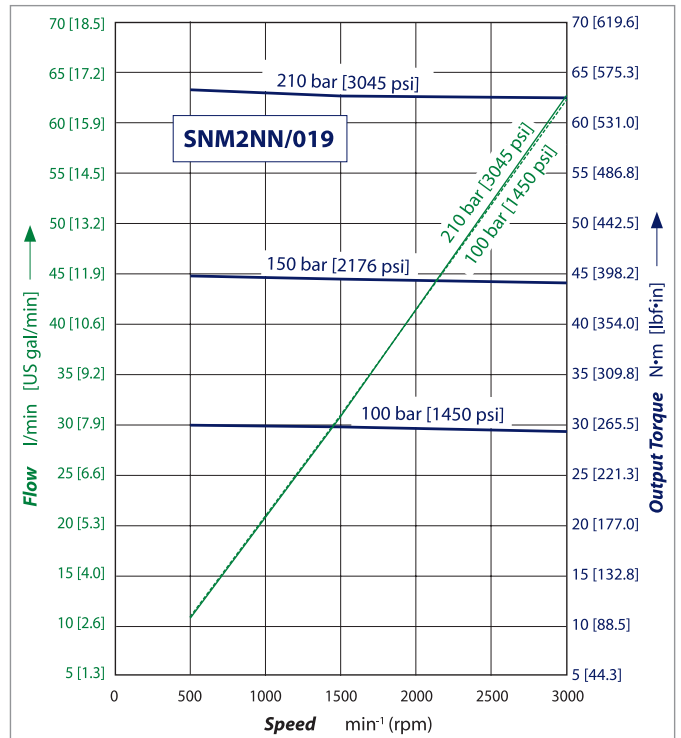

SNM2NN/022 motor performance graph

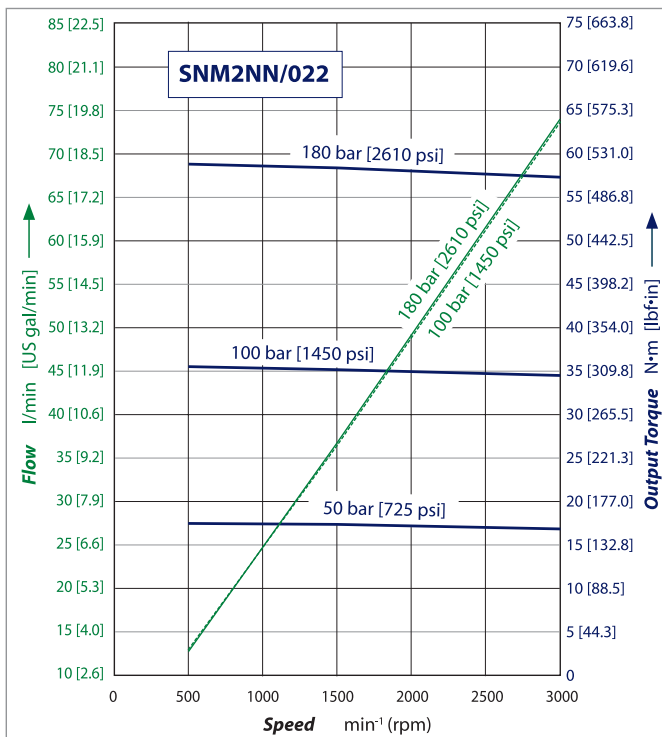



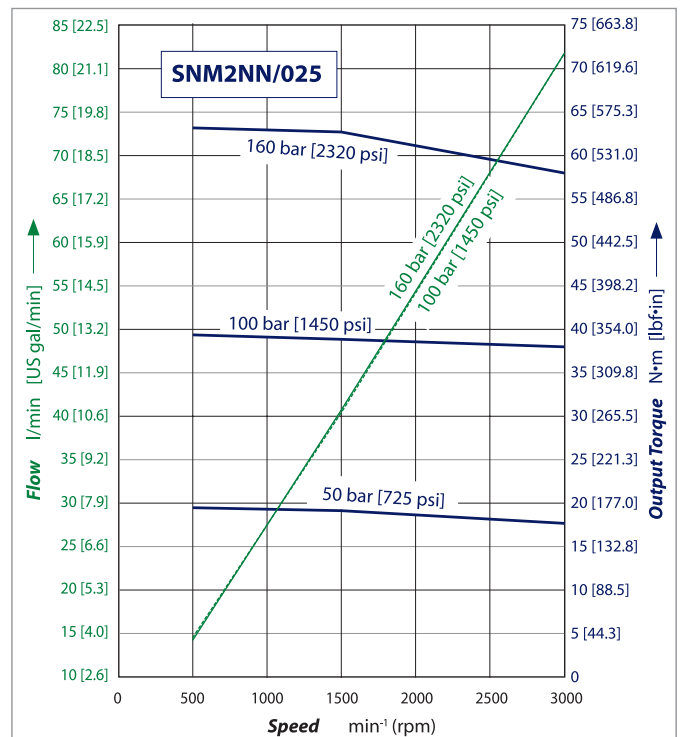







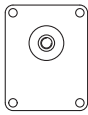
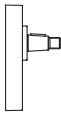
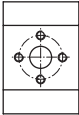
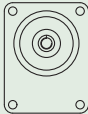

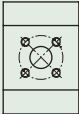
SNM2NN/025 motor performance graph

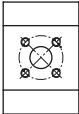
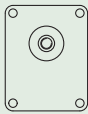
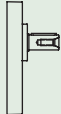

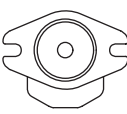
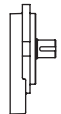
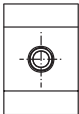
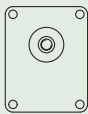

## Flange, shaft and port configurations

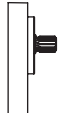
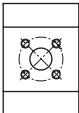
Flange, shaft and port configurations for SNM2NN and SNU2NN motors

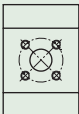
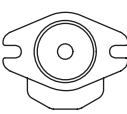
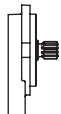
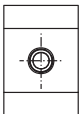
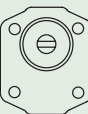
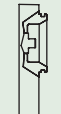
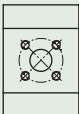
Code	Flange	Shaft	Port
<b>01BA</b>	European 01, 4-bolts pilot Ø 36.5 mm [1.44 in] 	1:8 tapered 	European in <b>+</b> pattern 
<b>02AA</b>	European 02, 4-bolts pilot Ø 80 mm [3.15 in] 	1:5 tapered 	German standard in <b>X</b> pattern 
<b>04AA/ 05AA</b>	German PTO 2-bolts pilot Ø 50 mm [1.97 in] 	1:5 tapered 	German standard in <b>X</b> pattern 
<b>01FA</b>	European 01, 4-bolts pilot Ø 36.5 mm [1.44 in] 	Ø 15 mm [0.59 in] parallel 	European in <b>+</b> pattern 
<b>06GA</b>	SAE A pilot Ø 82.55 mm [3.25 in] 	Ø 15.7 mm [0.625 in] parallel 	Threaded SAE O-ring boss port 
<b>01DA</b>	European 01, 4-bolts pilot Ø 36.5 mm [1.44 in] 	9-teeth splined $m = 1.60, \alpha = 30^\circ$ DIN 5482-B17x14 	European in <b>+</b> pattern 
<b>02DB</b>	European 02, 4-bolts pilot Ø 80 mm [3.15 in] 	9-teeth splined $m = 1.60, \alpha = 30^\circ$ DIN 5482-B17x14 	German standard in <b>X</b> pattern 
<b>04DB/ 05DB</b>	German PTO 2-bolts pilot Ø 50 mm [1.97 in] 	9-teeth splined $m = 1.60, \alpha = 30^\circ$ DIN 5482-B17x14 	German standard in <b>X</b> pattern 
<b>06SA</b>	SAE A pilot Ø 82.55 mm [3.25 in] 	SAE 9-teeth splined 	Threaded SAE O-ring boss port 
<b>03CA</b>	Turolla tang pilot Ø 52 mm [2.066 in] 	Turolla standard tang 	German standard in <b>X</b> pattern 



### Shaft options

Group 2 motors are available with a variety of splined, parallel, and tapered shaft ends. Not all shaft styles are available with all flange styles.

Valid combinations and nominal torque ratings are shown in the table below. Torque ratings assume no external radial loading. Applied torque must not exceed these limits regardless of pressure parameters stated earlier. Maximum torque ratings are based on shaft torsional fatigue strength.

Shaft availability and nominal torque capability

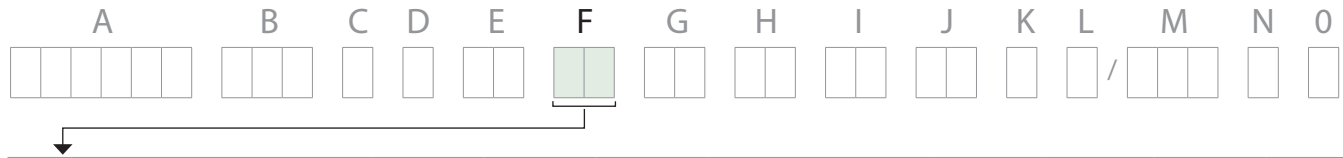

Shaft		Mounting flange code with maximum torque in N·m [lb·in]								
Code	Description	01	02	B2	Q2	03	04	05	L5	06
AA	Taper 1:5-M12x1,25-Key 3		140 [1239]	140 [1239]			140 [1239]	140 [1239]		
AC	Taper 1:5-M14x1,5-Key 4				140 [1239]					
AD	Taper 1:5-M12X1,25-Key 3-Drive (Version 6 only)		140 [1239]					140 [1239]	140 [1239]	
B1	Taper 1:8-M12x1,25-Key 4/6 lowered	150 [1328]								
BA	Taper 1:8-M12x1,25-Key 4	150 [1328]					150 [1328]	150 [1328]		150 [1328]
BB	Taper 1:8-M12x1,25-Key 4/3,2	150 [1328]								150 [1328]
BJ	Taper 1:8-M12x1,25-Key 4/3 black steel							150 [1328]		
CA	Tang 8x17,8xL6,5 FR03					70 [620]				
CF	Tang 8x Ø17,46xL9,6-Special									
DA	Spline DIN 5482 B17x14-L10	90 [797]								
DB	Spline DIN 5482 B17x14-L14		130 [1151]	130 [1151]			130 [1151]	130 [1151]		
FA	Parallel Ø15-L30+Key 4x25	90 [797]								
GA	Parallel SAE Ø15,875-L23,8-Key 4x18									80 [708]
GB	Parallel SAE Ø15,875-L50,8-Key 4x40									80 [708]
SA	Spline SAE J498-9T-16/32									75 [646]
SB	Spline SAE J498-11T-16/32 (Version 2 only)									150 [1328]
SE	Spline SAE J498-9T-16/32+M6 thd hole									75 [646]
SF	Spline SAE J498-9T-16/32-reinforced fillet									90 [797]
SG	Spline SAE J498-11T-16/32 (Version 2 only)									150 [1328]
SI	Spline SAE J498-11T-16/32 (Version 2 only)									150 [1328]

Recommended mating splines for Group 2 splined output shafts should be in accordance with SAE J498 or DIN 5482. Turolla external SAE splines are flat root side fit with circular tooth thickness reduced by 0.127 mm [0.005 in] in respect to class 1 fit. The external DIN splines have an offset increased by 0.1 mm [0.004 in.] These dimensions are modified in order to assure a clearance fit with the mating spline.

Other shaft options may exist. Contact your Turolla representative for availability.

### ⚠ Caution

Shaft torque capability may limit allowable pressure. Torque ratings assume no external radial loading. Applied torque must not exceed these limits, regardless of stated pressure parameters. Maximum torque ratings are based on shaft torsional fatigue strength.



## Port dimensions

Available ports for Group 2 motors

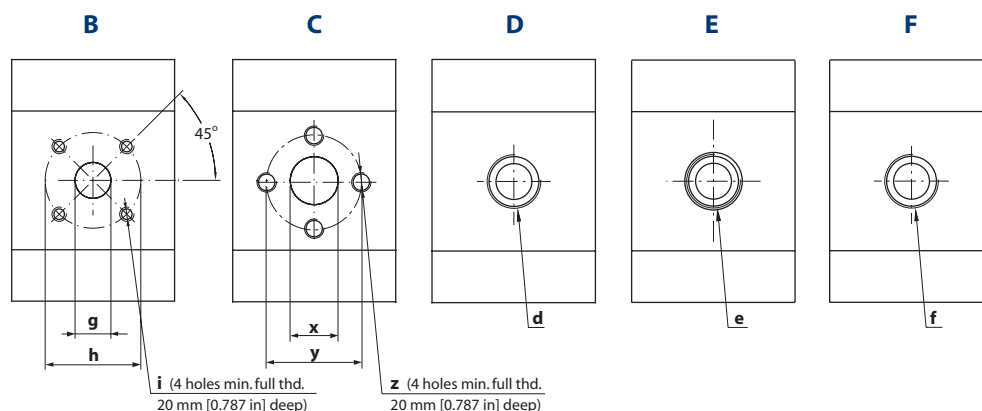

## Bidirectional motor ports dimensions

SNM2NN bidirectional motors and SNM2GN, SNM2JN, SNM2IN motors made unidirectional only by the valve

Port type		B			C			D	E	F
Port dimensions		g	h	i	x	y	z	d	e	f
Frame size	6,0 Inlet/Outlet	15 [0.59]	35 [1.38]	M6	13.5 [0.53]	30 [1.18]	M6	M22x1.5	7/8-14UNF-2B	1/2 Gas (BSPP)
	8,0 Inlet/Outlet	15 [0.59]	35 [1.38]	M6	13.5 [0.53]	30 [1.18]	M6	M22x1.5	7/8-14UNF-2B	1/2 Gas (BSPP)
	011 Inlet/Outlet	15 [0.59]	35 [1.38]	M6	13.5 [0.53]	30 [1.18]	M6	M22x1.5	7/8-14UNF-2B	1/2 Gas (BSPP)
	014 Inlet/Outlet	15 [0.59]	35 [1.38]	M6	20 [0.79]	40 [1.58]	M8	M22x1.5	7/8-14UNF-2B	1/2 Gas (BSPP)
	017 Inlet/Outlet	15 [0.59]	35 [1.38]	M6	20 [0.79]	40 [1.58]	M8	M22x1.5	7/8-14UNF-2B	1/2 Gas (BSPP)
	019 Inlet/Outlet	20 [0.79]	40 [1.58]	M6	20 [0.79]	40 [1.58]	M8	M26x1.5	1-1/16-12UNF-2B	3/4 Gas (BSPP)
	022 Inlet/Outlet	20 [0.79]	40 [1.58]	M6	20 [0.79]	40 [1.58]	M8	M26x1.5	1-1/16-12UNF-2B	3/4 Gas (BSPP)
	025 Inlet/Outlet	20 [0.79]	40 [1.58]	M6	23.5 [0.92]	40 [1.58]	M8	M26x1.5	1-1/16-12UNF-2B	3/4 Gas (BSPP)
Drain		1/4 Gas (BSPP)						9/16-18UNF-2B		1/4 Gas (BSPP)

## Unidirectional motor ports dimensions

SNU2NN and SKU2NN ports dimensions

Port type		B			C			D	E	F	
Port dimensions		g	h	i	x	y	z	d	e	f	
Frame size	8,0	Inlet	15 [0.59]	35 [1.38]	M6	13.5 [0.53]	30 [1.18]	M6	M18x1.5	1-1/16-12UNF-2B	1/2 Gas (BSPP)
		Outlet	20 [0.79]	40 [1.58]	M6	13.5 [0.53]	30 [1.18]	M6	M16x1.5	7/8-14UNF-2B	1/2 Gas (BSPP)
	011	Inlet	15 [0.59]	35 [1.38]	M6	13.5 [0.53]	30 [1.18]	M6	M18x1.5	1-1/16-12UNF-2B	3/4 Gas (BSPP)
		Outlet	20 [0.79]	40 [1.58]	M6	13.5 [0.53]	30 [1.18]	M6	M16x1.5	7/8-14UNF-2B	1/2 Gas (BSPP)
	014	Inlet	15 [0.59]	35 [1.38]	M6	13.5 [0.53]	30 [1.18]	M6	M18x1.5	1-1/16-12UNF-2B	3/4 Gas (BSPP)
		Outlet	20 [0.79]	40 [1.58]	M6	20 [0.79]	40 [1.58]	M8	M16x1.5	7/8-14UNF-2B	1/2 Gas (BSPP)
	017	Inlet	15 [0.59]	35 [1.38]	M6	13.5 [0.53]	30 [1.18]	M6	M18x1.5	1-1/16-12UNF-2B	3/4 Gas (BSPP)
		Outlet	20 [0.79]	40 [1.58]	M6	20 [0.79]	40 [1.58]	M8	M18x1.5	7/8-14UNF-2B	1/2 Gas (BSPP)
	019	Inlet	15 [0.59]	35 [1.38]	M6	13.5 [0.53]	30 [1.18]	M6	M18x1.5	1-1/16-12UNF-2B	3/4 Gas (BSPP)
		Outlet	20 [0.79]	40 [1.58]	M6	20 [0.79]	40 [1.58]	M8	M18x1.5	7/8-14UNF-2B	1/2 Gas (BSPP)
	022	Inlet	15 [0.59]	35 [1.38]	M6	13.5 [0.53]	30 [1.18]	M6	M18x1.5	1-1/16-12UNF-2B	3/4 Gas (BSPP)
		Outlet	20 [0.79]	40 [1.58]	M6	20 [0.79]	40 [1.58]	M8	M18x1.5	7/8-14UNF-2B	1/2 Gas (BSPP)
	025	Inlet	15 [0.59]	35 [1.38]	M6	13.5 [0.53]	30 [1.18]	M6	M18x1.5	1-1/16-12UNF-2B	1 Gas (BSPP)
		Outlet	20 [0.79]	40 [1.58]	M6	20 [0.79]	40 [1.58]	M8	M18x1.5	7/8-14UNF-2B	3/4 Gas (BSPP)





### Integral relief valve – SNM2IN

Turolla offers an optional **integral relief valve** integrated in the Group 2 motors rear cover. It is drained internally and directs all the flow from the motor inlet to the outlet when the inlet pressure reaches the valve setting.

The tables below show applicable variant codes for ordering motors with integral relief valve. Refer to **Model Code**, page 35 for more information.

Valve schematic diagram

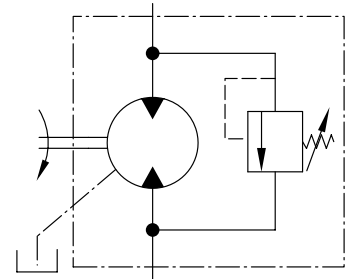

Integral relief valve rear cover cross section

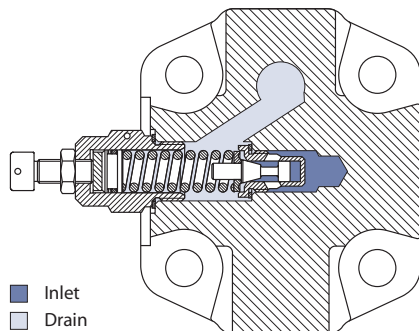

Pressure vs flow

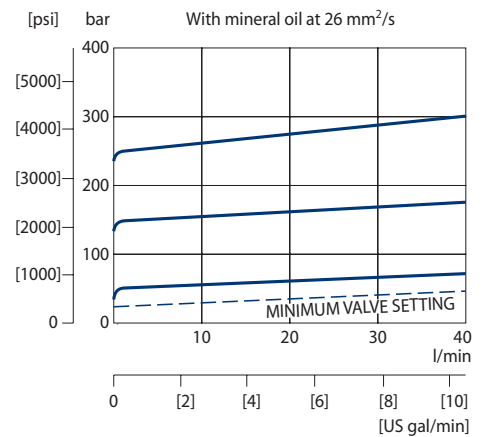

### Variant codes for ordering integral relief valve



M Variant code (left part)

Code	Motor speed for RV setting min <sup>-1</sup> (rpm)
A	not defined
C	500
E	1000
F	1250
G	1500
K	2000
I	2250
L	2500
M	2800
N	3000
O	3250

M Variant code (right part)

Code	Pressure setting bar [psi]
A	no setting
B	no valve
C	18 [261]
D	25 [363]
E	30 [435]
F	35 [508]
G	40 [580]
J	150 [2175]
K	50 [725]
L	60 [870]
M	70 [1015]
N	80 [1160]

Code	Pressure setting bar [psi]
O	90 [1305]
P	100 [1450]
Q	110 [1595]
R	120 [1740]
S	130 [1885]
T	140 [2030]
U	160 [2321]
V	170 [2466]
W	180 [2611]
X	210 [3046]
Z	250 [3626]



### Anti-cavitation check valve – SNM2GN

Turolla offers an optional **integral anti-cavitation check valve** integrated in Group 2 motors bearing blocks. Available for all the displacements, the valve directs internally the flow from the motor outlet to the inlet, when the outlet pressure gets higher than the inlet one.

Valve schematic diagram

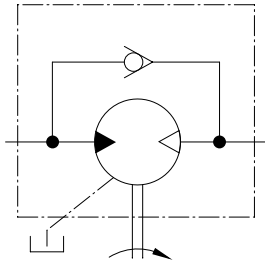

Anticavitation check valve cross section

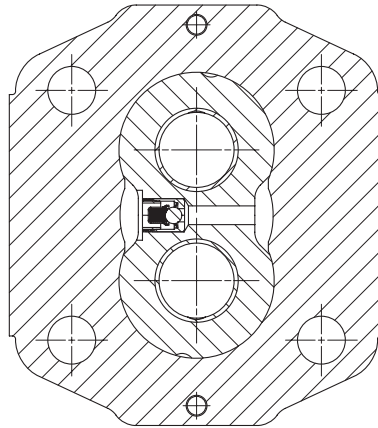

### Integral relief valve and Anti-cavitation check valve – SNM2JN

Turolla offers the Group 2 motors with an optional **integral relief valve** integrated in the rear cover and **anti-cavitation check valve** integrated in the bearing block. The integral relief valve is drained internally and directs all the flow from the motor inlet to the outlet when the inlet pressure reaches the valve setting. The anti-cavitation check valve directs internally the flow from the motor outlet to the inlet, when the outlet pressure gets higher than the inlet one.

Valve schematic diagram

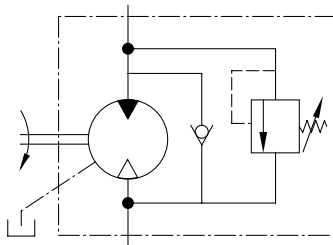



### Outrigger bearing assembly – SNM2NN

An **outrigger bearing** is available for applications with high radial or thrust loads on the shaft. This option is used primarily for applications with high shaft loads. The design utilizes roller bearings in the front mounting flange. These bearings absorb the radial and thrust loads on the shaft so that the life of the motor is not affected. The use of roller bearings allows life to be described in  $B_{10}$  hours.

Available configurations



Flange/Shaft Code*	Mounting Flange	Shaft
9A	European 4-bolt	Taper 1:8
9F	German PTO	Taper 1:5
94	German 4-bolt	Taper 1:5
9H	SAE A	Taper 1:8
9J	SAE A	Parallel

\* Codes represent assembly (complete motor with outrigger bearing).

The table above shows applicable variant codes for ordering motors with outrigger bearing. Refer to **Model Code**, page 31 for more information.



### Outrigger bearing assembly – SNM2NN

The graphs below show allowable shaft loads for 1000 hour life at 1500 min<sup>-1</sup> (rpm) versus distance from flange face to center of radial load.

Radial load vs distance from flange

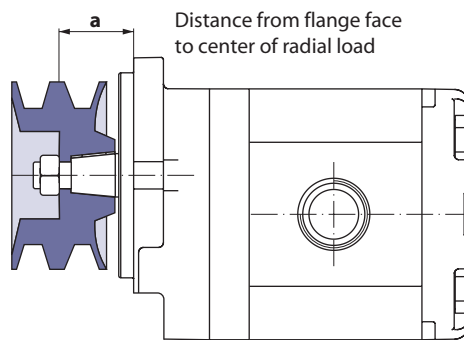
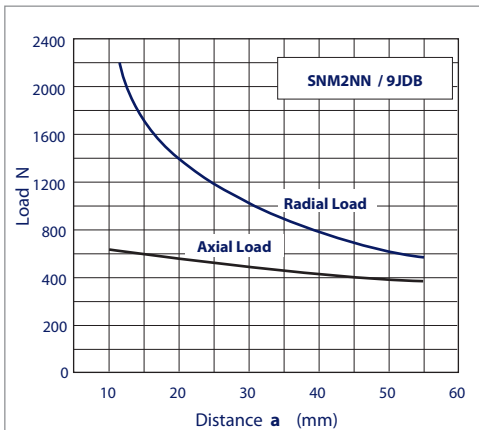
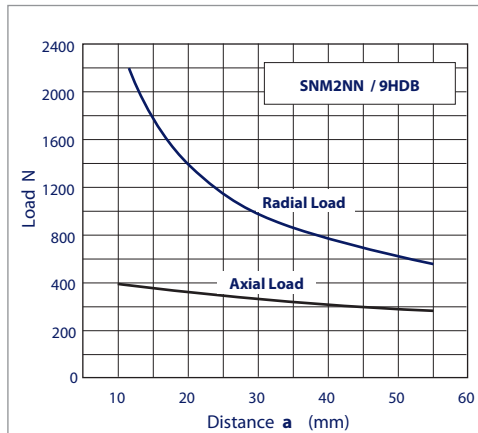
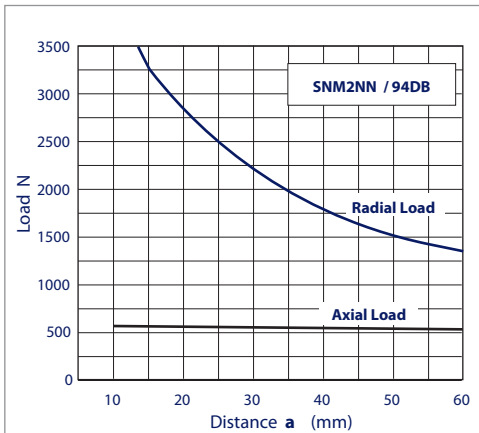
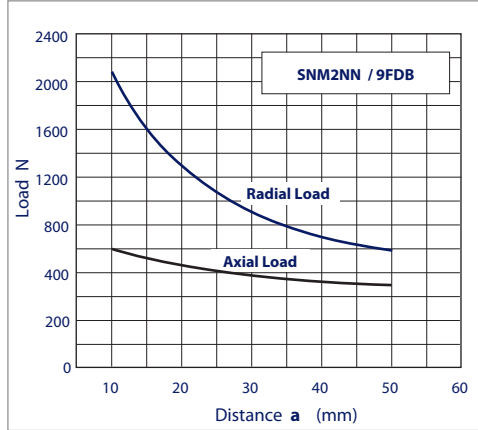
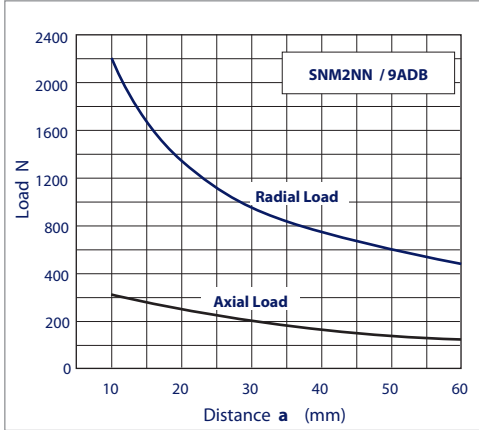



Outrigger bearing 9A

mm  
[in]

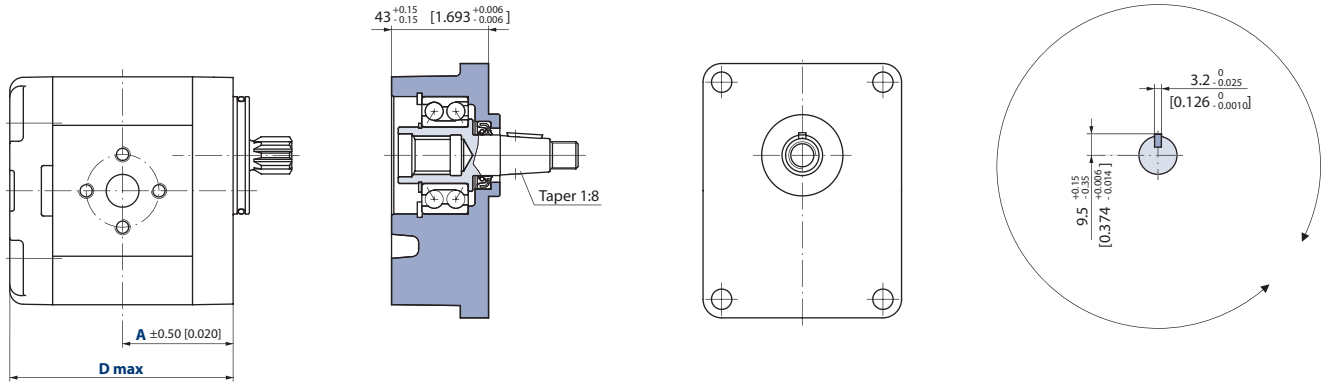

Outrigger bearing 94

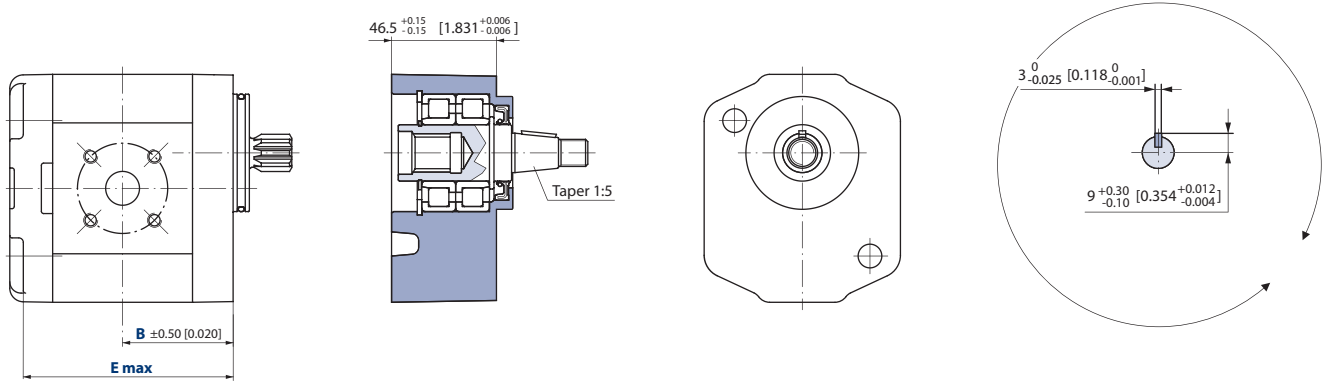

Outrigger bearing 9J

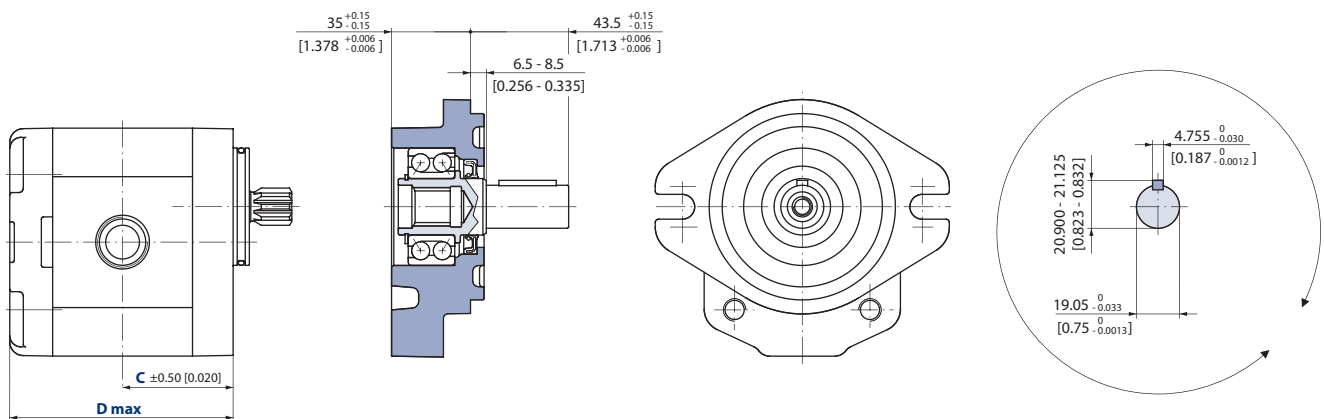



## Outrigger bearing 9F

mm  
[in]

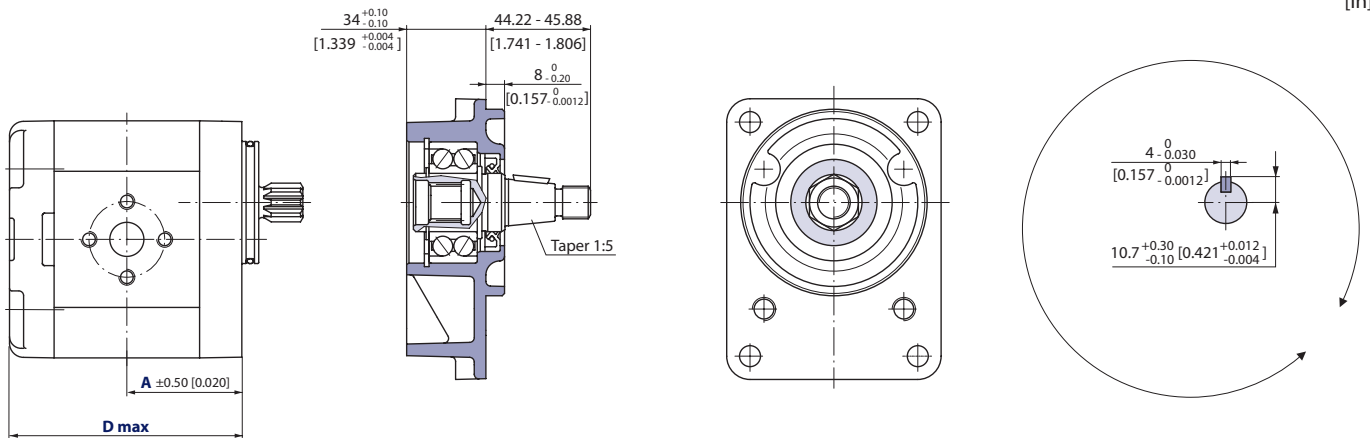

## Outrigger bearing 9H

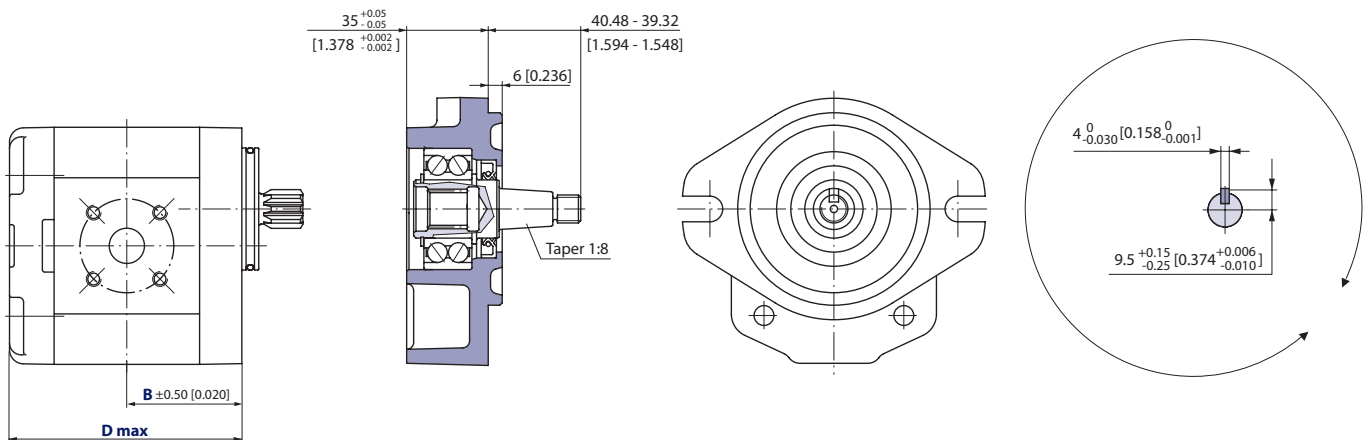

## Dimensions

Frame size	6,0*	8,0	011	014	017	019	022	025	
Dimension	A	45 [1.772]	45 [1.772]	49 [1.929]	52 [2.047]	52 [2.047]	56 [2.205]	59 [2.323]	59 [2.323]
	B	38.6 [1.520]	40.6 [1.598]	45 [1.772]	45 [1.772]	45 [1.772]	45 [1.772]	52.5 [2.067]	62 [2.441]
	C	45 [1.772]	47 [1.850]	49 [1.929]	52 [2.047]	54 [2.126]	56 [2.205]	59 [2.323]	61 [2.402]
	D	93.5 [3.681]	97.5 [3.839]	101.5 [3.996]	107.5 [4.232]	111.5 [4.390]	115.5 [4.574]	121.5 [4.783]	125.5 [4.941]
	E	85 [3.346]	89 [3.504]	93 [3.661]	99 [3.897]	103 [4.055]	107 [4.212]	113 [4.448]	117 [4.606]



# Dimensions

## SNM2NN, SNU2NN – 01DA, 01FA and 01BA

Standard porting drawing for 01DA, 01FA and 01BA

mm  
[in]

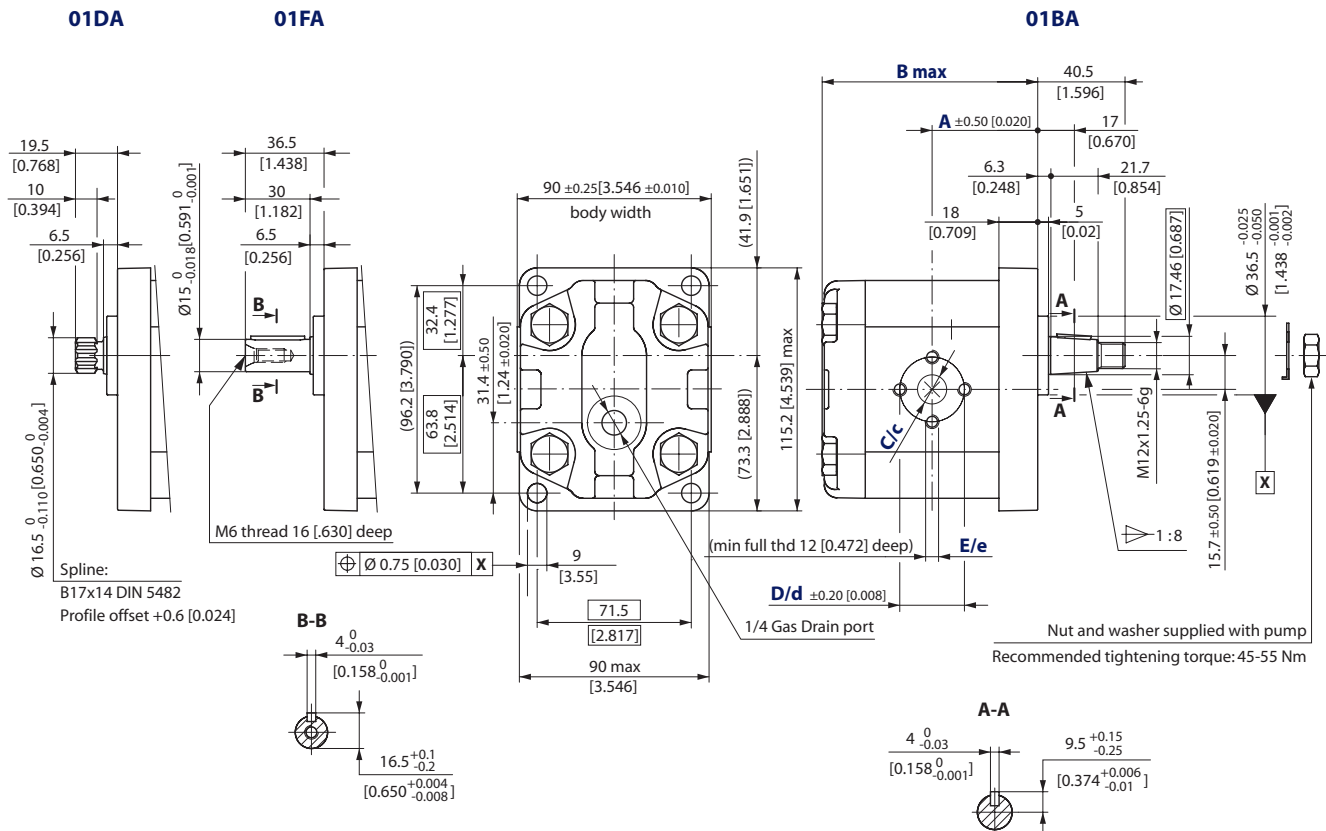

For unidirectional motors no case drain hole into the rear cover.

### Bidirectional motors dimensions – 01DA, 01FA and 01BA

Frame size	6,0*	8,0	011	014	017	019	022	025
Dimension	<b>A</b>	45 [1.771]	49 [1.929]	52 [2.047]	56 [2.204]	59 [2.322]		
	<b>B</b>	93.5 [3.681]	97.5 [3.838]	101.5 [3.996]	107.5 [4.232]	111.5 [4.389]	121.5 [4.783]	125.5 [4.940]
Inlet/Outlet	<b>C/c</b>	13.5 [0.531]		20 [0.787]		23.5 [0.925]		
	<b>D/d</b>	30 [1.181]			40 [1.58]			
	<b>E/e</b>	M6			M8			

\* Before choosing this frame size, please apply to Turolla technical department.

For unidirectional SNU2NN dimensions, see [SNU2NN ports](#), page 40.

### Model code examples and maximum shaft torque

Flange/drive gear	Model code example	Maximum shaft torque
<b>01DA</b>	SNM2NN/8,0BN01DAM1C3C3NNNN/NNNNN	90 N·m [797 lb·in]
<b>01FA</b>	SNM2NN/022BN01FAM1C7C7NNNN/NNNNN	90 N·m [797 lb·in]
<b>01BA</b>	SNM2NN/017BN01BAM1C7C7NNNN/NNNNN	150 N·m [1328 lb·in]

For further details on ordering, see [Model Code](#), pages 30-35.



**SNM2NN, SNU2NN – 02DB and 02AA**  
Standard porting drawing for 02DB and 02AA

mm  
[in]

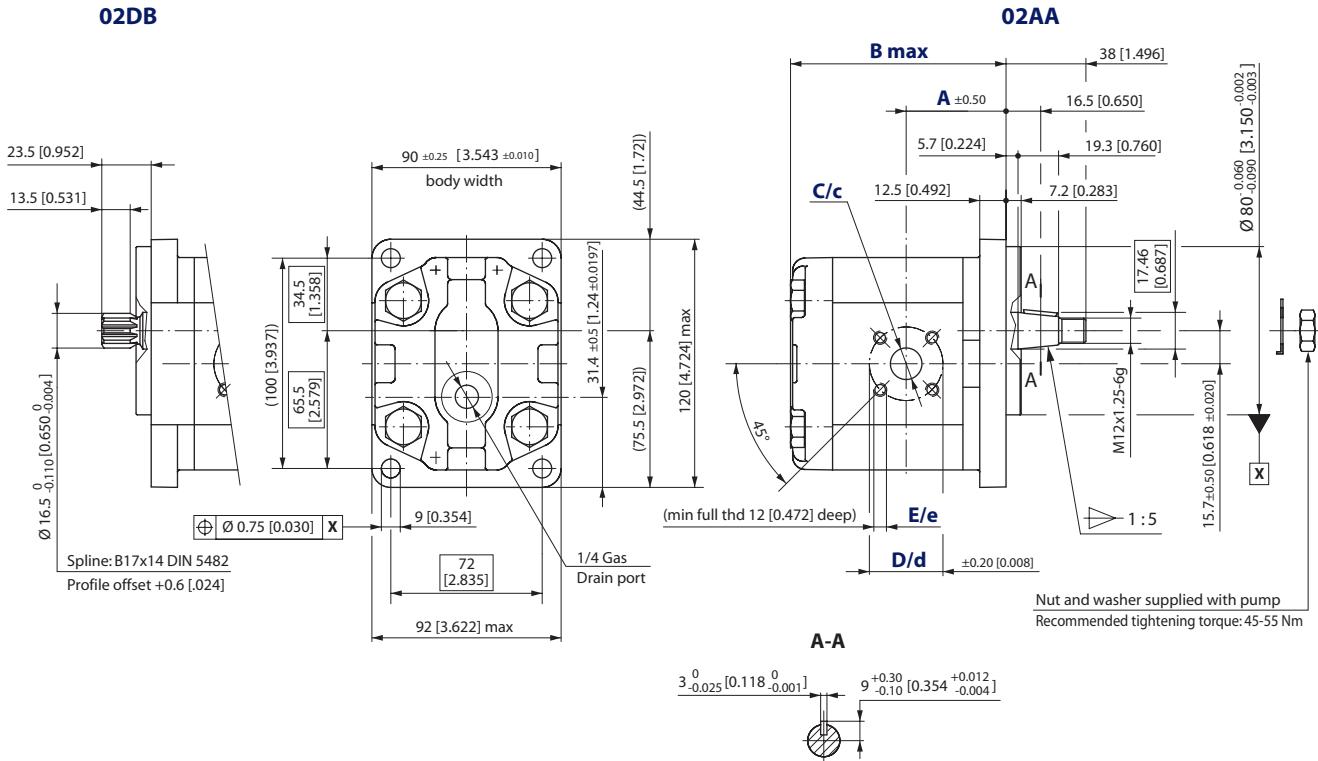

For unidirectional motors no case drain hole into the rear cover.

**Bidirectional motors dimensions – 02DB and 02AA**

Frame size	6,0*	8,0	011	014	017	019	022	025	
Dimension	<b>A</b>	41.1 [1.618]	43.1 [1.697]	47.5 [1.870]	47.5 [1.870]	47.5 [1.870]	47.5 [1.870]	55 [2.165]	64.5 [2.539]
	<b>B</b>	96 [3.780]	100 [3.937]	104 [4.094]	110 [4.331]	114 [4.488]	118 [4.646]	124 [4.882]	128 [5.039]
Inlet/Outlet	<b>C/c</b>	15 [0.591]					20 [0.79]		
	<b>D/d</b>	35 [1.38]					40 [1.58]		
	<b>E/e</b>	M6							

\* Before choosing this frame size, please apply to Turola technical department.

For unidirectional SNU2NN dimensions, see **SNU2NN ports**, page 40.

**Model code examples and maximum shaft torque**

Flange/drive gear	Model code example	Maximum shaft torque
<b>02DB</b>	SNM2NN/025BN02DBM1B7B7NNNN/NNNNN	90 N·m [797 lb·in]
<b>02AA</b>	SNM2NN/8,0BN02AAM1B5B5NNNN/NNNNN	140 N·m [1239 lb·in]

For further details on ordering, see **Model Code**, pages 30-35.





**SNM2NN, SNU2NN – 03CA**  
Standard porting drawing for 03CA

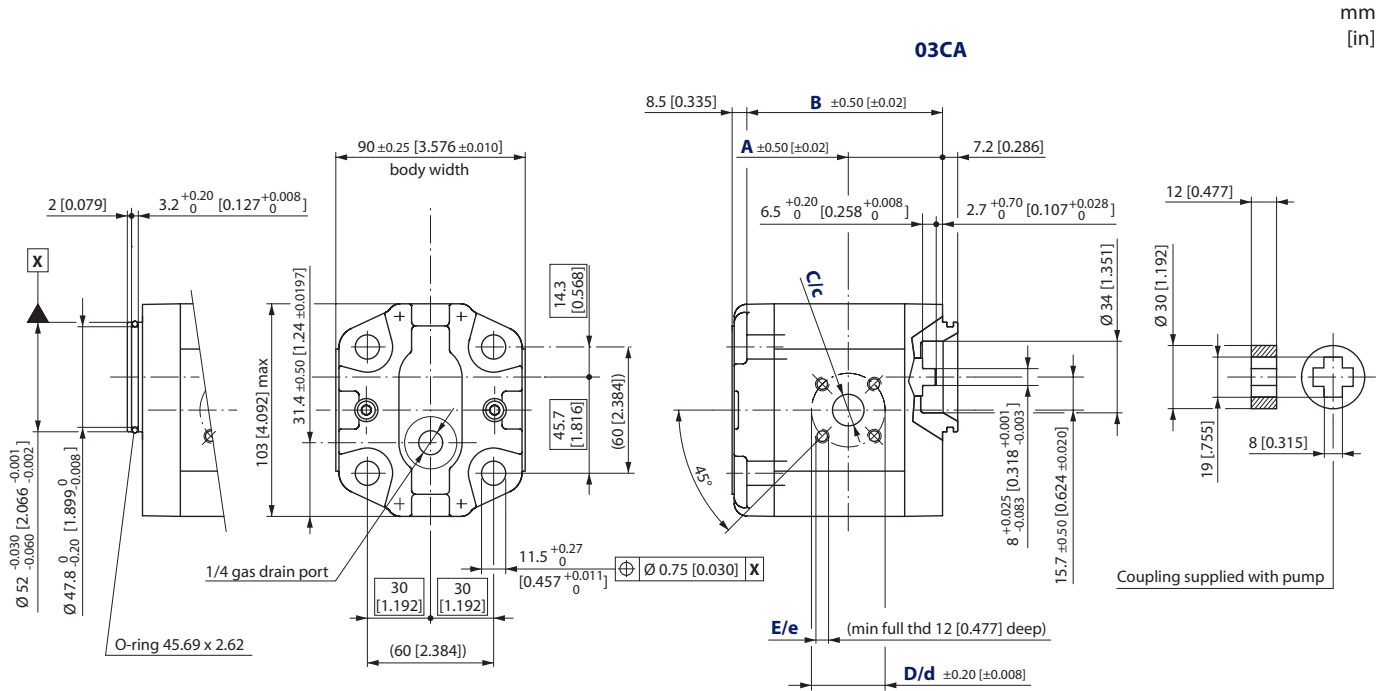

For unidirectional motors no case drain hole into the rear cover.

Bidirectional motors dimensions – 03CA

Frame size	6,0*	8,0	011	014	017	019	022	025	
Dimension	<b>A</b>	38.6 [1.520]	40.6 [1.598]	45 [1.772]			52.5 [2.067]	62 [2.441]	
	<b>B</b>	85 [3.364]	89 [3.503]	93 [3.661]	99 [3.897]	103 [4.055]	107 [4.212]	113 [4.448]	117 [4.606]
Inlet/Outlet	<b>C/c</b>	15 [0.591]					20 [0.79]		
	<b>D/d</b>	35 [1.38]					40 [1.58]		
	<b>E/e</b>	M6							

\* Before choosing this frame size, please apply to Turolla technical department.

For unidirectional SNU2NN dimensions, see [SNU2NN ports](#), page 40.

Model code examples and maximum shaft torque

Flange/drive gear	Model code example	Maximum shaft torque
<b>03CA</b>	SNM2NN/014BN03CAM3B5B5NNNN/NNNNN	70 N·m [620 lb·in]

For further details on ordering, see [Model Code](#), pages 30-35.



**SNM2NN, SNU2NN-04DB/05DB and 04AA/05AA**  
Standard porting drawing for 04DB/05DB and 04AA/05AA

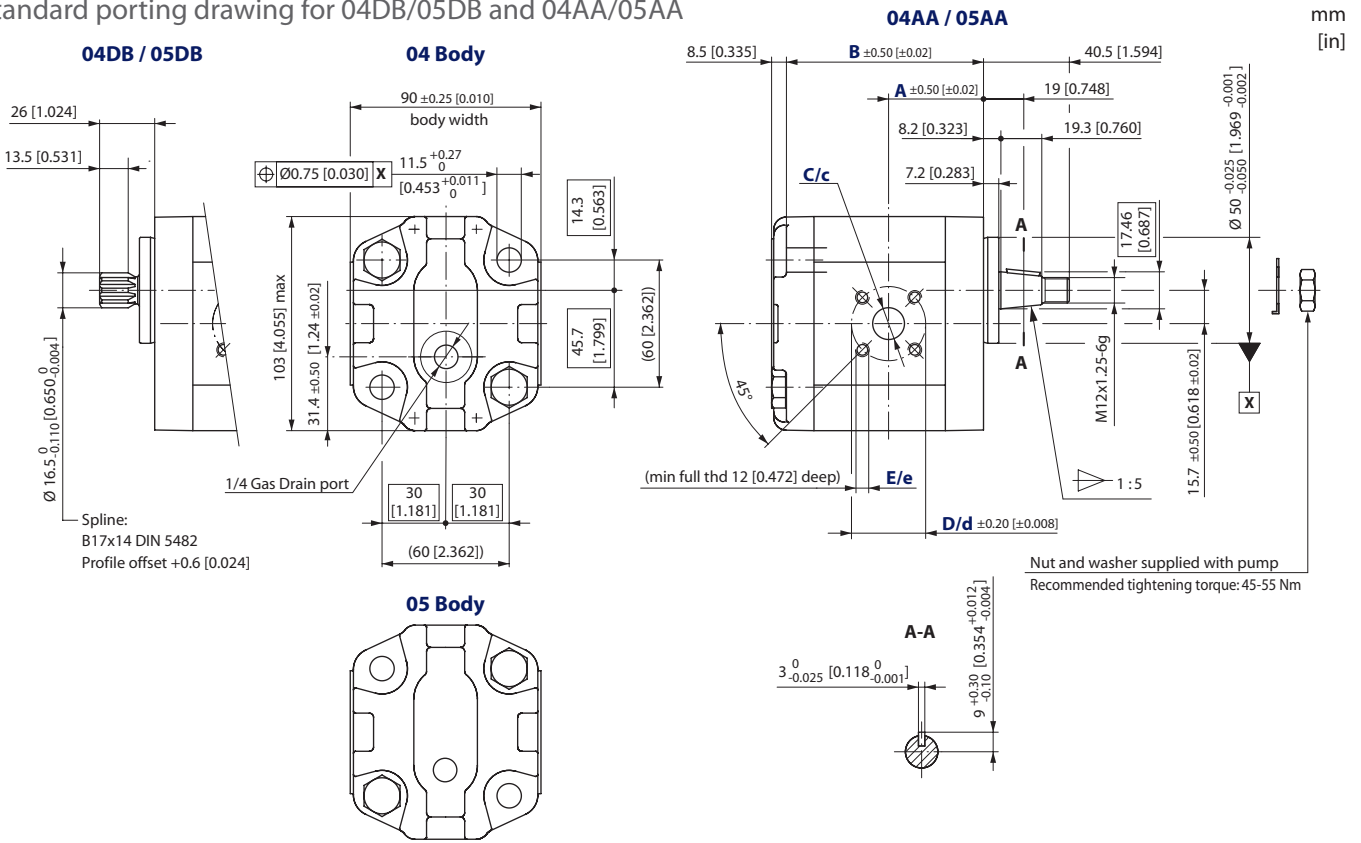

For unidirectional motors no case drain hole into the rear cover.

**Bidirectional motors dimensions – 04/05DB and 04/05AA**

Frame size	6,0*	8,0	011	014	017	019	022	025	
Dimension	<b>A</b>	38.6 [1.520]	40.6 [1.598]	45 [1.772]			52.5 [2.067]	62 [2.441]	
	<b>B</b>	85 [3.364]	89 [3.503]	93 [3.661]	99 [3.897]	103 [4.055]	107 [4.212]	113 [4.448]	117 [4.606]
Inlet/Outlet	<b>C/c</b>	15 [0.591]					20 [0.79]		
	<b>D/d</b>	35 [1.38]					40 [1.58]		
	<b>E/e</b>	M6							

\* Before choosing this frame size, please apply to Turolla technical department.

For unidirectional SNU2NN dimensions, see [SNU2NN ports](#), page 40.

**Model code examples and maximum shaft torque**

Flange/drive gear	Model code example	Maximum shaft torque
<b>04DB</b>	SNM2NN/8,0BN04DBAM1B5B5NNNN/NNNNN	130 N·m [1151 lb·in]
<b>05DB</b>	SNM2NN/017BN05DBM1B5B5NNNN/NNNNN	
<b>04AA</b>	SNM2NN/8,0BN04AAM1B5B5NNNN/NNNNN	140 N·m [1239 lb·in]
<b>05AA</b>	SNM2NN/017BN05AAM1B5B5NNNN/NNNNN	

For further details on ordering, see [Model Code](#), pages 30-35.



**SNM2NN, SNU2NN, SKU2NN – 06SA, 06GA**

Standard porting drawing for 06SA and 06GA

mm  
[in]

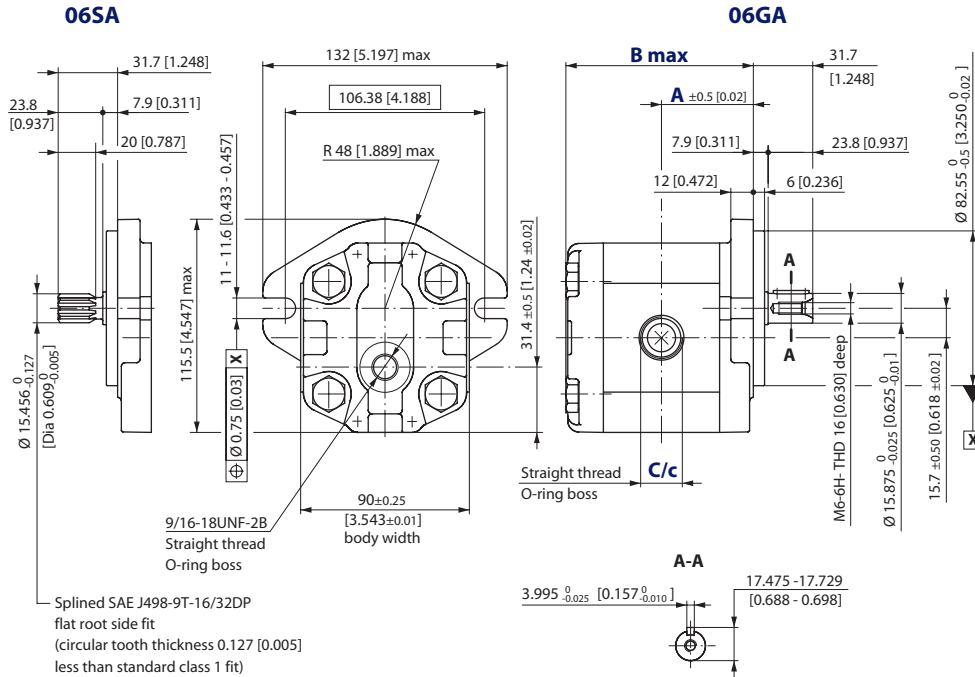

For unidirectional motors no case drain hole into the rear cover.

**Bidirectional motors dimensions – 06SA and 06GA**

Frame size	6,0*	8,0	011	014	017	019	022	025	
Dimension	A	45 [1.772]	47 [1.850]	49 [1.920]	52 [2.047]	54 [2.205]	56 [2.205]	59 [2.323]	61 [2.402]
	B	93.5 [3.681]	97.5 [3.839]	101.5 [3.996]	107.5 [4.232]	111.5 [4.390]	115.5 [4.547]	121.5 [4.783]	125.5 [4.941]
Inlet/Outlet	C/c 7/8-14UNF-2B, 16.7 [0.658] deep					1 1/16-12UNF-2B, 18.0 [0.709] deep			

\* Before choosing this frame size, please apply to Turolla technical department.

For unidirectional SNU2NN dimensions, see [SNU2NN ports](#), page 40.

**Model code examples and maximum shaft torque**

Flange/drive gear	Model code example	Maximum shaft torque
06SA	SNM2NN/8,0BN06SAM1E5E5NNNN/NNNNN	75 N·m [664 lb·in]
06GA	SNM2NN/017BN06GAM6E5E5NNNN/NNNNN	80 N·m [708 lb·in]

For further details on ordering, see [Model Code](#), pages 30-35.



## GROUP 3 GEAR MOTORS

### Motor design

#### SNM3NN

SNM3NN is the Group 3 bidirectional motor available in the whole displacements range from 22 up to 90 cm<sup>3</sup>/rev [1.35 up to 5.38 in<sup>3</sup>/rev].

Configurations include European and SAE flanges and shafts (01BA, 01FA, 01DA, 02AA, 02FA, 02DB, 03BB, 03FB, 06AA, 06DD, 07BC, 07GA, 07SA).

#### SNU3NN

SNU3NN is the Group 3 unidirectional motor available in the whole displacements range from 22 up to 90 cm<sup>3</sup>/rev [1.35 up to 5.38 in<sup>3</sup>/rev].

The SNU3NN motor construction is derived from the correspondent pump SNP3.

Configurations include European and SAE flanges and shafts (01BA, 01FA, 01DA, 02AA, 02FA, 02DB, 03BB, 03FB, 03DB, 06AA, 06SA, 07BC, 07GA, 07SA).

SNM3NN 01BA

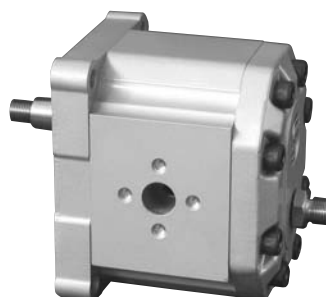

SNU3NN 01BA (cut away)

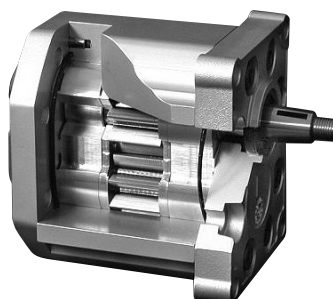



## Technical data

This table details the technical data for Group 3 gear motors based on the model and displacement configuration.

Technical data for Group 3 gear motors

		Frame size									
		022	026	033	038	044	048	055	063	075	090
Displacement	cm <sup>3</sup> /rev [in <sup>3</sup> /rev]	22.1 [1.35]	26.2 [1.60]	33.1 [2.02]	37.9 [2.32]	44.1 [2.69]	48.3 [2.93]	55.2 [3.36]	63.4 [3.87]	74.4 [4.54]	88.2 [5.38]
<b>SNU3NN (unidirectional)</b>											
Peak pressure	bar [psi]	270 [3915]	270 [3915]	270 [3915]	270 [3915]	270 [3915]	250 [3625]	230 [3336]	210 [3045]	190 [2755]	170 [2465]
Rated pressure		250 [3625]	250 [3625]	250 [3625]	250 [3625]	250 [3625]	230 [3336]	210 [3045]	190 [2755]	170 [2465]	150 [2175]
Minimum speed	min <sup>-1</sup> (rpm)	800	800	800	800	800	800	800	600	600	600
Maximum speed		2500	2500	2500	2500	2300	2300	2300	2300	2100	2100
<b>SNM3NN (bidirectional) motor in parallel</b>											
Peak pressure	bar [psi]	270 [3915]	270 [3915]	270 [3915]	270 [3915]	270 [3915]	250 [3625]	230 [3336]	210 [3045]	190 [2755]	170 [2465]
Rated pressure		250 [3625]	250 [3625]	250 [3625]	250 [3625]	250 [3625]	230 [3336]	210 [3045]	190 [2755]	170 [2465]	150 [2175]
Minimum speed	min <sup>-1</sup> (rpm)	800	800	800	800	800	800	800	800	800	800
Maximum speed		2500	2500	2500	2500	2300	2300	2300	2300	2100	2100
<b>SNM3NN (bidirectional) motor in series</b>											
Peak pressure	bar [psi]	250 [3625]	250 [3625]	250 [3625]	250 [3625]	250 [3625]	230 [3336]	210 [3045]	190 [2755]	170 [2465]	150 [2175]
Rated pressure		250 [3625]	250 [3625]	250 [3625]	250 [3625]	250 [3625]	230 [3336]	210 [3045]	190 [2755]	170 [2465]	150 [2175]
Minimum speed	min <sup>-1</sup> (rpm)	800	800	800	800	800	800	800	800	800	800
Maximum speed		2500	2500	2500	2500	2300	2300	2200	2100	2100	2100
<b>All (SNU3NN, SNM3NN)</b>											
Weight	kg [lb]	6.8 [15.0]	6.8 [15.0]	7.2 [15.8]	7.3 [16.1]	7.5 [16.5]	7.6 [16.8]	7.8 [17.3]	8.1 [17.9]	8.5 [18.7]	8.9 [19.6]
Moment of inertia of rotating components	x 10 <sup>-6</sup> kg·m <sup>2</sup> [x 10 <sup>-6</sup> lb·ft <sup>2</sup> ]	198 [4698]	216 [5126]	246 [5837]	267.2 [6341]	294.2 [6981]	312.2 [7408]	342.3 [8123]	378.3 [8977]	426.4 [10 118]	486.5 [11 545]

1 kg·m<sup>2</sup> = 23.68 lb·ft<sup>2</sup>

### ! Caution

The rated and peak pressure mentioned are for motors with flanged ports only. When threaded ports are required a derated performance has to be considered. To verify the compliance of an high pressure application with a threaded ports pump apply to a Turolla representative.



## Product Code Model Code

A	B	C	D	E	F	G	H	I	J	K	L	M	N	O
<input type="text"/>	<input type="text"/>	<input type="text"/>	<input type="text"/>	<input type="text"/>	<input type="text"/>	<input type="text"/>	<input type="text"/>	<input type="text"/>	<input type="text"/>	<input type="text"/>	<input type="text"/>	<input type="text"/>	<input type="text"/>	<input type="text"/>

### A Family

<b>SEU3NN</b>	Low Cost Gr3 Unidirecional Motor
<b>SNU3NN</b>	Gr3 Unidirectional Motor
<b>SNU3GN</b>	Gr3 Unidirectional Motor+Anticav.Check Valve
<b>SNM3NN</b>	Gr3 Bidirectional Motor - Axial drain on cover
<b>SNM3NL</b>	Gr3 Bidirectional Motor-Vert.drain on rear cover
<b>SNM3GN</b>	Gr3 Bidirectional Motor-Anticav.Check Valve - Axial drain on cover
<b>SNM3GL</b>	Gr3 Bidirectional Motor-Anticav.Check Valve - Vert.drain on rear cover
<b>SNM3CN</b>	Gr3 Bidirectional Motor-Anticav.Check valve on Cover
<b>SNM3DN</b>	Gr3 Bidirectional Motor-Internal drain valve

### B Displacement

<b>022</b>	22,1 cc
<b>026</b>	26,2 cc
<b>033</b>	33,1 cc
<b>038</b>	37,9 cc
<b>044</b>	44,1 cc
<b>048</b>	48,3 cc
<b>055</b>	55,2 cc
<b>063</b>	63,4 cc
<b>075</b>	74,4 cc
<b>090</b>	88,2 cc

### C Rotation

<b>B</b>	Bidirectional
<b>L</b>	Left rotation
<b>R</b>	Right rotation



## D Project version (value representing a change to the initial project)

N	Std Version of Project
---	------------------------

## E Mounting flange

Code	Description (Type of flange • Type of drive gear • Preferred ports for configuration)
01	Pilot Ø50,8+4 holes (98,4x128,1)
02	Pilot Ø50,8+4 holes (98,4x137)
03	Pilot Ø60,3+4 holes (114,3x149,5)
06	Pilot Ø105+4 holes (102,0x145,0)
07	SAE B-pilot Ø101,6 -2 holes
08	SAE C-pilot Ø127 -4 holes
09	SAE A-pilot Ø82,55 -2 holes
91	Outrigger bearing typo 01 -Taper 1:8 M14x1,5 key 4x7,5
9Y	Outrigger bearing type 07 -taper shaft 1:8-5/8-18UNF-Key6,375 with Dust Cover
B1	Pilot Ø50,8+4 holes special shaft seal slot - Special 01
D6	Pilot Ø105+4 holes + shaft seal D40 per shaft spline - Special 06
D7	Pilot Ø101,6+2 holes + double shaft seal - Special 07
P1	Pilot Ø50,8+4 holes Ø12-12,5 - Special 01
P7	Pilot Ø101,6+2 fixed holes slot - Special 07

## F Drive gear

AA	Taper 1:5-M16x1,5-Key 5
BA	Taper 1:8-M14x1,5-Key 4
BB	Taper 1:8-M16x1,5-Key 4,79
BC	Taper 1:8-5/8-18UNF-2A-Key 6,375
BD	Taper 1:8-M14x1,5-Key 4 + thd hole M8 - Special
BP	Taper 1:8-5/8-18UNF-2A-Key 6,375 with NUT & WASHER (for flange 07)
CA	Tang 8xØ22,2 - Special
CB	Tang 12xØ24-shaft flange protrusion sb17.5-dr72.5-Special
DA	DIN 5482 B22x19 L=24 (for flange typo 01)
DD	DIN 5482 B28x25 L28 (for flange typo 06)
FA	Parallel Ø20-Key 5x5 L30 (for flange typo 01-02)
FB	Parallel Ø22-Key 5x5 L40 (for flange typo 03)
GA	Parallel Ø22,225 x L25,4-Key 6,375x6,375 L25,4
GB	Parallel Ø22,225xL25,4-Key 6,375x6,375x25,4+thd hole:1/4-20UNC-2B
GC	Parallel Ø22,225xL25,4-Key 6,375x6,375x25,4+thd hole:5/16-18UNC-2B - Special
SA	SAE J498-13T-16/32-SAE B
SB	SAE J498-13T-16/32-SAE A (for flange typo 09)
RA	SAE J498-14T-12/24-SAE C-4 bolt (for flange typo 08)
SH	SAE J498-15T-16/32-(for flange typo 07)

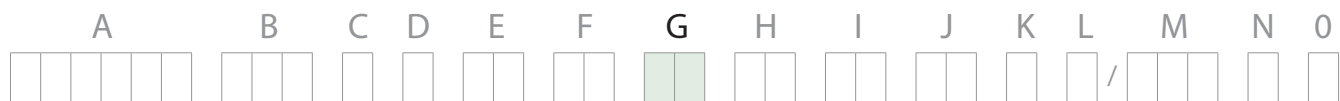

## G Rear cover

<b>P1</b>	Std cover for unidirectional motors
<b>M1</b>	Std cover motor axial drain on cover M14x1,5
<b>M2</b>	Std cover motor axial drain on cover M12x1,5 ISO6149
<b>M6</b>	Std cover motor axial drain on cover 9/16-18UNF-2B
<b>MF</b>	Std cover motor axial drain on cover drain 3/8 Gas
<b>L1</b>	Cover motor with radial drain on cover - Vertical M14x1,5
<b>L2</b>	Cover motor with radial drain on cover - Horizontal M14x1,5
<b>L6</b>	Cover motor with radial drain on cover - Vertical 9/16-18UNF-2B
<b>LT</b>	Cover motor with radial drain on cover - Vertical 9/16-18UNF-2B drain up
<b>C1</b>	Cover motor with front metric ports : M22x1,5 - for SNM3CN series
<b>D1</b>	Cover motor without drain (internal drained) - for SNM3DN series





## H Inlet size I Outlet size

<b>A2</b>	18,5x22,23x47,63x3/8-16UNC		<b>M5</b>	25x52,37x26,19xM10	
<b>A3</b>	25x26,19x52,37x3/8-16UNC		<b>M6</b>	31x30,18x58,72xM10	
<b>A4</b>	31x30,18x58,72x7/16-14UNC		<b>M7</b>	37,5x35,71x69,85xM12	
<b>A5</b>	37,5/27x35,71x69,85x1/2-13UNC		<b>MF</b>	25x52,37x26,19xM8 deep12 Horiz	
<b>B7</b>	20x40xM6		<b>MG</b>	25/20x52,37x26,19xM10(=) - Special	
<b>BA</b>	18x55xM8		<b>MH</b>	31x30,18x58,72xM10 deep18(=)	
<b>BB</b>	27x55xM8		<b>MN</b>	31x30,18x58,72xM10 deep12(=)	
<b>BC</b>	36/27x55xM8		<b>MR</b>	37,5x35,71x69,85xM12 deep20(=)	
<b>C3</b>	13,5x30xM6				
<b>C7</b>	20x40xM8				
<b>CA</b>	27x51xM10				
<b>CD</b>	36x62xM10				
<b>CZ</b>	27x51xM10(2 Vert.Holes)				
<b>G7</b>	20x40x5/16-18UNC - Special				
<b>GA</b>	27x51x3/8-16UNC - Special				
<b>E5</b>	7/8-14UNF				
<b>E6</b>	1-1/16-12UN				
<b>E8</b>	1-5/16-12UN				
<b>E9</b>	1-5/8-12UN				
<b>EA</b>	1-7/8-12UN				
<b>H8</b>	M27x2-ISO6149				
<b>H9</b>	M33x2-ISO6149				
<b>F5</b>	BSP 3/4 GAS				
<b>F6</b>	BSP 1 GAS				
<b>F7</b>	BSP 1-1/4 GAS				



## J Ports Pos & Spec Body

<b>NN</b>	Std from catalogue
<b>*PL</b>	Inlet port Left position looking gear drive from front flange
<b>*PR</b>	Inlet port Right position looking gear drive from front flange
<b>ZZ</b>	Port Bx-Bx in the center of the body - Option

\* to be used if inlet-outlet are different

## K Seals

<b>N</b>	Standard NBR seals
<b>B</b>	VITON seals - Option
<b>D</b>	NBR seals + VITON shaft seal with dust lip
<b>X</b>	NBR seals + Dust Cover - Option
<b>Y</b>	VITON seals + Dust Cover - Option
<b>Z</b>	VITON shaft seal + Dust Cover - Option

## L Screws

<b>N</b>	Std burnished screws
<b>B</b>	Dacromet/Geomer - Anticorrosion screws

## M Set valves

<b>NNN</b>	No valve
------------	----------

## N Type of mark

<b>N</b>	Standard Turolla Marking
<b>A</b>	Standard Turolla Marking+Customer Code-Special
<b>Z</b>	Without Marking

## O Mark position

<b>N</b>	Std Marking position (on top)
<b>A</b>	Special Marking position on the bottom



### Motor performance graphs

The graphs on the next pages provide typical inlet flow and output power for Group 3 motors at various working pressures. Data were taken using ISO VG46 petroleum /mineral based fluid at 50 °C [122 °F] (viscosity = 28 mm<sup>2</sup>/s [132 SUS]).

SNM3NN/022 motor performance graph

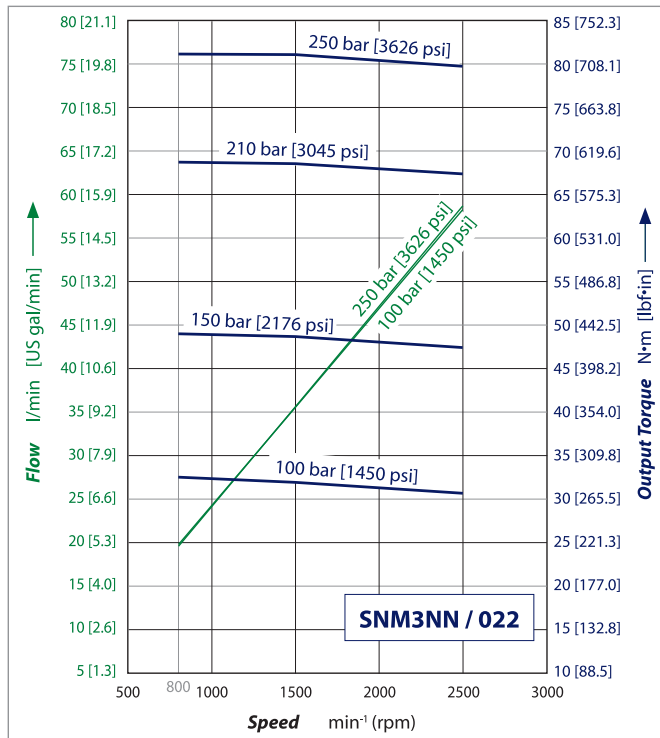

SNM3NN/026 motor performance graph

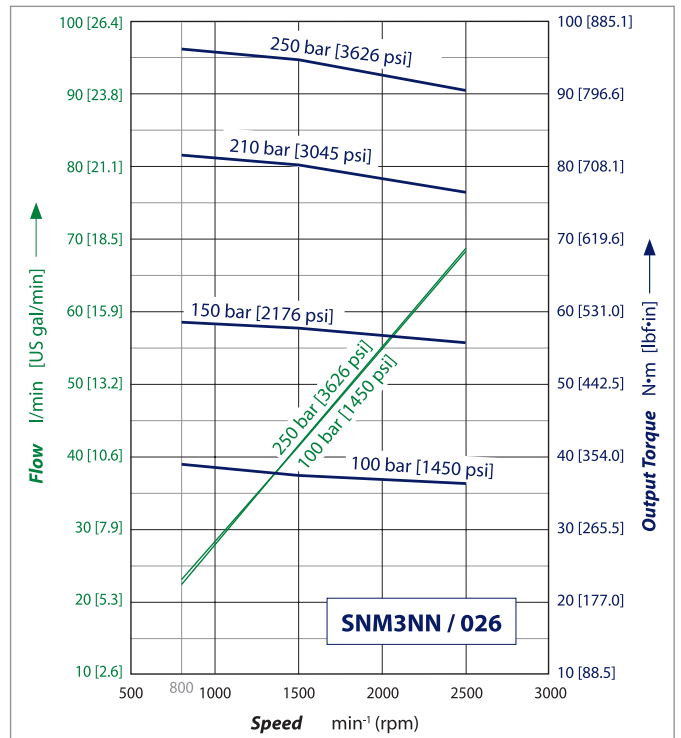

SNM3NN/033 motor performance graph

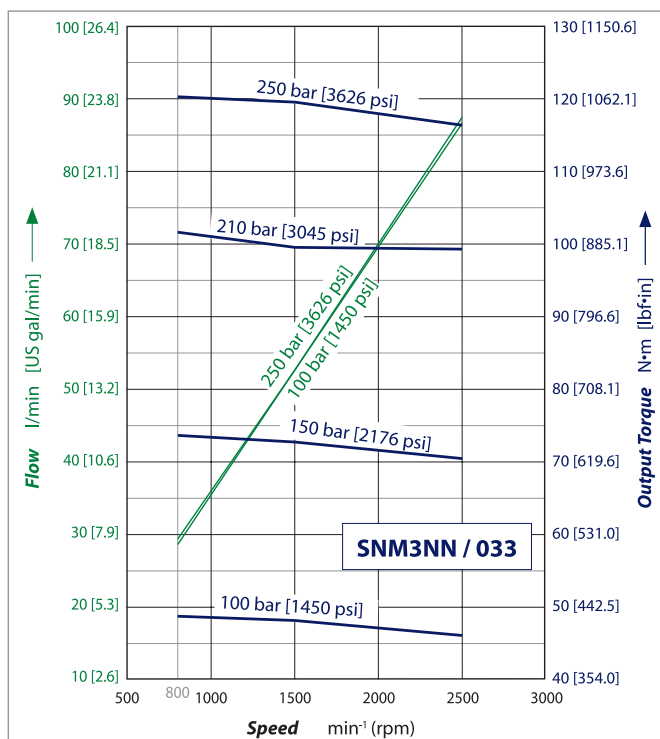

SNM3NN/038 motor performance graph

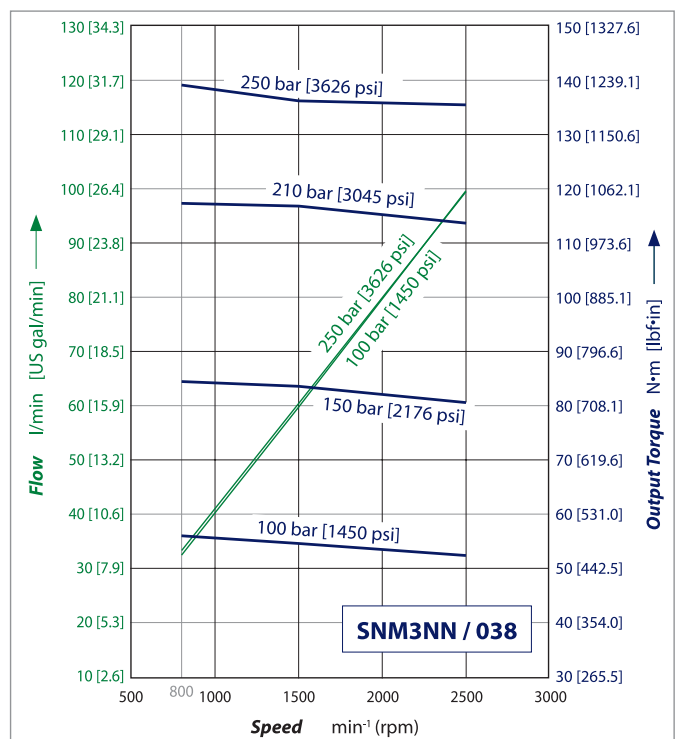



SNM3NN/044 motor performance graph

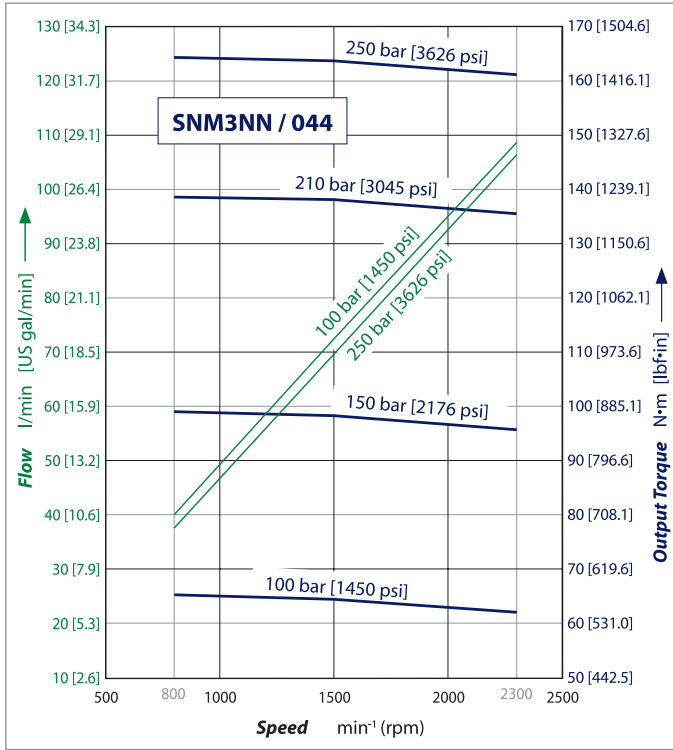

SNM3NN/048 motor performance graph

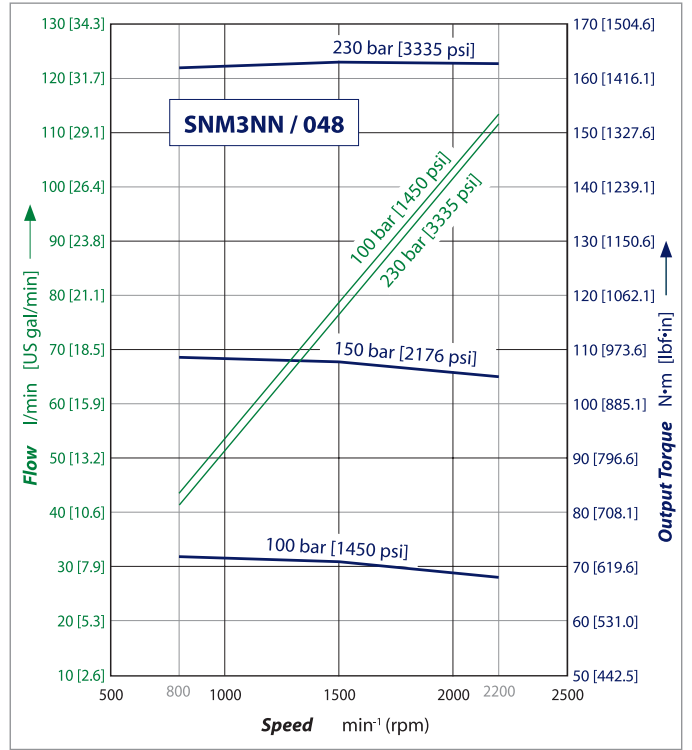

SNM3NN/055 motor performance graph

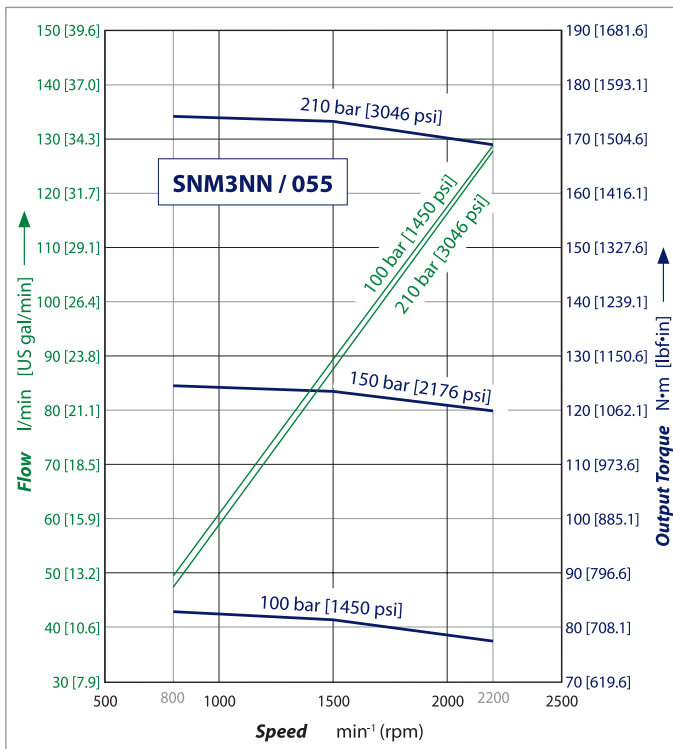

SNM3NN/063 motor performance graph

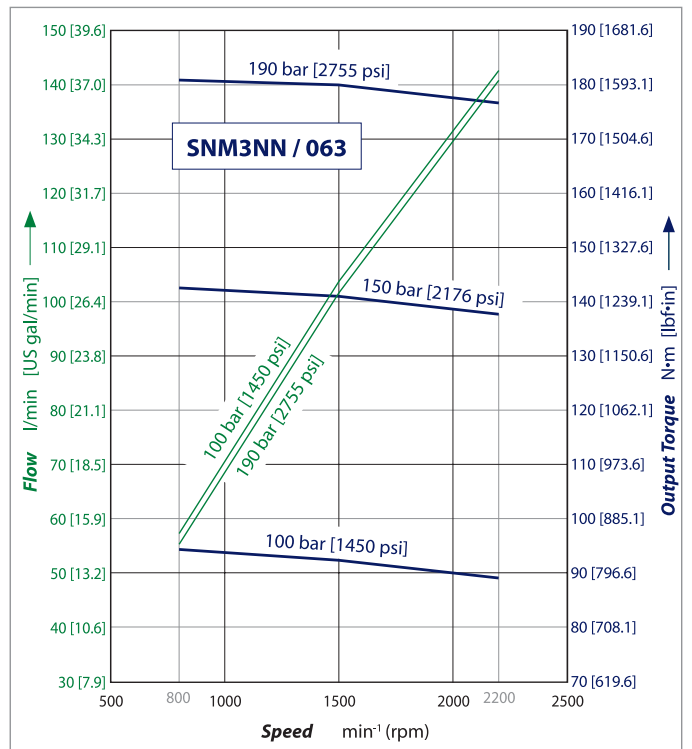



SNM3NN/075 motor performance graph

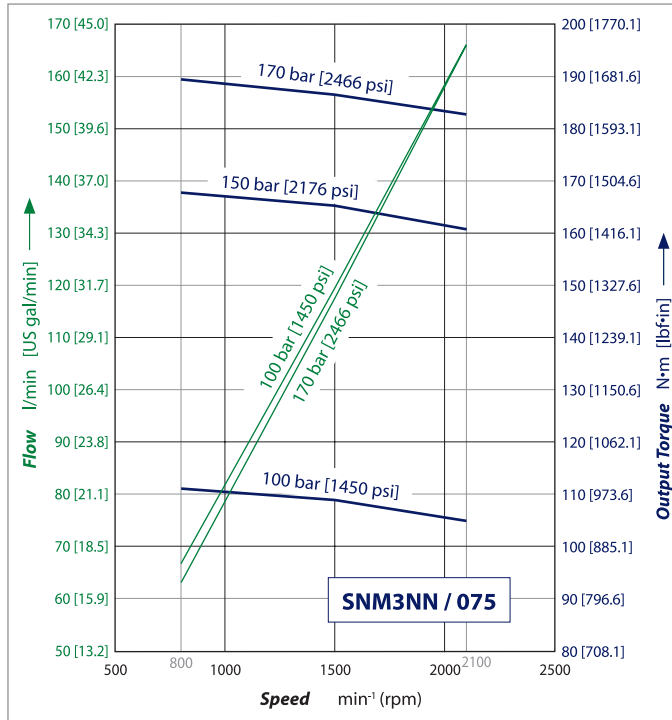

SNM3NN/090 motor performance graph

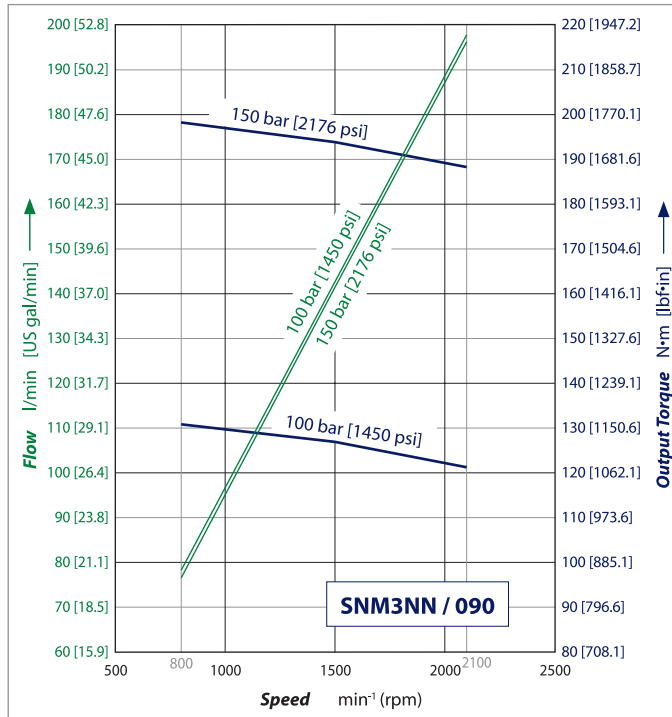



## Flange, shaft and port configurations

Motor	Code	Flange	Shaft	Port
SNM3NN SNU3NN SNM3GN	<b>01BA</b>	pilot Ø 50.8 mm [2.0 in] European 01 4-bolt	1:8 tapered	European flanged port + pattern
SNM3NN SNU3NN SNM3GN	<b>02BA</b>	pilot Ø 50.8 mm [2.0 in] European 02 4-bolt	1:8 tapered	European flanged port + pattern
SNM3NN SNU3NN SNM3GN	<b>03BB</b>	pilot Ø 60.3 mm [2.374 in] European 03 4-bolt	1:8 tapered	European flanged port + pattern
SNM3NN SNU3NN SNM3GN	<b>06AA</b>	pilot Ø 105 mm [4.133 in] German 4-bolt	1:5 tapered	German std ports port X pattern
SNM3NN SNU3NN SNM3GN	<b>07BC</b>	SAE B pilot Ø 101.6 2-bolt	1:8 tapered	Vertical four bolt flanged port
SNM3NN SNU3NN SNM3GN	<b>01FA</b>	pilot Ø 50.8 mm [2.0 in] European 01 4-bolt	Ø 20 mm [0.787 in] parallel	European flanged port + pattern
SNM3NN SNU3NN SNM3GN	<b>02FA</b>	pilot Ø 50.8 mm [2.0 in] European 02 4-bolt	Ø 20 mm [0.787 in] parallel	European flanged port + pattern
SNM3NN SNU3NN SNM3GN	<b>03FB</b>	pilot Ø 60.3 mm [2.374 in] European 03 4-bolt	Ø 22 mm [0.866 in] parallel	European flanged port + pattern
SNM3NN SNU3NN SNM3GN	<b>07GA</b>	SAE B pilot Ø 101.6 mm 2-bolt	Ø 22.225 mm [0.875 in] parallel	Vertical four bolt flanged port
SNM3NN SNU3NN SNM3GN	<b>01DA</b>	pilot Ø 50.8 mm [2.0 in] European 01 4-bolt	Splined shaft 13T – m 1.60 DIN 5482 – B22 x 19	European flanged port + pattern
SNM3NN SNU3NN SNM3GN	<b>02DB</b>	pilot Ø 50.8 mm [2.0 in] European 02 4-bolt	Splined shaft 13T – m 1.60 DIN 5482 – B22 x 19	European flanged port + pattern
SNM3NN SNU3NN SNM3GN	<b>06DD</b>	pilot Ø 105 mm [4.133 in] German 4-bolt	Splined shaft 15T – m 1.60 DIN 5482 – B28 x 25	German std ports port X pattern
SNM3NN SNU3NN SNM3GN	<b>07SA</b>	SAE B pilot Ø 101.6 mm 2-bolt	Splined shaft SAE J498 13T – 16/32DP	Vertical four bolt flanged port



## Shaft and flange availability and torque capability

This table details the standard Group 3 shafts and flange combinations that are currently available with the maximum shaft torque limits.

### Shaft and flange availability and torque capability

Shaft		Mounting flange code with maximum torque in Nm [lb-in]				
Code	Description	01	02	03	06	07
AA	Taper 1:5-M16x1,5-Key 5				300 [2655]	
BA	Taper 1:8-M14x1,5-Key 4	350 [3097]	350 [3097]			
BB	Taper 1:8-M16x1,5-Key 4,79			500 [4425]		
BC	Taper 1:8-5/8-18UNF-2A-Key 6,375					300 [2655]
BD	Taper 1:8-M14x1,5-Key 4 + thd hole M8 - Special	350 [3097]	350 [3097]			
BP	"Taper 1:8-5/8-18UNF-2A-Key 6,375					300 [2655]
CA	with Nut & Washer (for flange 07)"					**
CB	Tang 8xØ22,2 - Special			**		
DA	Tang 12xØ24 - Special	290 [2566]	290 [2566]			
DD	DIN 5482 B22x19 L24 (for flange typo 01)				450 [3982]	
FA	DIN 5482 B28x25 L28 (for flange typo 06)	210 [1858]	210 [1858]			
FB	Parallel Ø20-Key 5x5 L30 (for flange typo 01-02)			300 [2655]		
GA	Parallel Ø22-Key 5x5 L40 (for flange typo 03)					230 [2035]
GB	Parallel Ø22,225 x L25,4-Key 6,375x6,375 L25,4					230 [2035]
GC	"Parallel Ø22,225xL25,4-Key 6,375x6,375x25,4					230 [2035]
SA	with thd hole:1/4-20UNC-2B "					270 [2389]
SB	"Parallel Ø22,225xL25,4-Key 6,375x6,375x25,4					270 [2389]
RA	with thd hole:5/16-18UNC-2B - Special"					400 [3540]
SH	SAE J498-13T-16/32-SAE B					400 [3540]



## Ports dimensions

### Bidirectional motor ports

Available ports for Group 3 bidirectional motors

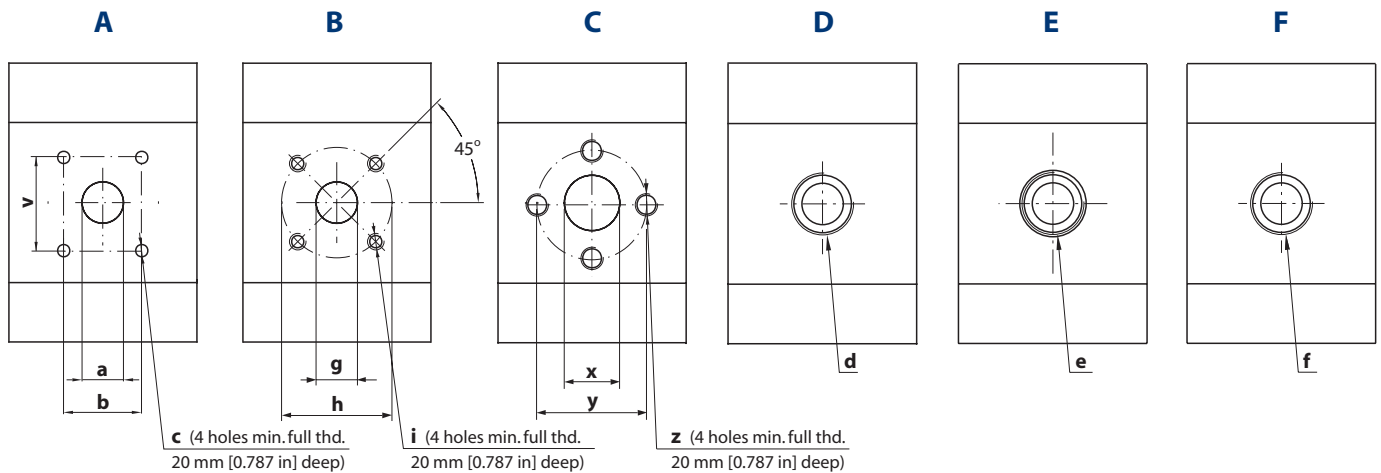

### Ports dimensions for bidirectional motors SNM3NN

Port type	A			B			C			D	E	F	
Dimensions	a	b	v	c	g	h	i	x	y	z	d	e	f
Frame size	022	25.4 [1.0]	26.19 [1.031]	52.37 [2.061]	$\frac{3}{8}$ -16UNC-2B	27 [1.063]	55 [2.165]	M8	20 [0.79]	40 [1.58]	M8	M26x1.5	$\frac{3}{4}$ Gas (BSPP)
	026	25.4 [1.0]	26.19 [1.031]	52.37 [2.061]	$\frac{3}{8}$ -16UNC-2B	27 [1.063]	55 [2.165]	M8	20 [0.79]	40 [1.58]	M8	M26x1.5	$\frac{3}{4}$ Gas (BSPP)
	033	31.8 [1.251]	30.18 [1.188]	58.72 [2.311]	$\frac{7}{16}$ -14UNC-2B	27 [1.063]	55 [2.165]	M8	27 [1.063]	51 [2.008]	M10	M33x2	1 Gas (BSPP)
	038	31.8 [1.251]	30.18 [1.188]	58.72 [2.311]	$\frac{7}{16}$ -14UNC-2B	27 [1.063]	55 [2.165]	M8	27 [1.063]	51 [2.008]	M10	M33x2	1 Gas (BSPP)
	044	31.8 [1.251]	30.18 [1.188]	58.72 [2.311]	$\frac{7}{16}$ -14UNC-2B	27 [1.063]	55 [2.165]	M8	27 [1.063]	51 [2.008]	M10	M33x2	1 Gas (BSPP)
	048	31.8 [1.251]	30.18 [1.188]	58.72 [2.311]	$\frac{7}{16}$ -14UNC-2B	27 [1.063]	55 [2.165]	M8	27 [1.063]	51 [2.008]	M10	M33x2	1 Gas (BSPP)
	055	31.8 [1.251]	30.18 [1.188]	58.72 [2.311]	$\frac{7}{16}$ -14UNC-2B	27 [1.063]	55 [2.165]	M8	27 [1.063]	51 [2.008]	M10	M33x2	1 Gas (BSPP)
	063	31.8 [1.251]	30.18 [1.188]	58.72 [2.311]	$\frac{7}{16}$ -14UNC-2B	36 [1.417]	55 [2.165]	M8	36 [1.417]	62 [2.441]	M10	M33x2	$1\frac{1}{4}$ Gas (BSPP)
	075	31.8 [1.251]	30.18 [1.188]	58.72 [2.311]	$\frac{7}{16}$ -14UNC-2B	36 [1.417]	55 [2.165]	M8	36 [1.417]	62 [2.441]	M10	M33x2	$1\frac{1}{4}$ Gas (BSPP)
	090	31.8 [1.251]	30.18 [1.188]	58.72 [2.311]	$\frac{7}{16}$ -14UNC-2B	36 [1.417]	55 [2.165]	M8	36 [1.417]	62 [2.441]	M10	M33x2	$1\frac{1}{4}$ Gas (BSPP)
Drain	M14 x 1.5										$\frac{1}{16}$ -18UNF-2B		





## Unidirectional motor ports

Available ports for Group 3 unidirectional motors

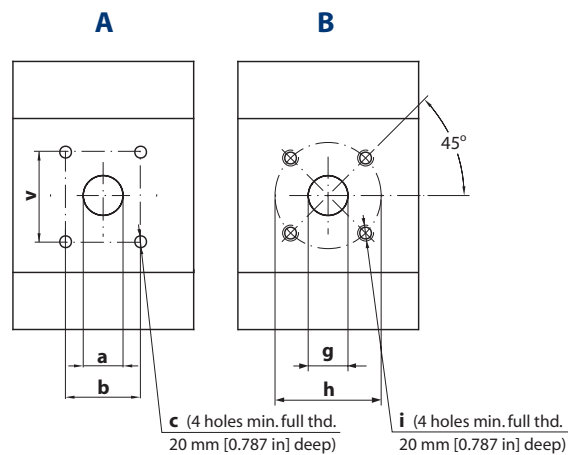

Ports dimensions for unidirectional motors SNU3NN

Port type		A				B			
Dimensions		a	b	c	v	g	h	i	
Frame size	022	Outlet	20 [0.79]	40 [1.58]	M8	3/8-16UNC-2B	27 [1.063]	55 [2.165]	M8
		Inlet	20 [0.79]	40 [1.58]	M8	3/8-16UNC-2B	18 [0.709]	55 [2.165]	M8
	026	Outlet	20 [0.79]	40 [1.58]	M8	3/8-16UNC-2B	27 [1.063]	55 [2.165]	M8
		Inlet	20 [0.79]	40 [1.58]	M8	3/8-16UNC-2B	18 [0.709]	55 [2.165]	M8
	033	Outlet	27 [1.063]	51 [2.008]	M10	7/16-14UNC-2B	27 [1.063]	55 [2.165]	M8
		Inlet	20 [0.79]	40 [1.58]	M8	3/8-16UNC-2B	18 [0.709]	55 [2.165]	M8
	038	Outlet	27 [1.063]	51 [2.008]	M10	7/16-14UNC-2B	27 [1.063]	55 [2.165]	M8
		Inlet	20 [0.79]	40 [1.58]	M8	3/8-16UNC-2B	18 [0.709]	55 [2.165]	M8
	044	Outlet	27 [1.063]	51 [2.008]	M10	7/16-14UNC-2B	27 [1.063]	55 [2.165]	M8
		Inlet	27 [1.063]	51 [2.008]	M10	3/8-16UNC-2B	18 [0.709]	55 [2.165]	M8
	048	Outlet	27 [1.063]	51 [2.008]	M10	7/16-14UNC-2B	27 [1.063]	55 [2.165]	M8
		Inlet	27 [1.063]	51 [2.008]	M10	3/8-16UNC-2B	18 [0.709]	55 [2.165]	M8
	055	Outlet	27 [1.063]	51 [2.008]	M10	1/2-13UNC-2B	27 [1.063]	55 [2.165]	M8
		Inlet	27 [1.063]	51 [2.008]	M10	7/16-14UNC-2B	18 [0.709]	55 [2.165]	M8
	063	Outlet	36 [1.417]	62 [2.441]	M10	1/2-13UNC-2B	36 [1.417]	55 [2.165]	M8
		Inlet	27 [1.063]	51 [2.008]	M10	7/16-14UNC-2B	27 [1.063]	55 [2.165]	M8
075	Outlet	36 [1.417]	62 [2.441]	M10	1/2-13UNC-2B	36 [1.417]	55 [2.165]	M8	
	Inlet	27 [1.063]	51 [2.008]	M10	7/16-14UNC-2B	27 [1.063]	55 [2.165]	M8	
090	Outlet	36 [1.417]	62 [2.441]	M10	1/2-13UNC-2B	36 [1.417]	55 [2.165]	M8	
	Inlet	27 [1.063]	51 [2.008]	M10	7/16-14UNC-2B	27 [1.063]	55 [2.165]	M8	

(the table is continued on the next page)



## Unidirectional motor ports

Available ports for Group 3 unidirectional motors

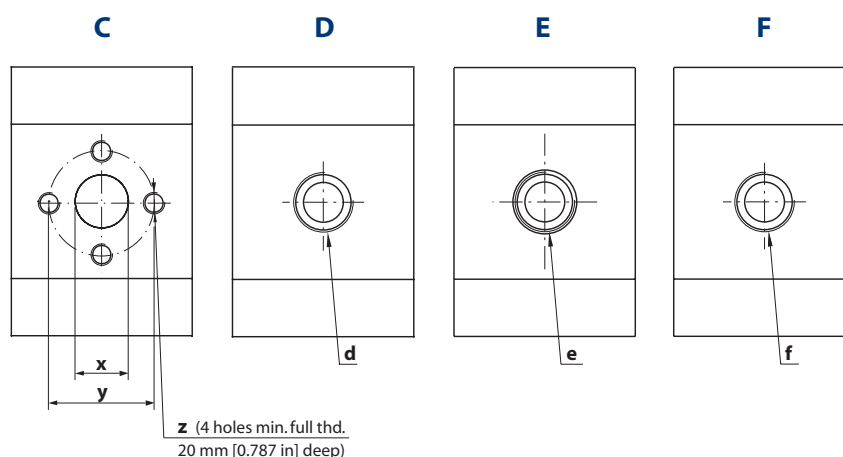

Ports dimensions for unidirectional motors SNU3NN

Port type		C			D	E	F	
Dimensions		x	y	z	d	e	f	
Frame size	022	Outlet	20 [0.79]	40 [1.58]	M8	M26 x 1.5	¾ Gas (BSPP)	1 <sup>5</sup> / <sub>16</sub> -12UN-2B
		Inlet	20 [0.79]	40 [1.58]	M8	M26 x 1.5	¾ Gas (BSPP)	1 <sup>1</sup> / <sub>16</sub> -12UN-2B
	026	Outlet	20 [0.79]	40 [1.58]	M8	M26 x 1.5	¾ Gas (BSPP)	1 <sup>5</sup> / <sub>16</sub> -12UN-2B
		Inlet	20 [0.79]	40 [1.58]	M8	M26 x 1.5	¾ Gas (BSPP)	1 <sup>1</sup> / <sub>16</sub> -12UN-2B
	033	Outlet	27 [1.063]	51 [2.008]	M10	M33x2	1 Gas (BSPP)	1 <sup>5</sup> / <sub>8</sub> -12UN-2B
		Inlet	20 [0.79]	40 [1.58]	M8	M26 x 1.5	¾ Gas (BSPP)	1 <sup>5</sup> / <sub>16</sub> -12UN-2B
	038	Outlet	27 [1.063]	51 [2.008]	M10	M33x2	1 Gas (BSPP)	1 <sup>5</sup> / <sub>8</sub> -12UN-2B
		Inlet	20 [0.79]	40 [1.58]	M8	M26 x 1.5	¾ Gas (BSPP)	1 <sup>5</sup> / <sub>16</sub> -12UN-2B
	044	Outlet	27 [1.063]	51 [2.008]	M10	M33 x 2	1 Gas (BSPP)	1 <sup>5</sup> / <sub>8</sub> -12UN-2B
		Inlet	27 [1.063]	51 [2.008]	M10	M33 x 2	1 Gas (BSPP)	1 <sup>5</sup> / <sub>16</sub> -12UN-2B
	048	Outlet	27 [1.063]	51 [2.008]	M10	M33 x 2	1 Gas (BSPP)	1 <sup>5</sup> / <sub>8</sub> -12UN-2B
		Inlet	27 [1.063]	51 [2.008]	M10	M33 x 2	1 Gas (BSPP)	1 <sup>5</sup> / <sub>16</sub> -12UN-2B
	055	Outlet	27 [1.063]	51 [2.008]	M10	M33 x 2	1 Gas (BSPP)	1 <sup>7</sup> / <sub>8</sub> -12UN-2B
		Inlet	27 [1.063]	51 [2.008]	M10	M33 x 2	1 Gas (BSPP)	1 <sup>5</sup> / <sub>8</sub> -12UN-2B
	063	Outlet	36 [1.417]	62 [2.441]	M10	M42 x 2	1¼ Gas (BSPP)	1 <sup>7</sup> / <sub>8</sub> -12UN-2B
		Inlet	27 [1.063]	51 [2.008]	M10	M33 x 2	1 Gas (BSPP)	1 <sup>5</sup> / <sub>8</sub> -12UN-2B
075	Outlet	36 [1.417]	62 [2.441]	M10	M42 x 2	1¼ Gas (BSPP)	1 <sup>7</sup> / <sub>8</sub> -12UN-2B	
	Inlet	27 [1.063]	51 [2.008]	M10	M33 x 2	1 Gas (BSPP)	1 <sup>5</sup> / <sub>8</sub> -12UN-2B	
090	Outlet	36 [1.417]	62 [2.441]	M10	M42 x 2	1¼ Gas (BSPP)	1 <sup>7</sup> / <sub>8</sub> -12UN-2B	
	Inlet	27 [1.063]	51 [2.008]	M10	M33 x 2	1 Gas (BSPP)	1 <sup>5</sup> / <sub>8</sub> -12UN-2B	



## Anti-cavitation check valve – SNM3GN

### SNM3GN

Turolla offers an optional **integral anti-cavitation check valve** integrated in Group 3 motors bearing blocks. Available for all the displacements, the valve directs internally the flow from the motor outlet to the inlet, when the outlet pressure gets higher than the inlet one.

Valve schematic diagram

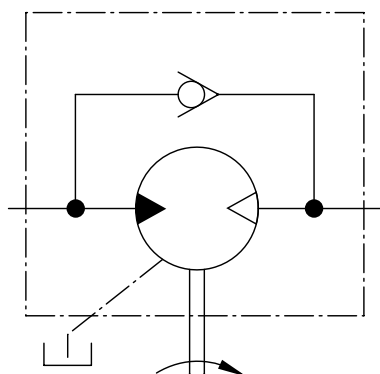

Anticavitation check valve cross section

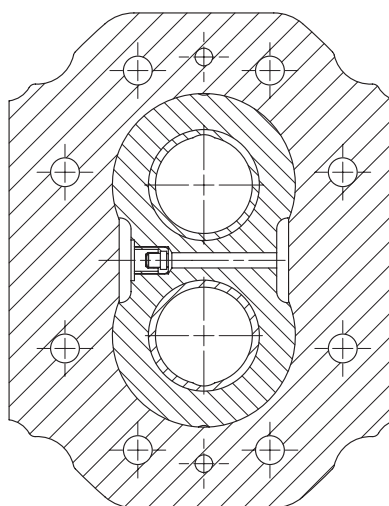



# Dimensions

## SNM3NN, SNU3NN – 01FA, 01DA and 01BA Standard porting drawing for 01FA, 01DA and 01BA

mm  
[in]

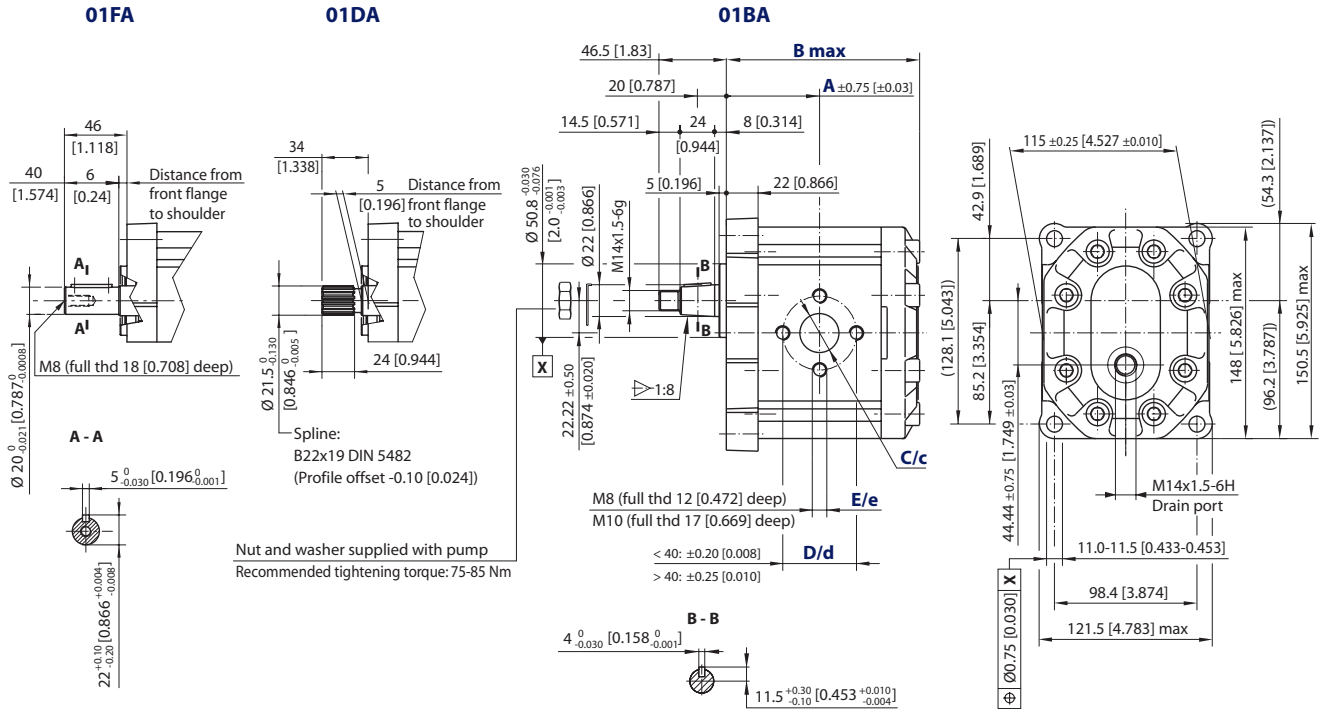

### Bidirectional motors dimensions – 01FA, 01DA and 01BA\*

Frame size	022	026	033	038	044	048	055	063	075	090	
Dimension	<b>A</b>	63.0 [2.480]	64.5 [2.539]	67.0 [2.637]	68.8 [2.708]	71.0 [2.795]	72.5 [2.854]	75.0 [2.952]	78.0 [3.070]	82.0 [3.228]	87.0 [3.425]
	<b>B</b>	132.5 [5.216]	135.5 [5.334]	140.5 [5.531]	144.0 [5.669]	148.5 [5.846]	151.5 [5.964]	156.5 [6.161]	162.5 [6.397]	170.5 [6.712]	180.5 [7.106]
Inlet/Outlet	<b>C/c</b>	20 [0.79]				27 [1.063]					
	<b>D/d</b>	40 [1.58]				51 [2.007]					
	<b>E/e</b>	M8				M10					

\* For unidirectional SNU3NN dimensions, see [SNU3NN ports](#), pages 65 and 66.

For unidirectional motors no case drain hole into the rear cover.

### Model code examples and maximum shaft torque

Flange/drive gear	Model code example	Maximum shaft torque
<b>01FA</b>	SNM3NN/075BN01FAM1CACANNNN/NNNNN	210 N·m [1858 lb·in]
<b>01DA</b>	SNM3NN/026BN01DAM1C7C7NNNNN/NNNNN	290 N·m [2566 lb·in]
<b>01BA</b>	SNM3NN/044BN01BAM1CACANNNN/NNNNN	350 N·m [3097 lb·in]

For further details on ordering, see [Model Code](#), pages 54-58.



**SNM3NN, SNU3NN – 02FA, 02DB and 02AA**  
Standard porting drawing for 02FA, 02DB and 02AA

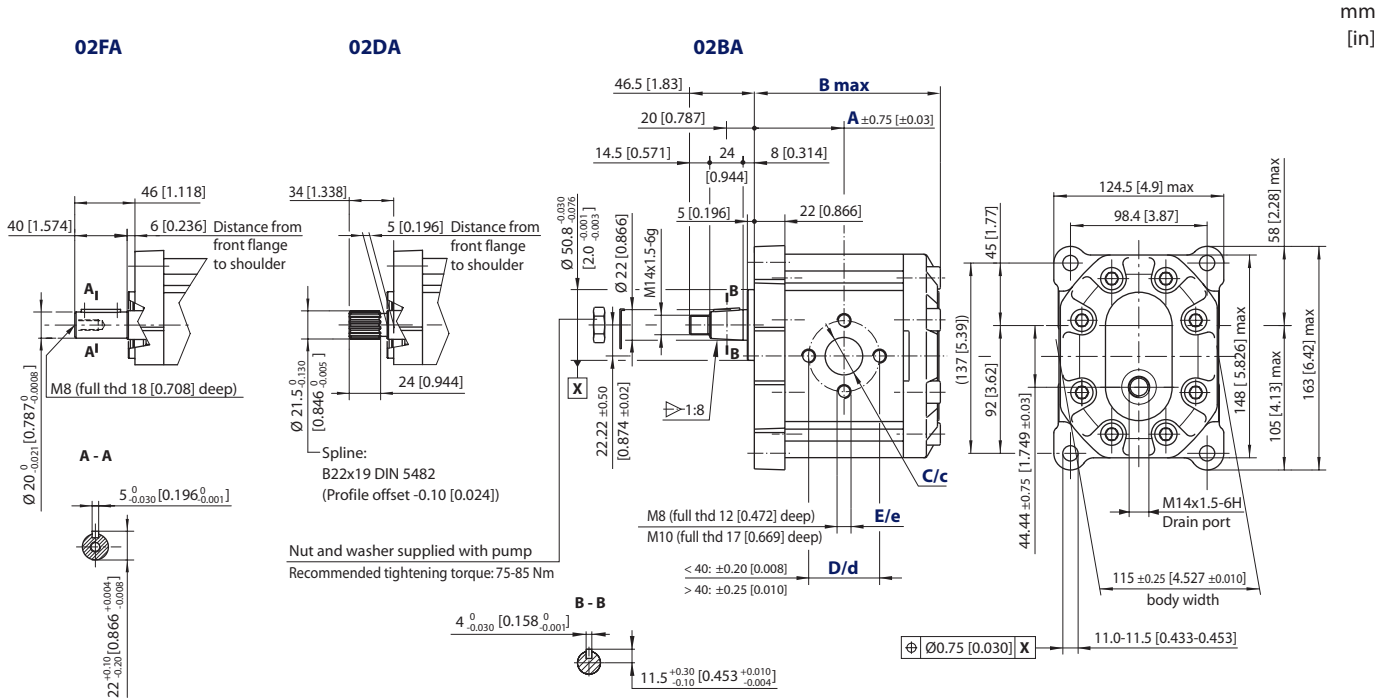

Bidirectional motors dimensions – 02FA, 02DA and 02BA\*

Frame size	022	026	033	038	044	048	055	063	075	090	
Dimension	<b>A</b>	63.0 [2.480]	64.5 [2.539]	67.0 [2.637]	68.8 [2.708]	71.0 [2.795]	72.5 [2.854]	75.0 [2.952]	78.0 [3.070]	82.0 [3.228]	87.0 [3.425]
	<b>B</b>	132.5 [5.216]	135.5 [5.334]	140.5 [5.531]	144.0 [5.669]	148.5 [5.846]	151.5 [5.964]	156.5 [6.161]	162.5 [6.397]	170.5 [6.712]	180.5 [7.106]
Inlet/Outlet	<b>C/c</b>	20 [0.79]			27 [1.063]						
	<b>D/d</b>	40 [1.58]			51 [2.007]						
	<b>E/e</b>	M8			M10						

\* For unidirectional SNU3NN dimensions, see **SNU3NN ports**, pages 65 and 66.

For unidirectional motors no case drain hole into the rear cover.

Model code examples and maximum shaft torque

Flange/drive gear	Model code example	Maximum shaft torque
<b>02FA</b>	SNM3NN/044BN02FAM1CACANNNN/NNNNN	210 N•m [1858 lb•in]
<b>02DA</b>	SNM3NN/033BN02DAM1CACANNNN/NNNNN	290 N•m [2566 lb•in]
<b>02BA</b>	SNM3NN/026BN02BAM1C7C7NNNN/NNNNN	350 N•m [3097 lb•in]

For further details on ordering, see **Model Code**, pages 54-58.



**SNM3NN, SNU3NN – 03FB and 03BB**  
Standard porting drawing for 03FB and 03BB

mm  
[in]

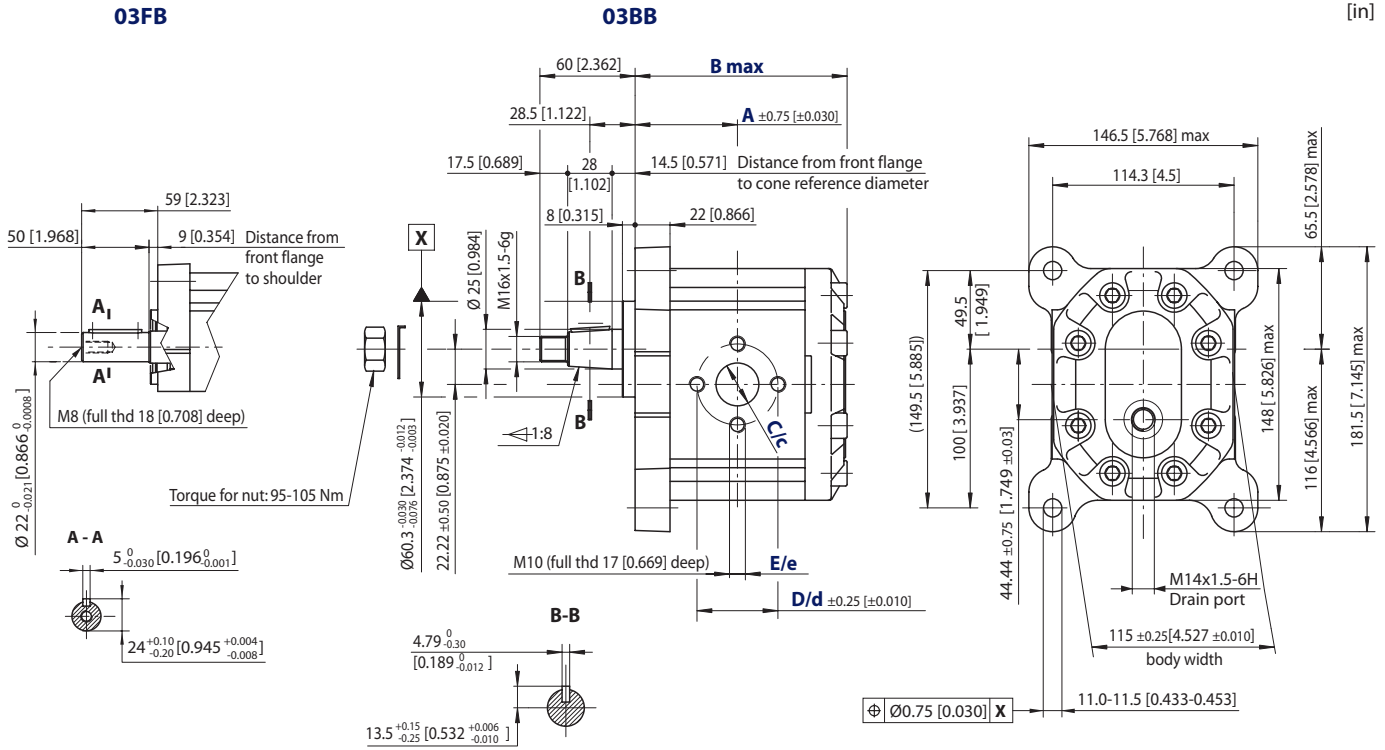

**Bidirectional motors dimensions – 03FB and 03BB\***

Frame size	022	026	033	038	044	048	055	063	075	090	
Dimension	<b>A</b>	61 [2.4]	63 [2.48]	64.5 [2.54]	66.5 [2.62]	69.5 [2.74]	72.5 [2.854]	75 [2.95]	78 [3.07]	82 [3.23]	87 [3.43]
	<b>B</b>	132.5 [5.22]	135.5 [5.33]	140.5 [5.53]	144.0 [5.67]	148.5 [5.85]	151.5 [5.96]	156.5 [6.16]	162.5 [6.4]	170.5 [6.71]	180.5 [7.11]
Inlet/Outlet	<b>C/c</b>	18 [0.71]			27 [1.063]						
	<b>D/d</b>	55 [2.16]									
	<b>E/e</b>	M8									

\* For unidirectional SNU3NN dimensions, see [SNU3NN ports](#), pages 65 and 66.

For unidirectional motors no case drain hole into the rear cover.

**Model code examples and maximum shaft torque**

Flange/drive gear	Model code example	Maximum shaft torque
<b>03FB</b>	SNM3NN/063BN03FBM1CACANNNN/NNNNN	300 N·m [2655 lb·in]
<b>03BB</b>	SNM3NN/090BN03BBM1CACANNNN/NNNNN	500 N·m [4425 lb·in]

For further details on ordering, see [Model Code](#), pages 54-58.



**SNM3NN, SNU3NN – 06AA**  
Standard porting drawing for 06AA

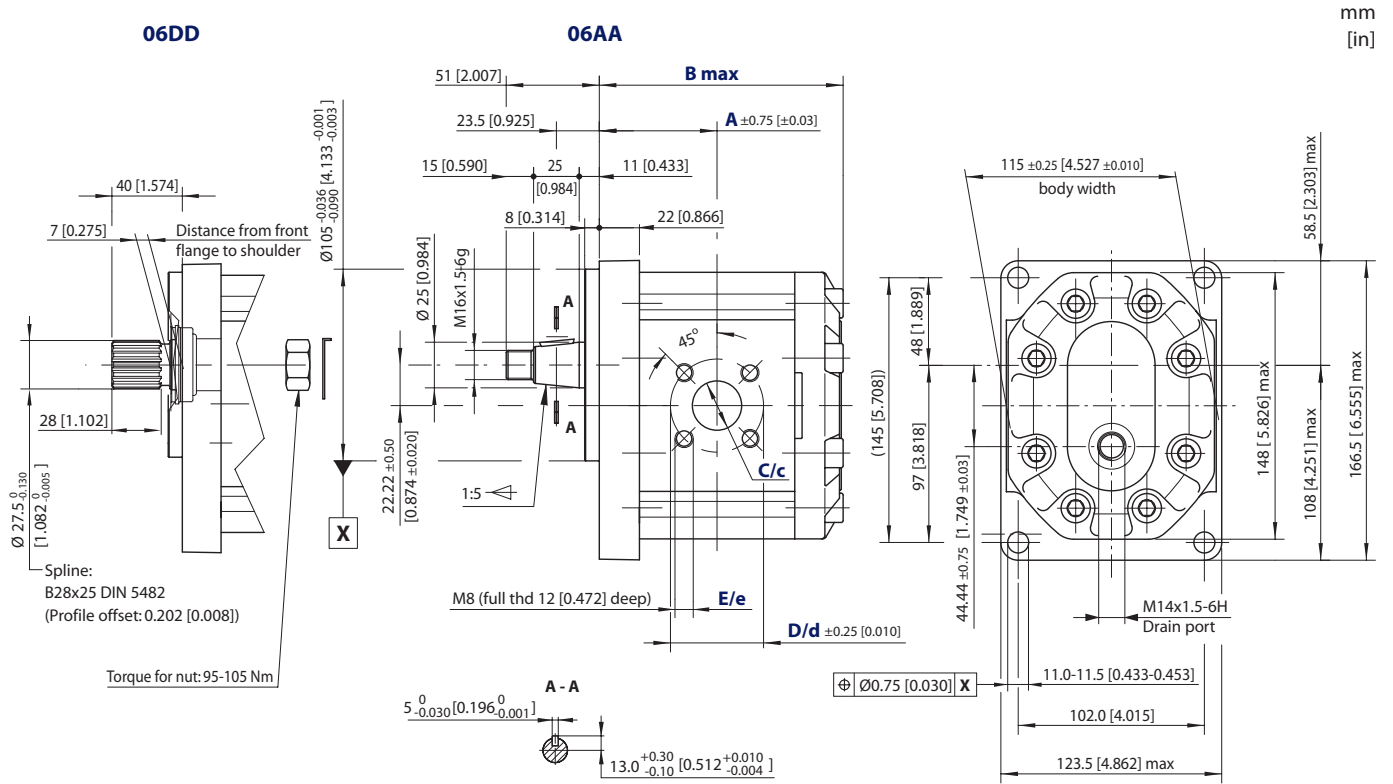

Bidirectional motors dimensions – 06DD AND 06AA \*

Frame size	022	026	033	038	044	048	055	063	075	090	
Dimension	<b>A</b>	63.0 [2.480]	64.5 [2.539]	67.0 [2.637]	68.8 [2.708]	71.0 [2.795]	72.5 [2.854]	75.0 [2.952]	78.0 [3.070]	82.0 [3.228]	87.0 [3.425]
	<b>B</b>	132.5 [5.216]	135.5 [5.334]	140.5 [5.531]	144.0 [5.669]	148.5 [5.846]	151.5 [5.964]	156.5 [6.161]	162.5 [6.397]	170.5 [6.712]	180.5 [7.106]
Inlet/Outlet	<b>C/c</b>	20 [0.79]			27 [1.063]						
	<b>D/d</b>	40 [1.58]			51 [2.007]						
	<b>E/e</b>	M8			M10						

\* For unidirectional SNU3NN dimensions, see **SNU3NN ports**, pages 65 and 66.

For unidirectional motors no case drain hole into the rear cover.

Model code examples and maximum shaft torque

Flange/drive gear	Model code example	Maximum shaft torque
<b>06DD</b>	SNM3NN/044BN06DDM1BBBBNNNN/NNNN	300 N·m [2655 lb·in]
<b>06AA</b>	SNM3NN/022BN06AAM1BABANNNN/NNNN	450 N·m [3982 lb·in]

For further details on ordering, see **Model Code**, pages 54-58.



**SNM3NN, SNU3NN – 07BC, 07SA and 07GA**  
Standard porting drawing for 07BC, 07SA and 07GA

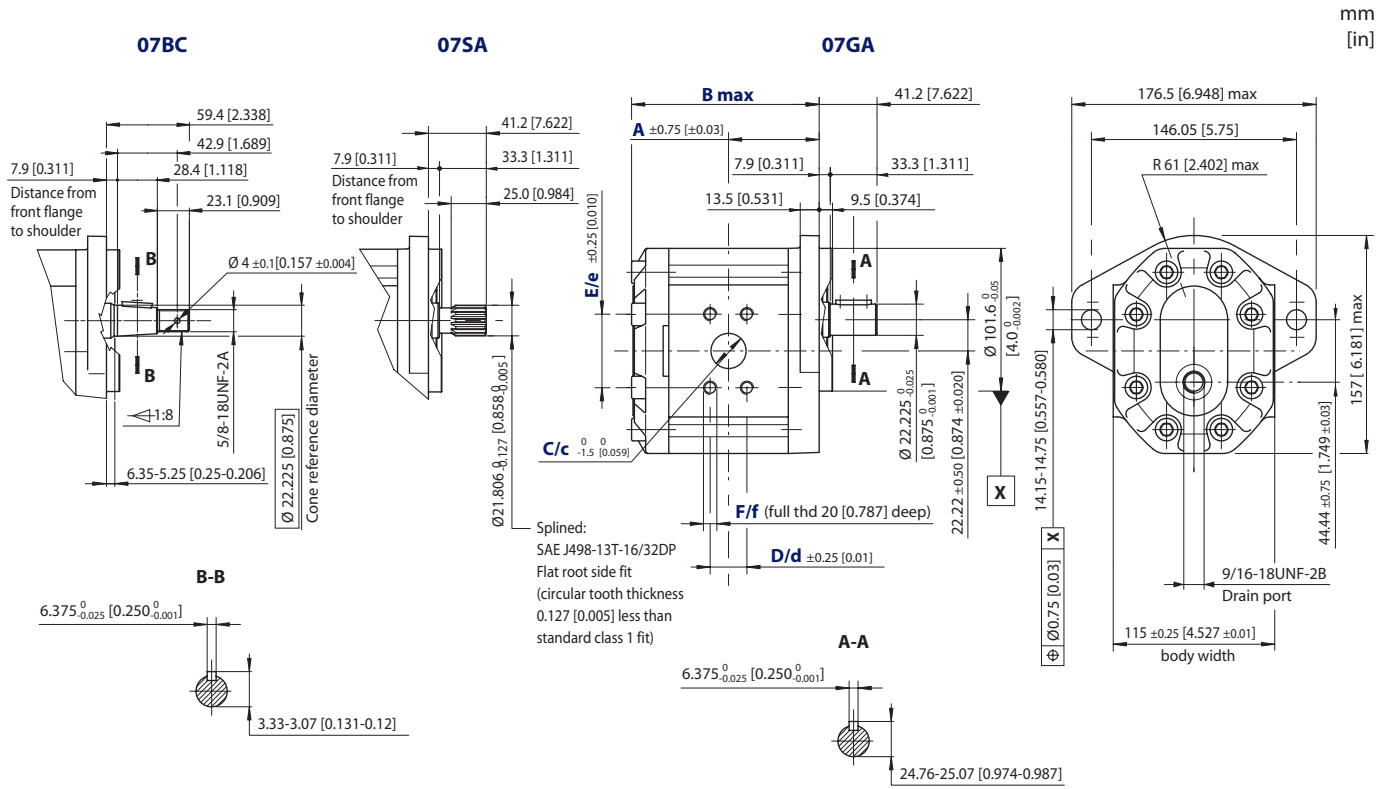

**Bidirectional motors dimensions – 07BC, 07SA and 07GA\***

Frame size	022	026	033	038	044	048	055	063	075	090	
Dimension	<b>A</b>	63.0 [2.480]	64.5 [2.539]	67.0 [2.637]	68.8 [2.708]	71.0 [2.795]	72.5 [2.854]	75.0 [2.952]	78.0 [3.070]	82.0 [3.228]	87.0 [3.425]
	<b>B</b>	132.5 [5.216]	135.5 [5.334]	140.5 [5.531]	144.0 [5.669]	148.5 [5.846]	151.5 [5.964]	156.5 [6.161]	162.5 [6.397]	170.5 [6.712]	180.5 [7.106]
Inlet/Outlet	<b>C/c</b>	25.4 [1]			31.8 [1.251]						
	<b>D/d</b>	26.19 [1.031]			30.18 [1.188]						
	<b>E/e</b>	52.37 [2.061]			58.72 [2.311]						
	<b>F/f</b>	3/8-16UNC-2B			7/16-14UNC-2B						

\* For unidirectional SNU3NN dimensions, see [SNU3NN ports](#), pages 65 and 66.

For unidirectional motors no case drain hole into the rear cover.

**Model code examples and maximum shaft torque**

Flange/drive gear	Model code example	Maximum shaft torque
<b>07BC</b>	SNM3NN/026BN07BCM6A3A3NNNN/NNNN	300 N·m [2655 lb·in]
<b>07SA</b>	SNM3NN/063BN07SAM6A4A4NNNN/NNNN	270 N·m [2389 lb·in]
<b>07GA</b>	SNM3NN/090BN07GAM6A4A4NNNN/NNNN	230 N·m [2035 lb·in]

For further details on ordering, see [Model Code](#), pages 54-58.





# Notes



# Notes



# Notes

**Italy**

Via Villanova 28  
40055 Villanova di Castenaso  
Bologna, Italia  
Telephone: +39 051 6054 411

**U.S.A.**

2800 East 13th Street  
Ames, IA 50010, USA  
Phone: +1 515 239 6677  
Fax: +1 515 239 6618

**Slovakia**

Kukučínova 2148-84  
01701 Považská Bystrica, Slovakia  
Phone: +421 424 301 202  
Fax: +421 424 301 626

E-mail: [turollaocg@turollaocg.com](mailto:turollaocg@turollaocg.com)

[www.turollaocg.com](http://www.turollaocg.com)

Local address

